

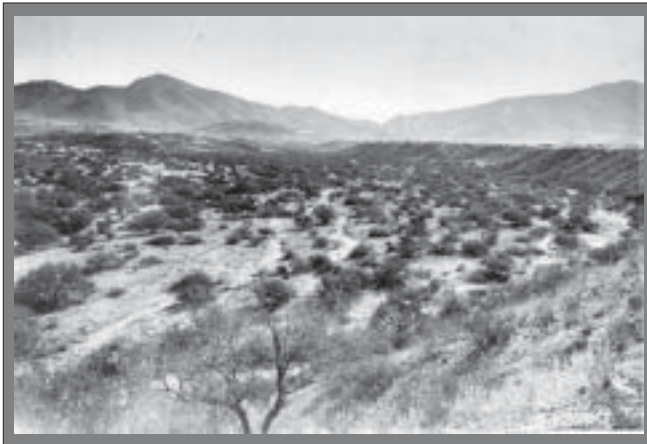

Santa Rita Experimental Range: 100 Years (1903 to 2003) of Accomplishments and Contributions

Conference Proceedings
October 30–November 1, 2003
Tucson, AZ



1902



2003



Abstract

McClaran, Mitchel P.; Ffolliott, Peter F.; Edminster, Carleton B., tech. coords. 2003. **Santa Rita Experimental Range: 100 years (1903 to 2003) of accomplishments and contributions**; conference proceedings; 2003 October 30–November 1; Tucson, AZ. Proc. RMRS-P-30. Ogden, UT: U.S. Department of Agriculture, Forest Service, Rocky Mountain Research Station. 197 p.

The purpose of this conference was to celebrate the 100 years of accomplishments and contributions of the Santa Rita Experimental Range, the longest continuously operating research area dedicated to the sustainable management of North American rangelands. The conference consisted of one-and-a-half days of invited synthesis papers and contributed poster presentations and a 1-day field trip to research sites at the Santa Rita Experimental Range. A forecast of the future contributions of this historical site were also considered. This conference provided a forum for people to share their knowledge, experiences, and opinions about the contributions that the Santa Rita Experimental Range has made to rangeland management.

Keywords: long-term research, livestock grazing, vegetation, soils, erosion, cultural resources

You may order additional copies of this publication by sending your mailing information in label form through one of the following media. Please specify the publication title and Research Paper number.

Fort Collins Service Center

Telephone	(970) 498-1719
FAX	(970) 498-1660
E-mail	rschneider@fs.fed.us
Web site	http://www.fs.fed.us/rm
Mailing Address	Publications Distribution Rocky Mountain Research Station 240 W. Prospect Road Fort Collins, CO 80526

NOTE: Papers were edited to a uniform style; however, authors are responsible for the content and accuracy of their papers.

Cover photographs: Top pair are looking east into Box Canyon from photo station PS 222, June 1902 and May 2003. Bottom pair are looking west at Huerfano Butte from photo station 233, 1902 (month unknown) and May 2003.

Rocky Mountain Research Station
324 25th Street
Ogden, UT 84401

Santa Rita Experimental Range: 100 Years (1903 to 2003) of Accomplishments and Contributions

**Conference Proceedings
October 30–November 1, 2003
Tucson, AZ**

Technical Coordinators _____

Mitchel P. McClaran is Professor of Range Management, School of Renewable Natural Resources, 325 Biological Sciences East, University of Arizona, Tucson, AZ 85721.

Peter F. Ffolliott is Professor, School of Renewable Natural Resources, 325 Biological Sciences East, University of Arizona, Tucson, AZ 85721.

Carleton B. Edminster is Project Manager with the USDA Forest Service, Rocky Mountain Research Station, Flagstaff Lab, 2500 South Pine Knoll, Flagstaff, AZ 86011.

Sponsors _____

Rocky Mountain Research Station, USDA Forest Service
USDA Natural Resources Conservation Service
USDA Agricultural Research Service
School of Renewable Natural Resources, University of Arizona
College of Agriculture and Life Sciences, University of Arizona
International Arid lands Consortium
Arizona State Land Department
Society for Range Management

Preface

These peer-reviewed proceedings represent a permanent record of this conference, celebrating the accomplishments and contributions of the Santa Rita Experimental Range, the longest continuously operating research area dedicated to the sustainable management of North American rangelands, and forecasts the future contributions of this historical site. The conference consisted of the presentation of a series of synthesis papers by invited speakers who reviewed significant research findings on the Santa Rita Experimental Range and, where appropriate, forecast future research opportunities. Contributed poster papers supplemented and expanded on the synthesis papers by reporting on recently completed or ongoing research on the Santa Rita. The conference concluded with a 1-day field trip to research sites on the Santa Rita Experimental Range.

This conference provided a forum for researchers, managers and practitioners, decisionmakers, and other interested people to share their knowledge, experiences,

and opinions about the contributions that the Santa Rita Experimental Range has made to rangeland management in the Southwestern United States. The conference and these proceedings also represent a starting point for planning and implementing research activities, leading to improved, ecosystem-based, multiple-use rangeland management in the future.

The technical coordinators of these proceedings acknowledge the collective efforts of the technical reviewers of these papers. We also acknowledge Louise Kingsbury, Group Leader, and the Publishing Services staff, Rocky Mountain Research Station, USDA Forest Service, Ogden, UT, for their invaluable editorial assistance. Major funding for the preparation of these proceedings was provided by the Southwestern Borderlands Project (FS-RMRS-4651), Rocky Mountain Research Station, USDA Forest Service, Flagstaff, AZ. Additional support was furnished by the other sponsors of the conference.

Mitchel P. McClaran
Peter F. Ffolliott
Carleton B. Edminster

Contents

Page

Invited Papers

Nathan F. Sayre	Recognizing History in Range Ecology: 100 Years of Science and Management on the Santa Rita Experimental Range	1
Mitchel P. McClaran	A Century of Vegetation Change on the Santa Rita Experimental Range	16
George B. Ruyle	Rangeland Livestock Production: Developing the Concept of Sustainability on the Santa Rita Experimental Range	34
Peter F. Ffolliott	Vegetation Management Practices: Past and Present	48
Gerald J. Gottfried		
William H. Kruse		
Paul R. Krausman	Wildlife Ecology and Management, Santa Rita	59
Michael L. Morrison	Experimental Range (1903 to 2002)	
John H. Madsen	Cultural Resources of the Santa Rita Experimental Range	68
Bruce D. Munda	Revegetation Practices on the Santa Rita Experimental Range	80
Mark J. Pater		
Leonard J. Lane	Hydrology and Soil Erosion	92
Mary R. Kidwell		
Thomas E. Sheridan	Archive and Laboratory Embedded in the Landscape: Future of the Santa Rita Experimental Range	101

Poster Papers

Michael A. Crimmins	Climate Variability and Plant Response at the Santa Rita Experimental	
Theresa M. Mau-Crimmins	Range, Arizona	111
Erika Geiger	Spread of a Nonnative Grass Across Southern Arizona:	
Theresa Mau-Crimmins	Multiple Data Sources to Monitor Change	116
Heather Schussman		
Jorry Z. U. Kaurivi	Multitemporal MODIS-EVI Relationships With Precipitation and	
Alfredo R. Huete	Temperature at the Santa Rita Experimental Range	121
Kamel Didan		
Alessandra Fravolini	Role of Soil Texture on Mesquite Water Relations and Response to	
Kevin R. Hultine	Summer Precipitation	125
Dan F. Koepke		
David G. Williams		
Stacy Pease	Mesquite Removal and Mulching Treatment Impacts on Herbage	
Peter F. Ffolliott	Production and Selected Soil Chemical Properties	130
Leonard F. DeBano		
Gerald J. Gottfried		
Alvin L. Medina	Gambel and Scaled Quail Diets on the Santa Rita Experimental Range	133
Alvin L. Medina	Historical and Recent Flora of the Santa Rita Experimental Range	141
Sharon H. Biedenbender	Effects of Neighbor Species and Distance on 2- and 4-Year Survival of	
Mitchel P. McClaran	Lehmann Lovegrass and Native Grasses	149
Bruce A. Roundy		

Peter F. Ffolliott Jeffrey O. Dawson James T. Fisher Itshack Moshe Timothy E. Fulbright W. Carter Johnson Paul Verburg Muhammad Shatanawi Jim P. M. Chamie	International Arid Lands Consortium: A Synopsis of Accomplishments	154
Donald J. Breckenfeld Daniel Robinett	Soil and Ecological Sites of the Santa Rita Experimental Range	157
Gerald J. Gottfried Peter F. Ffolliott Pablo Garcia Diego Valdez-Zamudio Akram Al-Khoury	Assessment of Fire-Damaged Mesquite Trees 8 Years Following an Illegal Burn	166
Larry D. Howery Bruce D. Munda Dan G. Robinett Harry H. Buck	Sweet Resin Bush on the Santa Rita Experimental Range: An Eradication Effort	169
A. Karim Batchily Donald F. Post R. B. Bryant Donald J. Breckenfeld	Spectral Reflectance and Soil Morphology Characteristics of Santa Rita Experimental Range Soils	175
Phil R. Ogden E. Lamar Smith	Cow Weights and Calf Production for Pasture 12-C Lehmann Lovegrass Grazing Trials, 1982 to 1993	183
Nathan B. English David G. Williams Jake F. Weltzin	Soil Temperature and Moisture Dynamics After Experimental Irrigation on Two Contrasting Soils on the Santa Rita Experimental Range: Implications for Mesquite Establishment	188
Craig Wissler Deborah Angell	New Data Sources and Derived Products for the SRER Digital Spatial Database	193

Recognizing History in Range Ecology: 100 Years of Science and Management on the Santa Rita Experimental Range

Abstract: At the centennial of the Santa Rita Experimental Range, historical analysis is called for on two levels. First, as a major site in the history of range ecology, the Santa Rita illuminates past successes and failures in science and management and the ways in which larger social, economic, and political factors have shaped scientific research. Second, with the turn away from equilibrium-based models in range science—a turn prompted in part by research at the Santa Rita—there is a growing need for history in range ecology itself. I discuss the needs, premises, and events underlying establishment of the Santa Rita in 1903. Then I examine the evolution of research and management recommendations through four major periods from 1901 to 1988, and I discuss the land swap that transferred the Santa Rita to State ownership in 1988 to 1991. Finally, I consider what effects the Santa Rita has had on rangelands and range management in the region. I argue that a static conception of the carrying capacity of Southwestern rangelands was imposed for economic and political reasons, over the objections or reservations of early range scientists at the Santa Rita, and that this may have contributed both to range depletion and to rancorous relations between public agencies and private ranchers in the twentieth century. To meet society's current demands on rangelands, the long-term, large-scale data assembled from the Santa Rita will be critically important.

Keywords: range science, range ecology, history, carrying capacity, mesquite, Frederic Clements, semiarid rangelands

Acknowledgments: The author gratefully acknowledges Joel Brown, Kris Havstad, Mitchel P. McClaran, Guy McPherson, and especially Phil Ogden for helpful comments and other assistance in the preparation of the manuscript. Thanks also to Barbara Gibson for help with the figures. I remain wholly responsible for the contents.

Introduction

The Santa Rita Experimental Range is 100 years old this year, providing an occasion to celebrate and to reflect. The first of many experimental ranges in the United States, the Santa Rita was founded at a time when both range science and plant ecology were in their infancy. The purpose was to conduct research that would aid in the management of Southwestern rangelands by public agencies and private ranchers, in the belief that science, coordinated by public agencies and conducted on a suitably large scale, would produce methods of restoring and conserving the vast and severely degraded rangelands of the region more quickly and effectively than a private, trial-and-error approach could. Confidence in the ability of government science to solve pressing public problems was characteristic of the era, giving birth not only to the Santa Rita but also to range science more generally and to an array of Federal agencies.

To assess a century of work on the Santa Rita, at least two questions must be answered: (1) What happened on the experimental range itself, in terms of research and recommendations for management? And (2) what effects did this work have on rangelands in the region? The historical record is abundant regarding the first question, but comparatively thin as to the second. I begin by reviewing the circumstances surrounding the creation of the Santa Rita Experimental Range. Then I use the more than 400 publications produced from the Santa Rita to define four major periods of research from 1901

Nathan F. Sayre is Postdoctoral Research Associate with the Jornada Experimental Range in Las Cruces, NM. Phone: 520-327-5567; e-mail: Nfsayre@aol.com. He earned a B.A. degree in philosophy from Yale University and a Ph.D. degree in anthropology from the University of Chicago. His research focuses on the history of range science and management in the Southwest, and the implications of that history for current management.

In: McClaran, Mitchel P.; Ffolliott, Peter F.; Edminster, Carleton B. tech. coords. Santa Rita Experimental Range: 100 years (1903 to 2003) of accomplishments and contributions; conference proceedings; 2003 October 30–November 1; Tucson, AZ. Proc. RMRS-P-30. Ogden, UT: U.S. Department of Agriculture, Forest Service, Rocky Mountain Research Station.

to 1988. Within each period, I examine selected documents—some published, some unpublished—to trace the evolution of research questions and management recommendations. Then I briefly discuss the period since 1988, when ownership of the range changed from Federal to State. Finally, I examine the evidence regarding actual management and range conditions over the past 100 years. Although the degree of influence of the Santa Rita is difficult to determine in detail, several themes and possible lessons for the future emerge nevertheless.

The overarching thesis of my argument is that a century of research at the Santa Rita indicates the need for historical analysis both *of* and *in* range ecology. Understanding the history *of* range ecology is important for the same reasons as in any discipline: to learn from past failures and successes, to recognize intellectual antecedents, and to enable critical reflection on our own ideas and practices. The history of the Santa Rita reveals that while the methods and emphases of research changed to reflect accumulating knowledge, the central questions and many management recommendations remained surprisingly consistent until very recently; it also suggests that institutional and political factors have been as important as scientific or ecological ones in shaping the knowledge that researchers produce. The importance of history *in* range ecology emerges from what has been learned in the past century, both at the Santa Rita and in other arid and semiarid settings. Whereas equilibrium-based ecological theory allowed most past researchers to neglect historical questions, current theories emphasize the potential of nonstationary climate and discrete events, interacting at various spatial and temporal scales, to cause significant and lasting ecological change. Today, with the larger social, political, and economic contexts of range management dramatically different from a century ago, there is a need both to recognize and to re-cognize history, so that the changes of the past can be properly understood and the challenges of the present and future effectively confronted.

Beginnings: Founding a Range Research Reserve

Nineteen hundred and three was the fifth year of a 6-year drought in southern Arizona. The boom and bust cycles of markets and rainfall were already painfully familiar to both ranchers and public officials in the area. Just 10 years before, the drought of 1891 to 1893 had killed scores of thousands of cattle and wiped out countless ranchers. That drought, more than the one from 1898 to 1904, helped to set in motion the factors that would eventuate in the Santa Rita Experimental Range. But it was not the only, or the first, factor.

The Hatch Act of 1887 authorized State and territorial governments to receive Federal funding for agricultural experiment stations. Lacking other resources, the University of Arizona took advantage of Hatch Act funds beginning in 1890, using them to cover operating expenses and salaries as well as agricultural research (Webb 2002: 80). A year later the Arizona Agricultural Experiment Station published its Bulletin number 2, comprising two short articles by J. W. Toumey (1890): "Arizona Range Grasses in General" and "Overstocking the Range." The latter article

contained a prescient warning. In the open range, Toumey wrote (1890: 7):

...even the hardiest grasses when continually eaten close to the ground will, as a rule, in a few years become extinct... [W]here drought and overstocking both combine, and the grass that does not burn out from the effects of the hot sun, is continually eaten close to the ground by hungry cattle, the range is in poor condition to produce feed for the following season. The repetition of this process year after year cannot help but decrease the supply of grasses on the range.

By the time the drought broke in late summer 1893, an estimated 50 to 75 percent of southern Arizona's cattle had perished from lack of feed or water. Photographs from the time bear out Toumey's most dire scenario (fig. 1).

The undeniable ecological and economic damage of the drought helped get the attention of Congress, which in 1895 appropriated the first Federal funding expressly for range research. In the Texas high plains, Jared Smith and H. L. Bentley arranged to fence two sections of rangeland



Figure 1—Photograph taken by George Roskruege, surveyor for the General Land Office, at an unidentified southeastern Arizona location in the summer of 1891. Heavy, uncontrolled grazing combined with drought produced widespread denudation of rangelands previously dominated by perennial bunchgrasses, eventually prompting Congressional action to regulate grazing on the public domain and to create experimental ranges such as the Santa Rita (courtesy of Arizona Historical Society, Tucson, AHS #45866).

for experiments funded by these monies. It was not until 5 years later, however, that the Federal government took the decisive step of reserving land from the public domain specifically for range research. President McKinley signed the order withdrawing four sections southeast of Tucson on October 10, 1900.

David Griffiths of the Arizona Agricultural Experiment Station had spent “the greater part of a week” scouting the Tucson basin for this tract of land (Griffiths 1901: 23). That it was bisected by the Southern Pacific Railroad was an advantage in his eyes, because it meant that one side of his research plot was already fenced. He enclosed 52 acres, divided it into 60 plots, and began a series of experiments. But the “small inclosure” [sic], as it came to be called, soon showed serious limitations. Even including the unfenced portion, it was too small and too uniform to represent the varied rangelands of the region. It was also lower and drier than the prime grasslands south and east of the Tucson basin. Griffiths tried to assert that the area was “a typical mesa region in every respect” (1901: 24), but it contained more creosote and cacti than perennial grasses and little topographical, climatic, or edaphic variation. “The production of forage is so small here, at best, that one is obliged to measure his pasture by square miles rather than by acres,” he noted, “and the operations in range improvement must be on a correspondingly large scale” (1901: 29). Even if Griffiths’ experiments in establishing forage plants had succeeded, the need for a larger research range would have remained.

In 1902, Alfred Potter—who would shortly become Gifford Pinchot’s first Chief of Grazing—drafted a report for the proposed Santa Rita Forest Reserve, from which the experimental range would subsequently be carved (Potter 1902). In its earliest conception, the reserve was to extend from the Santa Cruz River east to Cienega Creek, and from the Southern Pacific Railroad south to Sonoita Creek, an area of 592 square miles or 379,000 acres. Potter acknowledged that only 45,000 acres of this area was “well forested,” and that nearly four-fifths of it was mesa and foothills land. Most of the lower elevation, nontimber land was eventually excluded from the reserve, but on the northwest flank of the Santa Rita Mountains parts of four townships were withdrawn, giving birth to the Santa Rita Experimental Range; Griffiths termed it “the large inclosure” [sic]. President Theodore Roosevelt signed the proclamation on April 11, 1902. The boundaries expanded under subsequent executive orders, by Roosevelt in 1907, Taft in 1910, and by Coolidge twice, in 1925 and 1927. Taft’s order also recognized the Santa Rita as distinct from the adjacent Forest Reserve, which had been consolidated into the Coronado National Forest 2 years before; in consequence, title to the experimental range remained with the Interior Department, rather than transferring to the Department of Agriculture. Ultimately, the Santa Rita encompassed over 53,000 acres, or more than 1,000 times the size of Griffiths’ first enclosure (which was converted to military uses in 1925 and today is part of Davis-Monthan Air Force Base).

Two of Potter’s observations about the Santa Rita Forest Reserve are worth noting here. First, he wrote that before the 1891 to 1893 drought, the area had “carried fully 25,000 head of cattle and horses and 5,000 sheep,” and that as of

1902 these numbers had dropped to “between 7,000 and 8,000 cattle, from 1,000 to 2,000 horses, and about 4,000 sheep.” These figures translate to roughly 44 head per section before 1891, and 15 to 18 head per section in 1902. Potter also described a seasonal pattern of movement within the proposed reserve, with herds concentrating in the mountains in the fall and winter and the foothills in the spring and summer.

Second, Potter reported that “the mesa lands are all covered with mesquite, to a certain extent; although over the greater part of the area the growth is very scattering and shrubby in character. The only good solid mesquite area is along close to the river bottom and in the draws coming down from the mountains.” He described mesquite as “the most universally useful tree in this section,” providing almost all the firewood and fence posts used in the vicinity. Since many wells at this period relied on steam pumps fueled with wood (Griffiths 1904: 35), it is possible that mesquite harvesting may have invisibly skewed later perceptions of the area’s “original” vegetation.

Between March and June 1903, 27.3 miles of fence were constructed around the experimental range, at a cost of \$105 per mile. For the next 12 years, no livestock would graze on some 49 sections of land, while Griffiths and his successors studied its recovery. Spanning more than 2,600 ft of elevation, the new reserve encompassed significant gradients of rainfall, temperature, soils, and vegetation. At the highest, most productive edge of the reserve, another nine sections of land were included in the experimental range but were allowed to remain in the management of settlers already established there: McCleary, MacBeath, Proctor, and Ruelas. Their pastures, ranging in size from 194 to 1,695 acres, were fenced by 1908 and served comparative purposes for the researchers, suggesting how recovery proceeded under controlled grazing.

That the founding management act of the Santa Rita Experimental Range was fencing its perimeter is emblematic of circumstances at the time. There had been livestock in the Santa Cruz Valley for 200 years, and for most of that time they had not constituted a problem, as far as we know. Limited transportation and markets, along with notorious insecurity, had largely isolated the region from outside sources of livestock, and herd growth had been determined mainly by local conditions of forage, water, disease, and predation. Only in the last quarter-century had the cattle boom flooded the region with livestock from elsewhere, brought in on foot or by railroad and financed from afar. In 1903, leases and fences were not yet in place to regulate competition for forage on Federal lands, but there was finally a political consensus that access to the range had to be controlled, and that fencing was the only practicable way to do this. Many early reports implied that fencing, in and of itself, would cause range conditions to improve; fences went up on forest lands after 1905, on State Trust lands after 1912, and on the remaining public domain after 1934. The expanded scale of the livestock industry, from local to international, entailed a contraction of the scale of the individual herd—from entire valleys or mountain ranges to defined and fenced pastures. Almost without exception, research on the Santa Rita would take this geographical innovation for granted.

Periods of Santa Rita Research

With the range fenced, David Griffiths could begin his research, initiating the stream of publications by which the Santa Rita's scientific production can be appraised. Al Medina's (1996) bibliography of Santa Rita research publications lists 452 articles spanning the period 1901 to 1988. This figure includes 18 undated leaflets and several duplicate entries; excluding these and adding one important reference omitted by Medina (see below), we have a data set of 427 articles. If we organize these chronologically, and depict the results graphically (fig. 2), several periods of research activity can be identified. This periodization is intended as a heuristic device only; there have always been multiple threads of inquiry, administration, and funding in the fabric of the Santa Rita, and the variable lag between defining, funding, conducting, and publishing research defies neat temporal separation.

It is immediately clear from the graph that wildlife has been an important focus of research on the Santa Rita since the 1920s, increasingly so in recent decades. But it has

rarely constituted a majority of publications, and its very consistency makes it poorly suited as a means of distinguishing periods of research effort. I defer to Krausman (this proceedings) to illuminate the place of wildlife research in the history of the Santa Rita. The history of research on Lehmann lovegrass is not as long, but otherwise similar to wildlife—recurrent but minor from the 1940s through the 1980s. I will touch upon it along the way.

1901 to 1931: Institutional Consolidation, Revegetation, and Carrying Capacity

In the first 30 years of the Santa Rita, only 19 articles were published, never more than two in any one year. This was a period of minimal funding and staffing of the range, while the larger institutional basis for range research was slowly being consolidated. Major events in this consolidation process included the transfer of the Forest Reserves to the U.S. Department of Agriculture and the formation of the Forest Service in 1905; the creation of the Office of Grazing Studies within the Forest Service in 1910, followed a year later by the subdivision of forest administration into

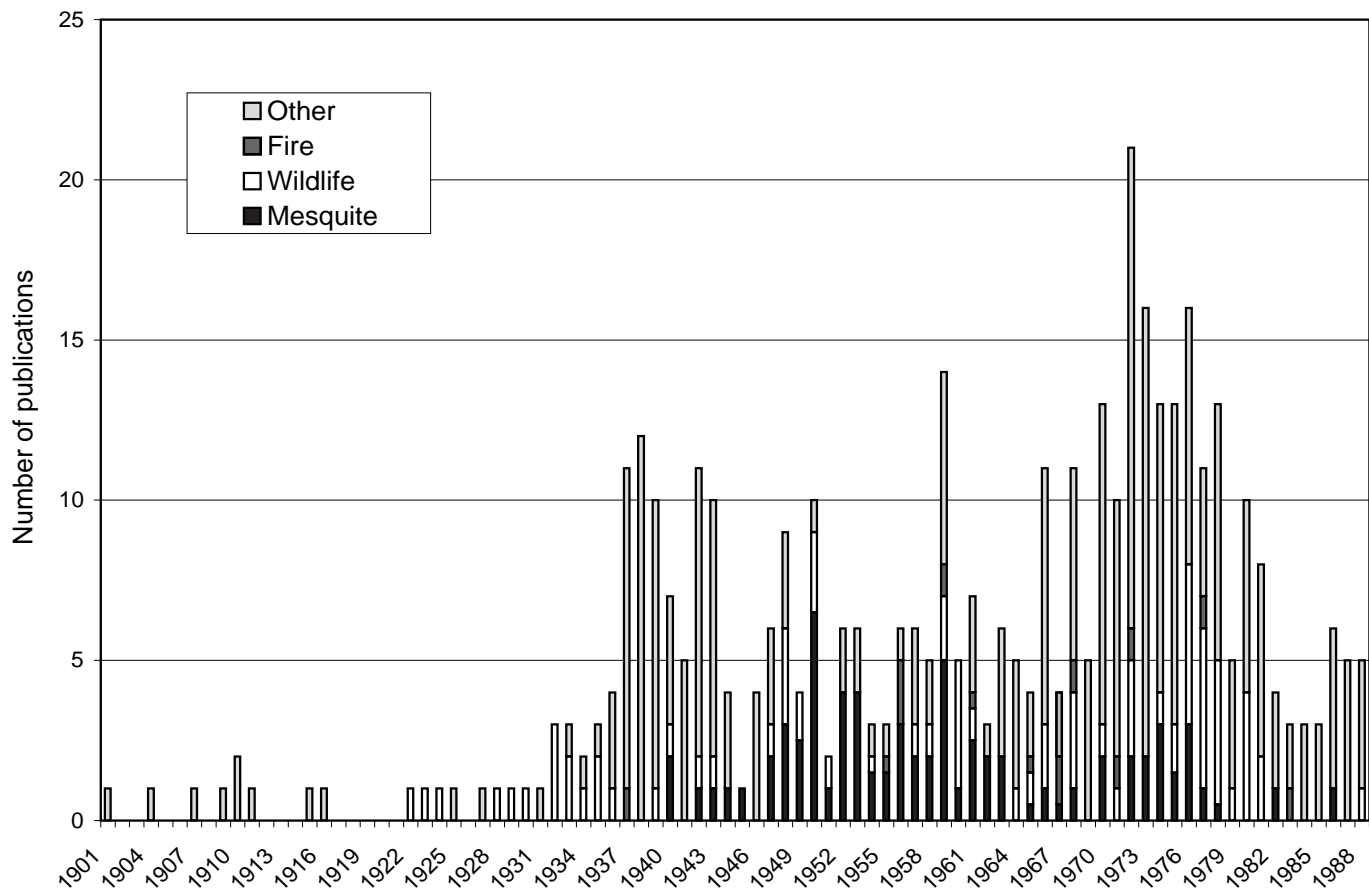

Figure 2—Annual output of publications from Santa Rita research, 1901 to 1988, organized topically. Half-units reflect publications that expressly covered two topics together (for example, mesquite and fire) (adapted from Medina 1996).

regional offices; the transfer of range research outside National Forests—including the Santa Rita Experimental Range—from the Bureau of Plant Industry to the Forest Service in 1915; the transfer of the Office of Grazing Studies from the Branch of Grazing to the Branch of Research in 1926; and finally, the creation of regional forest and range experiment stations under the McSweeney-McNary Forest Research Act of 1928 (Chapline 1944). It was this last event that created the Southwestern Forest and Range Experiment Station (SWFRES), based in Tucson, which brought increased Federal funding for range research and triggered the rise in Santa Rita publications from 1932 on.

Two pressing issues dominated the research of this period: (1) how to restore forage plants decimated by the cattle boom, and (2) how to measure range resources for management and administration. Griffiths (1901, 1904, 1907) and J. J. Thornber (1910) tested hundreds of native and nonnative plant species in hopes of finding economical ways of artificially establishing cover and forage on bare or nearly bare ground. Most failed altogether, and even those that showed some success were failures in economical terms. Building up berms of soil to slow runoff and capture seed was also attempted at the small enclosure, but the structures often blew out in floods and did not result in enough grass to justify the costs. “Much more satisfactory results have thus far been obtained by husbanding the native vegetation and grazing well within the capacity of the land to maintain stock” than by any other methods, Griffiths (1910: 13) concluded. This recommendation against overgrazing has been a consistent refrain from Santa Rita researchers ever since, although far less simple than it appears.

Determining carrying capacities was central to the research of this period because it linked environmental and ecological factors to political and economic imperatives. It was of “the utmost importance,” according to Griffiths’ boss, because “This knowledge determines the rental and sale value of range lands and should also determine the size of the minimum lease or homestead for range purposes...” (W. J. Spillman, in the preface to Griffiths 1904). If fencing and leasing were to work as planned, carrying capacity had to be a coherent concept that public officials could apply, measure, and enforce. Furthermore, the capacity of any given piece of range had to be more or less static, both for administrative efficiency and so that ranchers and their financial backers could build leases into their business plans and credit instruments. Griffiths recognized these constraints, and he delivered carrying capacity estimates as best he could, as did Wooton (1916). Following Smith’s (1899) example from Texas, both were inclined to define carrying capacity by reference to forage production in poor (in other words, drought) years. In 1904, Griffiths recommended 37 acres per animal unit (AU) (or about 17 AU per section) for the Santa Rita generally, and 50 to 100 acres per AU (about 6 to 13 AU per section) for lower or more degraded ranges; in 1910 he revised the Santa Rita estimate to 32 AU per section. Wooton concurred with the latter, higher figure.

Griffiths’ reports contain numerous remarks, however, that suggest he had doubts about the concept of carrying capacity when applied “in a region where the seasons, the altitude, the slope, and the rainfall are so variable” (1904:

32). Not only did productivity vary across space and time, it was also “exceedingly difficult to decide which species are and which are not forage plants,” because, if necessary, cattle would eat almost everything (1904: 25). Even in the absence of grazing, the composition of vegetation did not display stability:

...differences in vegetation, comparing one year with another, are very striking... In the large field, even with similar rainfall, there occurs an ascendency [sic] of one plant one year and another plant another year... So far as known, no one has ever offered an explanation for these yearly variations of annual vegetation (1910: 15).

Griffiths also discerned longer term vegetation changes taking place, specifically an increase in mesquite and other shrubs, and he attributed these changes to fire suppression, not grazing. There is no evidence that his doubts diminished over time; indeed, his 1910 carrying capacity estimates were even more cautiously expressed than those of 1904. Likewise, his assertion that 3 years of complete rest would restore degraded Southwestern rangelands “approximately to their original productivity” (1910: 13) seems forced, because it conflicts with many of his other observations. He noted, for instance, that 2 consecutive years of good summer rainfall were needed for significant establishment of perennial grasses—something that occurred only once in his 10 years of research in the area.

Griffiths appears to have arrived in Arizona with few preconceptions about the desert and no scientific theories to attack or defend, allowing his curiosity wide latitude. He conducted surveys of ranchers, traveled and photographed extensively in the region, and generally let his observations lead him where they would. In these respects he stands in sharp contrast to the other major figure of this period, Frederic Clements, who arrived in Tucson in 1917 to work at the Carnegie’s Institution’s Desert Lab on Tumamoc Hill (also founded in 1903). Clements came with a heavy investment in a powerful theory—his own—and a determination to make it work in the Southwest and, indeed, everywhere.

Clements installed vegetation plots on the Santa Rita (Bowers 1990: 40), and he also drew on the work of Griffiths and other Santa Rita researchers for his 1920 book, *Plant Indicators*, which included numerous photographs from the range. The aim of the book was to demonstrate the practical uses of his famous theory—published as *Plant Succession* 4 years earlier (Clements 1916)—in managing the rangelands of the American West. The profound influence of “Clementsian” theory on range science is widely acknowledged to this day (National Research Council 1994; Society for Range Management 1995). But both *Plant Indicators* and Clements’ role in Santa Rita history have virtually disappeared from memory, as evidenced by omission from Medina’s bibliography. His practical recommendations for managing livestock in the Southwest have also been largely forgotten, even though they anticipated many future developments in semiarid range management. The debates about Clements’ role in range science and ecology have focused on the theory of plant communities and succession, but I would argue that the central practical issue was, again, carrying capacity.

Clements suffered from none of Griffiths’ doubts about the theoretical coherence of carrying capacity, but he defined it differently and was perhaps more naive than Griffiths about how it would be used in practice. Specifically, he did not

construe carrying capacities as static, and apparently he didn't see why anyone would.

No other factor produces such rapid and striking changes in carrying capacity as does rainfall. The difference in the total yield of the same range in two successive years of dissimilar rainfall may be greater than 100 per cent, and in the wet and dry phase of the same cycle it may be even greater (1920: 292).

Clements believed that some longer "cycle" existed, probably linked to sun spot activity, which might eventually render this variability tractable for science and management. But his practical recommendation was unequivocal:

It is evident that the maximum production can not have a fixed or average value... A degree of grazing which would be disastrous in a drought period would fall far short of adequate utilization during a wet one (1920: 296).

His book exhaustively classified and described Western rangelands, but he nowhere offered numerical estimates of acres per animal or animals per section.

It is imperative that the ranchman be prepared to reduce the pressure upon his range as the dry phase of the climatic cycle approaches and that he be ready to take full advantage of the excess carrying capacity of the wet phase. In fact, the whole system of improvement must be focused upon the destructive effect of overgrazing in dry years and the possibility of greater utilization and of successful sowing and planting during wet years (1920: 311).

Clements also suggested that carrying capacity was a function not just of a given range and its condition but also of management. He criticized both overstocking and stocking year around (1920: 297). Making reference to wild herbivores such as bison, he linked secondary succession to long periods of rest following heavy grazing (1920: 307), and he recommended rotation of grazing pressure to imitate this natural process (1920: 310). Like Griffiths, Thornber, and Wooton before him, Clements called strenuously for fencing:

It is immaterial whether control is secured through ownership or leasing, provided it permits fencing. However, leasing has the indirect advantage that it enables the State to exact certain conditions as to utilization (1920: 311).

Although Clements' theory of succession dominated twentieth century range science, as is well known, his practical recommendations did not dominate actual management. There is some evidence that southern Arizona ranchers practiced summer season rest and variable stocking in the 1920s (Sayre 2002), but whether they took their cues from scientists is unknown—I would guess they did not, in view of the fact that continuous yearlong grazing became the norm when ranchers shifted from stocker to cow-calf operations in the 1930s and 1940s. Even among range scientists, Clements' theory did not catch on quickly, if we may judge from the Santa Rita archive. In the minutes of the Forest Service's District 3 Grazing Studies Conference of December 1921, for example, there is no mention of the work of Clements (or Sampson), nor of succession or climax communities. With one exception (Wooton 1916), Clements' influence does not appear in Santa Rita publications until the late 1930s.

Although the number of publications from this period was small, their importance to subsequent research and range

administration was great. Griffiths and Clements were pioneers of range science both at the Santa Rita and for the nation. That both of them expressed reservations, tacitly or explicitly, about the central premise of the system of rangeland administration institutionalized over the following decades sheds new light on current debates about range ecology and management in the United States and elsewhere (Illius and O'Connor 1999).

1932 to 1945: Growth and the Shrub Problem

The second period extended from 1932 to the end of World War II, which imposed severe budget restrictions and brought publications nearly to zero by 1945. With a newly enlarged staff, the Southwestern Forest and Range Experiment Station supported more focused studies of particular forage species such as tanglehead, black grama, blue grama, and vine mesquite, as well as of noxious or invasive plants, particularly burroweed. Numerous studies sought more accurate and efficient methods of measuring vegetation and utilization—an outgrowth of the Forest Service's need to define and enforce carrying capacities. These new methods were both scientifically rigorous and practical for agencies, but they did not really address the question of static versus dynamic carry capacities on Southwestern rangelands. Revegetation remained a major focus, but with more attention on underlying ecological factors such as litter cover and soil moisture. Research on wildlife expanded as well to include kangaroo and pack rats, wood rats, quail, jackrabbits, and rattlesnakes. Finally, there was a more specialized attention to practical management issues as viewed from the perspective of private ranchers. Matt Culley (1937) produced a detailed study of the economics of one of the Santa Rita's cooperating ranches, and he and Kenneth Parker placed numerous articles in livestock journals on range and management issues such as poisonous plants, drought, and proper stocking.

Perhaps the most important study performed during this period, historically speaking, was one that was not published. "Occurrence of Shrubs on Range Areas in Southeastern Arizona" (Upson and others 1937) was a cooperative survey conducted in 1936 and 1937 by the Southwestern Forest and Range Experiment Station, the Arizona Agricultural Experiment Station, the Agricultural Adjustment Administration, and the Bureau of Agricultural Economics. It involved vegetation measurements at 450 sites coupled with ocular surveys of nearly 12 million acres, resulting in maps of the dominant vegetation covering all of southeastern Arizona (figs. 3 and 4). Nearly a third of the area was dominated by grasses, and another quarter by creosote; cactus and burroweed dominated just over 9 percent each, and mesquite dominated another 7 percent; wolfberry, saltbush, and snakeweed dominated the remaining 10 percent. The mesquite, snakeweed, and burroweed areas were singled out as having expanded in recent memory, usually at the expense of grasses, and therefore as having the greatest potential for restoration. Up to this point, burroweed had received far more attention from Santa Rita researchers than the other two species, but the survey found mesquite to be the most widespread of the three,

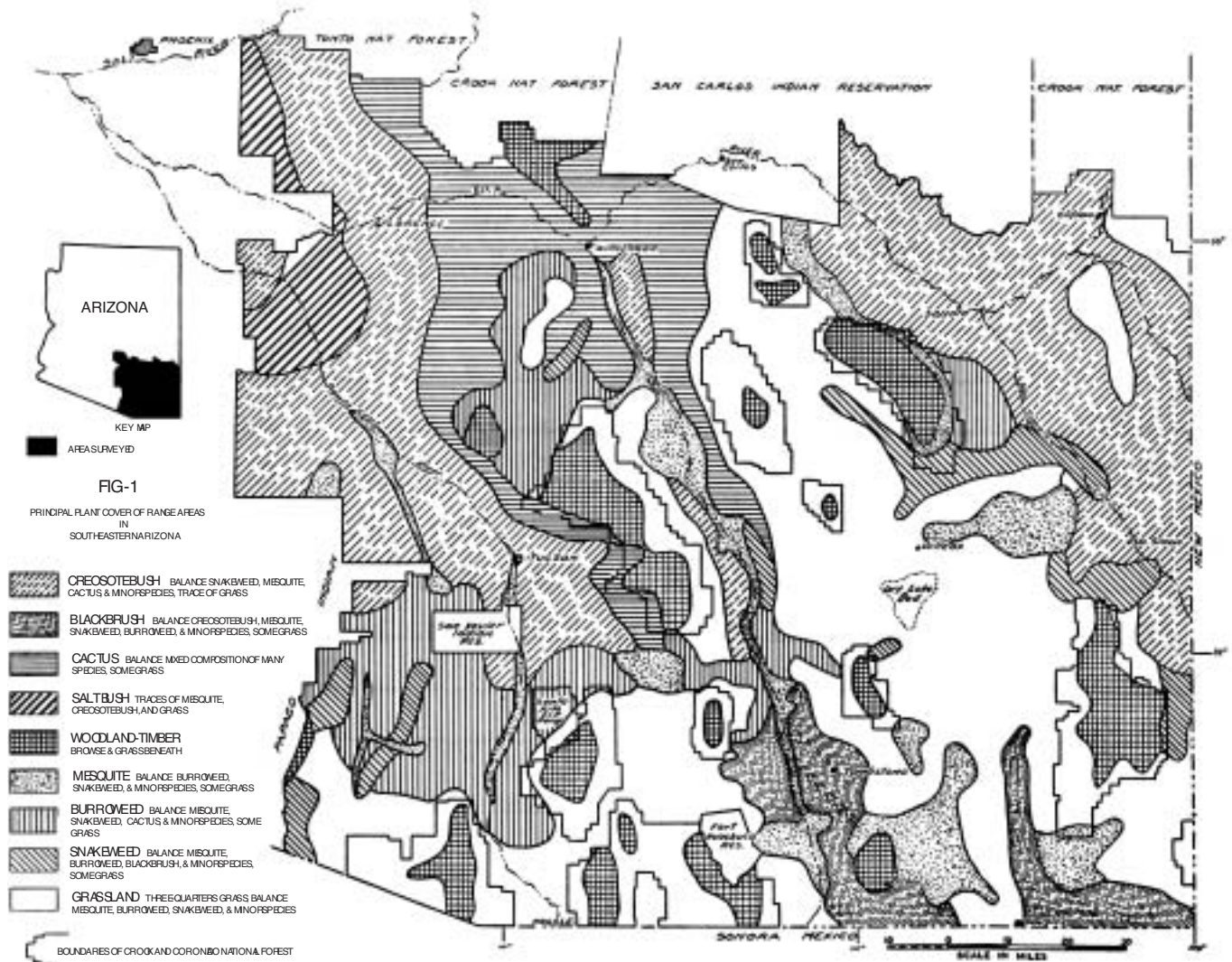

Figure 3—Map of “principal plant cover of range areas in southeastern Arizona,” 1936 to 1937. The report containing this map drew attention to shrub encroachment in areas formerly dominated by grasslands, and helped shift attention from burroweed to mesquite (Upton and others 1937).

present on more than 9 million acres—three-quarters of the region. Understanding, explaining and remedying this shift would be the dominant research priority of Santa Rita range scientists for decades to come.

As mentioned above, Griffiths had noted the spread of mesquite nearly 30 years earlier and had attributed it primarily to fire suppression, not grazing. Curiously, “Occurrence of Shrubs” did not discuss fire at all, aside from a brief mention under “Artificial Means of Control” of burroweed (p. 26). The report’s explanation of shrub expansion was that grazing—and only grazing—had shifted the competitive balance between grasses and shrubs, and that heavily grazed areas around water sources had provided sites for establishment and subsequent spread of shrubs into the surrounding range (p. 12–15). This argument was framed, moreover, in explicitly Clementsian terms: grasslands “represent, of course, the climax type” for the region, and evidence of former grass dominance in areas of shrubs was

taken to indicate that such areas “may also be considered, ecologically, a climax grassland type” (p. 12). The authors argued that reducing or eliminating grazing would retard or prevent shrub encroachment, although they also acknowledged documented cases where this had not worked, suggesting the possibility that “there are other factors than grazing which favor the spread of shrubs” (p. 24).

Researchers initiated studies of mesquite immediately following completion of the report, but they did not focus on adjusting stocking rates. Instead, techniques of killing the trees outright were tested (Parker 1943). In 1940, a study was launched in which mesquite and/or burroweed were killed on 1-acre plots; it was followed in 1945 by another, which used prisoner-of-war labor to thin mesquite to various densities on 2-acre plots. Also in 1940, the Carnegie Institution ceased its support of the Desert Lab and turned its facilities on Tumamoc Hill over to the Forest Service. The SWFRES had its headquarters there until 1953, when

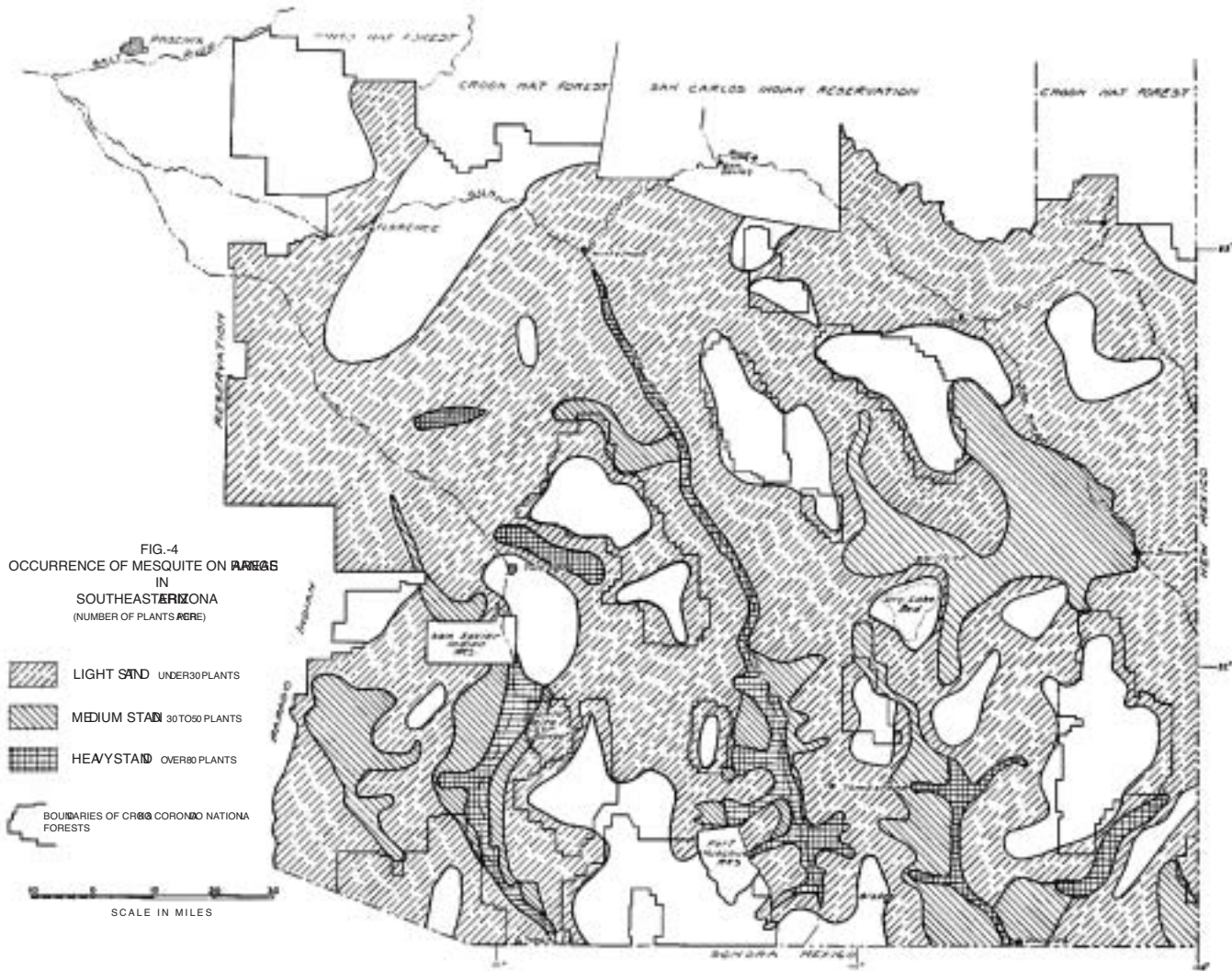

Figure 4—Map of “occurrence of mesquite on range areas in southeastern Arizona,” 1936 to 1937. The ubiquity of mesquite, present on roughly 75 percent of the region, led to intense research efforts on the Santa Rita for four decades, and especially from 1946 to 1966. At the time this map was made, however, mesquites exceeded 30 plants per acre on only 15 percent of the region; heavy stands (>80 plants per acre) were confined almost entirely to major drainages (Upson and others 1937).

it was merged into the Rocky Mountain Forest and Range Experiment Station (RMFRES), headquartered in Fort Collins, CO.

1946 to 1965: Age of Mesquite

The pace of research rebounded quickly with the end of the war, and the focus turned decisively to mesquite. The overall goal was the same as in Griffiths’ day: restoration of perennial forage grasses. But now shrubs, rather than just bare ground, stood in the way. The postwar period was a prosperous one for both ranchers and agencies, and practices previously deemed uneconomical might now pencil out. Beginning in the late 1940s, the Hope-Flannagan Research and Marketing Act made funds available for research on noxious range plants.

In 1948, with cooperative agreements up for renewal on both the Santa Rita and the Jornada Experimental Range, Kenneth Parker composed “An analysis of range problems in the Southwest,” another internal document. He cited the 1937 shrub survey in support of the claim that “mesquite constitutes a problem on some 8 million acres” in southern Arizona (p. 57)—this appears to have been an exaggeration, as the survey had found medium and high densities of mesquite on less than 2 million acres (fig. 4). Parker rejected the earlier study’s Clementsian expectation that reduced grazing would reverse the trend toward shrub domination, however. Meter-square quadrats going back to 1916 indicated no consistent relation of vegetation with either climate or grazing pressure (p. 73); herbage productivity had declined substantially, even with steadily reduced stocking rates (p. 77–79). Parker concluded that “no degree of moderation in grazing use will eliminate these

low value plants. The meaning, in unmistakable terms, is that if we are to continue grazing use by domestic livestock some positive, drastic treatment which will eliminate these plants will be necessary to achieve conservation of the grazing resource" (p. 71). Because shrub encroachment also threatened watershed function and, therefore, agricultural and municipal water supplies, Parker argued that "[t]he future welfare of the Southwest is dependent on how well and in what manner the range resource is used" (p. 7). During the severe drought of the early 1950s, a sense of emergency pervaded the ranching industry, and the "war on mesquite" played well in local newspapers (Sayre 2002).

In all but 3 years from 1947 through 1965, no less than one-third and often as many as two-thirds of Santa Rita publications focused on velvet mesquite (49 out of 109 papers altogether). Studies ranged from basic questions of life history and reproduction, to demographic analyses, to effects on soils and competition. Herbicidal approaches to mesquite control using diesel oil or chemicals were increasingly prevalent in the publications of this period. As in Griffiths' day, efforts were launched to find (or create by hybridization) a perennial grass capable of establishment on degraded semiarid rangelands, and this time several were found among South African lovegrasses, although the full implications of this success would not be evident until the late 1960s. Work on small mammals also continued, and whereas many earlier rodent studies had emphasized negative impacts on grasses, now some researchers focused on rodents' role in helping to propagate shrubs. Other wildlife research in this period included studies of javelina, cactus wren, Gambel quail, and deer.

This body of research has been of major and lasting significance to scientific understanding of semiarid grass-shrub rangelands, even though it fell short of its own goals for practical management. From a theoretical perspective, the decisive turn was from the Clementsianism of the 1937 shrub report to Parker's observation in 1948 that reducing or eliminating grazing would not by itself cause a reassertion of grasses. This opened up research questions that extended well beyond issues of livestock production, laying the foundation for subsequent investigations into water cycling and erosion, the spatial and temporal distribution of moisture and nutrients as it affects plant growth and competition (fig. 5), and the role of small mammals and invertebrates in semiarid ecosystem processes. These issues would emerge to dominate Santa Rita research in the following period. At the time, however, the concerns of range managers still focused primarily on producing livestock, and from this perspective the research fell somewhat short. The methods developed for controlling mesquite were effective only if the larger economics of ranching were very favorable—cheap diesel and high prices for calves—and only on fairly short time scales of 10 to 20 years, as mesquite steadily reclaimed treated lands. Although vast acreages would be cleared over the 30 years from 1950 to 1980, the goal of restoring native perennial grass domination once again proved elusive.

Today, we think we know the reason for this shortcoming: the near-total absence of fire from Southwestern semidesert grasslands. Fire was likewise missing from most Santa Rita research and publications of the period. In his

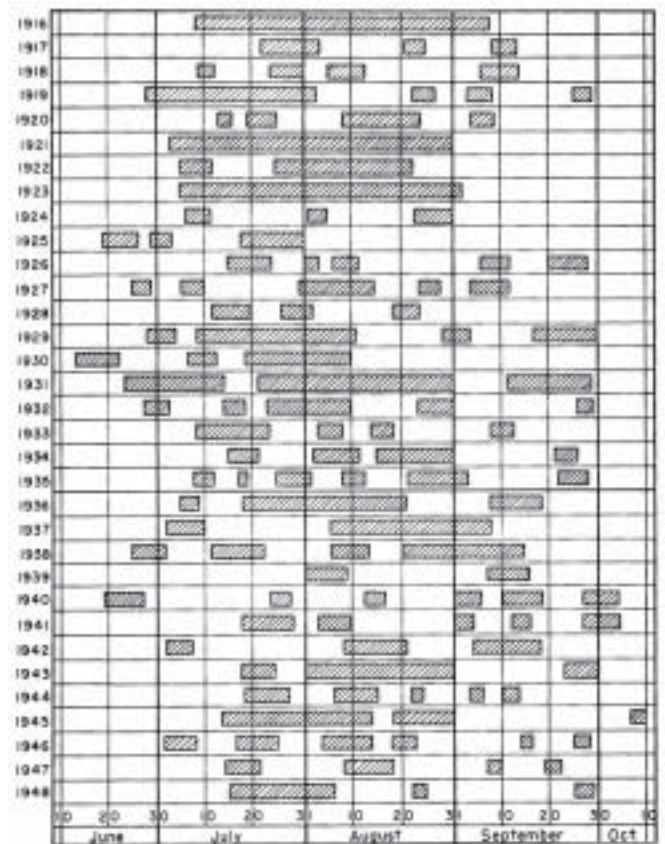

Figure 5—The temporal distribution of effective rainfall, 1916 to 1948. Shaded areas on the graph represent periods when rain fell on successive days or were preceded or followed by storms of 0.4 inch or greater during the summer growing season. The graph reflects growing understanding of the ecology of major forage plants on the Santa Rita, which were predominantly C_4 -pathway perennial grasses limited by the distribution of moisture in space and time, rather than by gross annual or seasonal rainfall (USDA 1952).

1948 internal analysis, Parker alluded to Griffiths' comments on fire suppression, but he did not elaborate on them or recommend research on the subject. Similarly, "The Santa Rita Experimental Range" booklet of 1952 (USDA 1952) devoted one-sixth of its text and numerous photos to noxious plant control, without a single mention of fire. Somewhat of a maverick, Robert Humphrey—who had originally hired on with the Desert Lab—published numerous papers making the case that fire suppression was the fundamental cause of woody plant encroachment, and that restoring fire could economically control the problem. But his argument was based more in natural history than in experimentation, and the idea did not go far, producing only two Masters theses, one technical bulletin, and two peer-reviewed publications other than Humphrey's own articles during this period. Ranchers, agencies, and the general public were all accustomed to vigorous fire suppression, and the real-world risks were obviously high. Moreover, in Parker and Martin's (1952: 14) words, "[t]he effect of fire or lack of

fire on the occurrence of mesquite stands is a moot question.” Whether from grazing, drought, shrub encroachment, or a combination of the three, much of the region’s rangelands simply didn’t have enough herbaceous fuels to carry a fire. Lehmann lovegrass had the potential to change this, however, and Humphrey stood alone on this subject, too, calling attention to the possible downsides of *Eragrostis lehmanniana* a decade before anyone else (Humphrey 1959).

The attention placed on chemical and mechanical mesquite control cast a long shadow, obscuring less exciting topics such as grazing management. Recommended practices were not much changed from earlier periods: stock conservatively, distribute grazing pressure evenly, defer or minimize grazing pressure during the summer growing season (USDA 1952). Echoing Clements, the 1952 Santa Rita booklet documented the wide variability of rainfall and forage production, and it cautioned “that the practice of building up numbers in the occasional good years removes the only chance that the range might have to improve” following drought (USDA 1952: 14). But it sought, nevertheless, to establish atemporal guidelines for stocking rates and utilization (fig. 6).

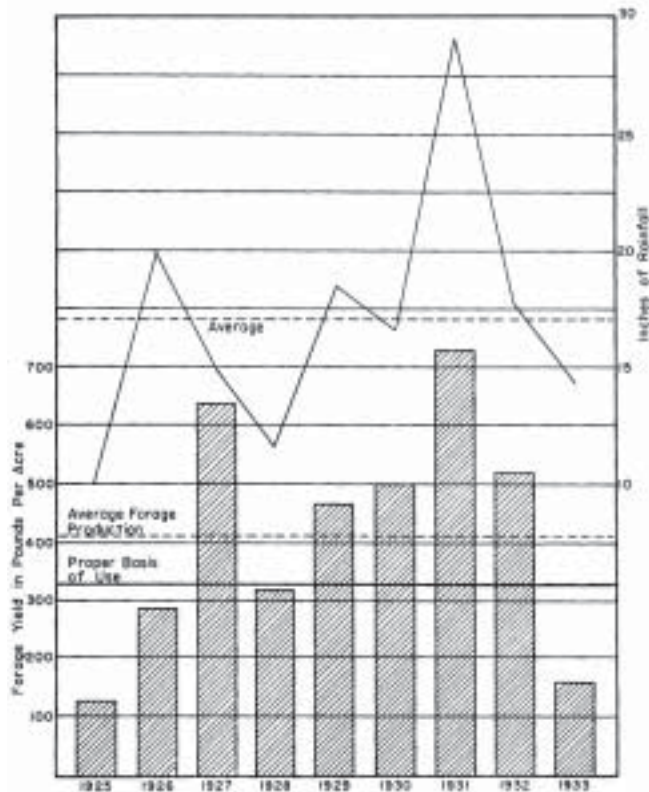

Figure 6—Graph of forage yield and rainfall on an annual basis, 1925 to 1933. Dashed horizontal lines indicate average rainfall (top) and average forage production (bottom); the solid horizontal line signifies the—“proper basis of use,” defined as roughly 20 percent below average forage production. Intended to prevent overgrazing during recurrent dry years, this guideline nevertheless perpetuated the conception of carrying capacity as a static attribute of Southwestern rangelands (USDA 1952).

Meanwhile, postwar prosperity allowed greater capitalization of many ranch operations, and mesquite control was only one of a long list of investments ranchers were making: in improved breeding, more fencing and water development, and new technologies for handling cattle (for example, holding corrals, squeeze chutes, calf tables, pickup trucks, and trailers). The “old ways of doing things on the range... were romantic, and led to a simpler and more friendly way of life,” according to the booklet. “However, they cannot compete with the modern way of doing business,” which involved replacing labor costs with fixed costs (USDA 1952: 9). By this time, cow-calf operations were the norm, and the booklet recommended dividing one’s herd into groups of 50 to 100 animals, each group with its own fenced pasture, to allow closer supervision and control of breeding. This amounted to continuous yearlong grazing, which became the norm in the region during this period.

1966 to 1988: Ecology and the Santa Rita Grazing System

Research on mesquite continued through the 1970s, but its dominance waned. The period 1966 to 1988 was the most prolific in the Santa Rita’s history, and the proportion of publications devoted to mesquite declined to only 10 percent of the total, compared to 45 percent in the previous period. A wide array of new research foci emerged, reflecting new interests and methods both in range science and in ecology more generally. In the late 1960s, animal scientists used fistulated steers to study cattle diets, nutrition, and weight gain, and the idea of frequent, automated weighing of livestock was pursued. In the early 1970s, the International Biological Program’s Desert Biome project produced a small mountain of research on soil nutrient flows, soil moisture, termites, and ants. Other research also looked below the surface of the ground to examine root systems of grasses in grazed and protected sites, competition among plants for soil moisture, variations in soil temperature, factors affecting runoff and infiltration, fungi, and the penetration and breakdown of various chemicals, especially insecticides. Wildlife research picked up considerably in the late 1970s, comprising more than a third (22 of 63) of all publications from 1976 to 1981. Different research activities fed off one another, symbiotically or parasitically depending on your perspective: mesquite removal for range restoration experiments raised the question of wildlife habitat effects; the discovery that termites consume large quantities of biomass provoked attempts to control them, just as had happened in earlier decades with rabbits and rodents.

The problem of mesquite had not gone away. Rather, confidence and funding had dissipated relative to other interests. Herbicidal methods had largely failed, and from the oil crisis of the early 1970s on, the cost of mechanical treatment could not be justified given stagnant real returns to livestock and the likelihood that retreatment would be necessary down the road. Where large-scale mesquite clearing continued, it was underwritten by real estate appreciation and other nonranching investments, and it was motivated at least partially by tax policies that incentivized losses (Sayre 2002). Meanwhile, opposition to

mesquite control, especially using chemicals, emerged among nonranchers as part of the larger social concern for the environment.

The turn to a broader ecological orientation was reflected in range science research by Clark Martin's work on grazing systems. Building on earlier Santa Rita findings about the timing of forage growth, Martin had initiated studies of various grazing/rest schedules on small plots beginning in 1957, and in the early 1970s he concluded that spring-summer rest 2 years out of 3 produced significant improvement in perennial grasses compared to continuous yearlong grazing (Martin 1973). He anticipated that these improvements would be concentrated in areas of poor range condition (Martin 1978), a prediction later confirmed in a 10-year study (Martin and Severson 1988). Perhaps the most intriguing discovery of Martin's research, and of related work by Dwight Cable (1971, 1975), was that grazing and drought had interactive, lagged effects extending over 24 to 36 months: significant improvement resulted from 2 successive years of good summer rains, and grazing could retard recovery during the first postdrought summer. These findings echoed the views of Griffiths, Clements, and the 1952 Santa Rita booklet, supporting them with hard data.

Rest-rotation grazing was not new, of course. It had antecedents in the work of Clements, among others, and the idea of deferring grazing until late in or after the growing season had been promoted in the 1910s by Jardine and Hurtt (1917) and Sampson (1914). What was new, it appears, was a commitment within the Forest Service to encourage the implementation of rotational systems on allotments throughout the Southwest. Hormay and Talbot (1961) had revived and systematized rest-rotation in the early 1960s, pointing out that under yearlong systems selective grazing would disproportionately impact palatable species, even at conservative stocking rates. Only periodic rest could prevent this, and fairly heavy grazing could be beneficial if it reduced selectivity. Hormay and Talbot even claimed that "grazing is eliminated as an environmental factor under rest-rotation grazing" (p. 40). Whether true or not, their claim completed a paradoxical evolution in range science. The discipline had long embraced Clements' theory of succession while neglecting his practical management ideas. Now it embraced one of his management ideas (without crediting him), and used it to renounce one of the central tenets associated with his theory: the primacy of grazing in determining vegetation. Cable's (1975) research indirectly supported this view by documenting the overriding importance of summer rainfall.

1988 to Present: Land Swap and Reorientation

Medina's bibliography extends only to 1988, and without knowing his methods and criteria I am reluctant to attempt to update it. The date would be an arbitrary endpoint for historical analysis, except that it was also a pivotal year in the administration and ownership of the Santa Rita Experimental Range. Funding for Santa Rita range science research had been stagnant or declining since 1975, when the Tucson-based Southwestern Station of the Rocky Mountain Forest and Range Experiment Station had been merged into

the Experiment Station at Tempe. Relative to the Southwest's booming urban and suburban economic sectors, livestock grazing had begun to appear less significant, and by the late 1980s the Santa Rita was in danger of becoming an expensive anachronism. That the title to the range still resided in the Interior Department—a fact that many people had overlooked, it seems—now became significant. It meant that the Rocky Mountain Station, and the USDA as a whole, could simply walk away from the range in response to shifting priorities and limited budgetary resources. This would leave it in the hands of the BLM, inheritor of all undisposed General Land Office holdings. But the BLM did not have resources or reason to manage an experimental range either.

Resolution came rather hastily and from an unexpected direction (Sayre 2002). Some 50 miles southwest of the range, in the Altar Valley, another branch of the Interior Department faced a difficulty. The Fish and Wildlife Service (FWS) had purchased the Buenos Aires Ranch in 1985, mainly for the purpose of restoring the endangered masked bobwhite quail. The ranch included leasehold to nearly 90,000 acres of State Trust lands, intermixed with 21,000 acres of deeded land. The FWS had removed all livestock from the new Buenos Aires National Wildlife Refuge, and it had no intention of grazing there. This meant, by policy, that the State Land Department had to reclassify the leases as commercial and charge the FWS commercial rates: 10 percent of fair market value of the land, or more than half a million dollars a year. Several small land exchanges were formulated, which would have enabled the refuge to consolidate its ownership of the prime masked bobwhite habitat. But the vast majority of the Buenos Aires lease lands would have remained subject to reclassification, or to reassignment to livestock operators.

Following a change in the governor's office in 1987, the Land Department began to press its case and the Buenos Aires lease fees started to increase, forcing regional FWS officials to scramble to cover the payments. Early in 1988, Regional Director Michael Spear and Arizona BLM Director Dean Bibbes came up with a solution, which passed into law with the Idaho-Arizona Conservation Act that November. Nearly two and a half years later, in April 1991, the transaction was executed: The Interior Department got the Buenos Aires lease lands, and the State Land Department took possession of the Santa Rita. Under a special designation passed by the Arizona legislature, the experimental range was rededicated to research and education. It was also assigned as its beneficiary the University of Arizona, which administers the range and collects lease payments directly from cooperating graziers. In this way, the Santa Rita conforms to the constitutional mandate of the State Trust to generate revenue for beneficiaries, but it is outside of the ordinary policies and procedures of the Land Department. The designation remains in place indefinitely, until and unless superseded by legislative action (Mitch McClaran, personal communication).

Under its new ownership, the Santa Rita has continued to host research projects and to work with its cooperating grazing lessees. The larger social, economic, political, and scientific context has shifted dramatically since 1903, however, and the orientation of research on the experimental range is changing to reflect new interests, opportunities,

and constraints. Issues of forage and livestock production are receding relative to those of climate change, ecological restoration, watersheds and wildlife. I will return to this reorientation in a moment, after considering the second question with which I began.

Effects on the Range

What difference did Santa Rita research make on Southwestern rangelands? The question is surprisingly difficult to answer.

Many innovations developed or recommended by Santa Rita researchers have been widely adopted: the installation of water sources every 2 to 3 miles across the range and the careful placement of mineral supplements to distribute grazing pressure evenly; the use of improved breeds and livestock handling techniques; various methods of brush control and revegetation with grasses; the construction of interior fences to control both breeding and grazing; rigorous culling of underperforming animals; and myriad variations on rotational grazing. Exactly where and when these practices have been implemented, however, and to what effect on range conditions, are difficult to determine. Grazing impacts have probably been made more homogeneous and less severe over the landscape, with differential effects depending on the scale and organism of concern. Lehmann lovegrass is established in most of the areas suited to it; whether it is choking out native grasses or otherwise causing harm is still a matter of debate, but it has unquestionably succeeded in reducing erosion compared to former conditions of shrub dominance. Many ranchers now understand the historical role of fire in these landscapes, and some are working diligently to restore it; how widely this will succeed, it is too early to tell.

One core message—avoid overgrazing—has been a constant of Santa Rita management recommendations, along with the goal of restoring perennial, warm-season grasses. Beginning early in the twentieth century, these came together in policies focused on proper stocking of National Forest allotments; later, a similar approach was applied to BLM and State lands. Clearly, proper stocking was, and remains, central to good range management. But what did it mean in practice, and what role did research play in actual stocking decisions?

It is generally known that forage production and stocking rates, as well as carrying capacity figures, have declined significantly in the past 125 years. The stocking rates recommended by Clark Martin in 1975, for example, ranged from less than 4 to 18 to 25 AU per section, depending on condition and elevation (Martin 1975: 10); these are all lower than the rates recommended by Griffiths in 1910 and Wooton in 1916, and less than half of actual rates described by Potter for the area pre-1891. Actual stocking of the Altar Valley before 1920 was three to five times greater than at present (Sayre 2000). As with the West as a whole, assessments of regional range conditions have been sporadic and hampered by inconsistent or disputed methodologies (National Research Council 1994).

Excessive grazing is usually viewed as the major cause of these declines. The agencies were expected to enforce stocking rates, but on the expansive range compliance had to be

largely voluntary, and there is evidence that overstocking was widespread in the past. Using sales data and interviews for 160 ranches that changed ownership from 1957 to 1963, Martin and Jefferies (1966) found that actual stocking of BLM and State Trust allotments was, on average, twice the official rates. Stocking decisions on State lands were largely at ranchers' discretion until the early 1980s, and it seems that every old timer has stories to tell of permittees who chronically overstocked their Federal or State allotments. For obvious reasons, however, more comprehensive data on the extent and severity of overstocking are extremely difficult to find.

Any assertion of causality between overstocking and range depletion must be qualified, however. A recent analysis of regional vegetation change argues that the drought of the 1890s might well have resulted in widespread arroyo formation even if unaccompanied by overgrazing (Turner and others 2003). Likewise, the drought of the 1950s appears to have pushed some Southwestern rangelands—with and without livestock grazing—across thresholds from which a return to climax has not occurred (Herbel and Gibbons 1996). Studies such as these suggest that grazing impacts may have been significant during periods of severe drought and much weaker, or even nil, during wetter periods. When summer rains were good, conditions could improve in the direction of the "climax" of perennial bunchgrass dominance, even under rates of stocking that we now characterize as excessive. This occurred, for example, in the upper end of the Altar Valley in the 1930s (Sayre 2002). Depletion appears to have been concentrated in drought periods, when herbaceous vegetation could decline significantly even without livestock present.

It can plausibly be argued—although not proven—that the changes in vegetation observed during the twentieth century would have occurred *even if actual stocking had adhered to official carrying capacity estimates*. Very likely, those estimates were unnecessarily restrictive during wet years and too permissive during severe droughts. In spite of the great natural variability in forage production, ranchers had obvious economic incentives to maintain their herds, even at the risk of overgrazing. "The general practice of stockmen takes no account of the great variation in yield between the dry and wet phases," complained Clements (1920: 297); this sentiment recurs in reports and bulletins throughout much of the century. Of course, actual stocking was never completely static, and carrying capacity estimates continued to be debated, studied, and revised throughout the century. But the expectation that some correct number of livestock should exist for each allotment, *independent of time*, was a misconception perfectly suited to strain relations between agencies and lessees. How could the agencies ever demand reductions below official capacities, even in severe drought, if the figures were supposed to account for poor years? Conversely, how could lessees take official capacities seriously in wet periods, when forage was many times greater than permitted numbers of animals could consume? Range scientists generated carrying capacity estimates that aspired to be independent of fluctuating rainfall, and economic and political constraints compelled ranchers and agencies to interpret proper stocking in terms of static carrying capacities—Griffiths' muted doubts and Clements' explicit admonitions notwithstanding.

In summary, the effects of Santa Rita research on regional rangelands are uncertain. Many management practices have been adopted, although we do not know how directly to attribute adoption to research findings. In some cases, such as the shift from stocker to cow-calf operations, the science may have reflected, rather than prompted, the actions of producers responding to market incentives. Santa Rita research did provide a relatively independent and objective point of reference for agencies and ranchers as they endeavored to control the number of livestock grazing on the region's Federal and State lands. This appears to have worked reasonably well provided that moisture was close to normal—although the norm may itself have been little more than a statistical artifact. Wet periods probably undermined ranchers' respect for agency guidelines (and perhaps the science behind them as well); dry periods probably undermined agencies' confidence in ranchers' judgment and intentions.

Whether observed changes in vegetation are reversible depends on whether twentieth century erosion has permanently altered the capacity of a given site to support the earlier vegetation (Turner and others 2003: 261). Where the answer is yes, overgrazing may have been responsible, and the threshold was probably crossed during a major drought. The static conception of carrying capacity—which Southwestern range scientists did not expressly denounce until the 1960s (Paulsen and Ares 1961), and which in practice remains pervasive to this day—may in turn be viewed as a contributing factor. In view of the writings of Griffiths and Clements, however, blame should fall not so much on the science produced from the Santa Rita and other experimental ranges as on the translation of research findings into policy and administration. Had Clements' dynamic notion of carrying capacity been more widely embraced, it is possible that the shortcomings of his theory would not be so obvious today: Agencies and ranchers might have adjusted stocking rates more aggressively, and the lasting damage of heavy grazing during drought might have been avoided. Then again, highly variable carrying capacities might have made Clements' theory economically and administratively impractical and precluded its adoption in the first place. Ironically, Clements himself feared that his theory might serve as "an excuse for overgrazing" (1920: 310), but whether any ranchers or agency officials rationalized heavy stocking in this way is unknown.

Conclusions

The decision to create the Santa Rita Experimental Range in 1903 rested on at least two interlocking premises. The first was that it was biogeographically representative of a large swath of Southwestern rangelands. Within its boundaries could be found conditions of vegetation, topography, soils, and climate similar to those of some 20 million acres in Arizona, New Mexico, and Texas (USDA 1952; fig. 7). The second was that it was a representative management unit, similar in size to the larger ranches that dominated the region. Both premises reflected the judgment that the highest economic use of Southwestern rangelands was grazing, such that research aimed at the needs of ranchers and range managers could benefit the entire area. A century later this

judgment no longer holds, and both premises therefore warrant reconsideration.

The highest uses of rangelands today, economically speaking, are housing development and recreation. Livestock grazing in and of itself is relatively insignificant from this perspective, although in combination with other demands—for open space, wildlife habitat, and watershed function, for example—the overall value of ranching remains high. Without getting into whether social demands on rangelands complement or compete with one another, one can safely say that the "highest and best" use is no longer uniform. Rather, it varies depending on factors such as proximity to urban areas, transportation corridors, or recreational hotspots; the distribution of wildlife species and their habitats; amenity values such as scenery and fine weather; and the threats posed by wildfire, floods, and drought to urban and exurban settlements.

The landscape is further differentiated by the history of management. Under equilibrational assumptions this was a secondary matter because the essential features of the range were fixed by soils and climate and would reassert themselves if given a chance. In theory, once scientists figured out how things worked on the experimental range, their knowledge could be taken and applied elsewhere. Now things don't look so simple, because we understand—at least in theory—that discrete events or combinations of events may have shifted conditions in different ways at different places or times. Some drainages are cut by arroyos, while others are not. In some valleys Lehmann lovegrass was planted on large areas and has spread, while in others it is limited to roadways or absent altogether. Fields cleared for crops in the early 1900s still show the effects, decades after abandonment. In some places landscape-scale fires have happened in living memory, although in most they have not. All these factors are superimposed on the natural variability of rainfall across space and time as well as the complex patterns of slope, aspect, soils, and vegetation.

There is still a near consensus that native perennial grasslands are the most desirable state for the region's semiarid rangelands, but the goals of restoration are no longer rooted in livestock production nor measurable in terms of carrying capacity. Consequently, how to achieve restoration, and at what cost, are far from clear. New goals include wildlife conservation, watershed function, open space for recreation or for scenery, and ecological restoration. Most of these generate revenues only indirectly, if at all, and they are often pursued in the absence of long-term, site-specific data. Where were various wildlife species present at what points in the past? How many livestock did each watershed support during the drought of the 1950s? Which arroyos have grown in recent decades, which have aggraded, and what factors are responsible? In summary, a map of the areas to which knowledge from the Santa Rita might be applied today would look quite different from the one shown in figure 7.

The second premise is still true, but less universally so, and its significance is different from before. Fifty-six thousand acres remains a good size for addressing practical management problems on Southwestern ranches and on ranches converted to preserves (if not ranches that have subdivided). The nature of those problems has changed in fundamental ways, however, keyed to both spatial and

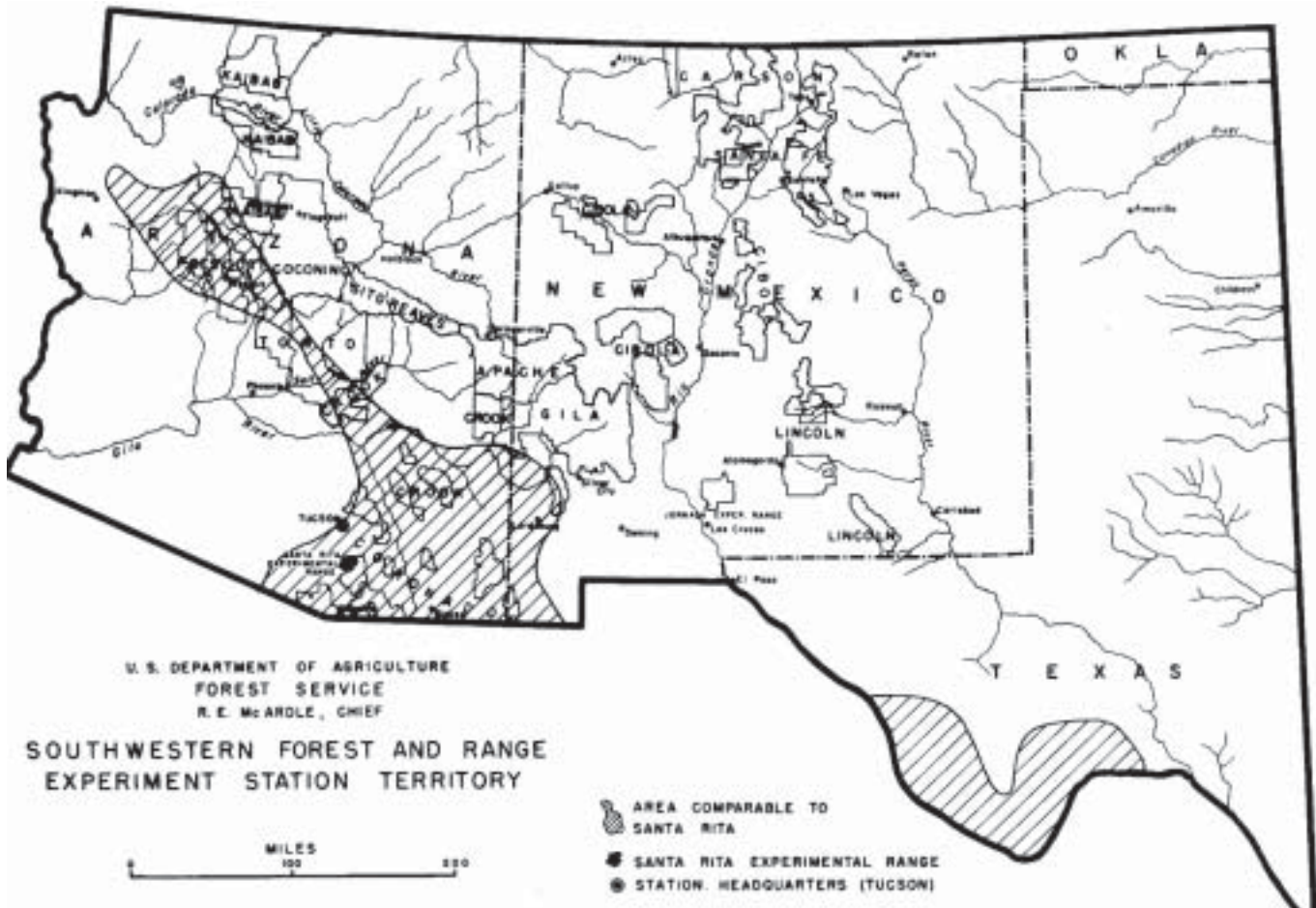

Figure 7—Map depicting the geographical areas deemed comparable to the Santa Rita Experimental Range, 1952. Although based primarily on biogeographical criteria, this judgment of the range of applicability of Santa Rita research also contained social and economic assumptions, many of which must be reconsidered in light of dramatic changes in the region's economy and demography (USDA 1952).

temporal scale. Although the Santa Rita is large, the vast majority of experiments conducted there have been relatively small (<100 acres, certainly); this reflected both practical constraints and the overriding interest in maximizing forage production and optimizing utilization. It was generally assumed that findings would extrapolate to larger areas unproblematically. More recent empirical and theoretical work casts doubt on this assumption, and today scientists aspire to landscape-scale observations and experiments.

A parallel change has occurred along the temporal axis. Most experiments have been less than 5 years in duration, but longer term data sets have had the most enduring value, even when they did not lead to publications. Perhaps the most valuable information derived from the Santa Rita in the past century, given today's needs and concerns, is the long-term series of matched photographs. The power of the photos is greater than just visual—it derives from their ability to capture change on a temporal scale unavailable to the mortal eye and impractical for more sophisticated techniques of data collection. With knowledge and concern about

climate change growing, data reaching back a century are increasingly important. That more research has not been conducted over periods of about 50 years is regrettable, but it appears that it took that long for us to recognize the need. Stewarding and sustaining the Santa Rita is essential for the continuation of past research and for crafting further long-term studies designed to answer today's questions.

Finally, it is worth reconsidering the assumption that knowledge about rangelands must originate from experiments performed in places such as the Santa Rita. In 1903, few ranchers had more than 30 years' experience managing their lands, and it made sense to aspire to teach them what could be learned by careful scientific investigation. Today, there is a significant, albeit shrinking, number of ranchers whose families carry 100 or more years' experience in one place. Their history, and their knowledge, ought now be understood as a storehouse of genuine and valuable knowledge for the second century of range science in the Southwest.

References

- Bowers, Janice E. 1990. A debt to the future: scientific achievements of the Desert Laboratory, Tumamoc Hill, Tucson, Arizona. *Desert Plants*. 10(1): 9–47.
- Cable, Dwight R. 1971. Growth and development of Arizona cotton-top (*Trichachne californica* [Benth] Chase). *Botanical Gazette*. 132(2): 119–145.
- Cable, Dwight R. 1975. Influence of precipitation on perennial grass production in the semidesert Southwest. *Ecology*. 56: 981–986.
- Chapline, William R.; Campbell, Robert S.; Price, Raymond; Stewart, George. 1944. The history of Western range research. *Agricultural History*. 18: 127–143.
- Clements, Frederic E. 1916. Plant succession: an analysis of the development of vegetation. Publ. 242. Washington, DC: Carnegie Institution of Washington.
- Clements, Frederic E. 1920. Plant indicators: the relation of plant communities to process and practice. Publ. 290. Washington, DC: Carnegie Institution of Washington.
- Culley, Matt J. 1937. An economic study of cattle business on a Southwestern semidesert range. Circ. 448. Washington, DC: U.S. Department of Agriculture. 24 p.
- Griffiths, David. 1901. Range improvement in Arizona. Bureau of Plant Industry Bull. 4. Washington, DC: U.S. Department of Agriculture. 31 p.
- Griffiths, David. 1904. Range investigations in Arizona. Bureau of Plant Industry Bull. 67 (10 plates). Washington, DC: U.S. Department of Agriculture. 62 p.
- Griffiths, David. 1907. The reseeded of depleted range and native pastures. Bureau of Plant Industry Bull. 117 (3 plates). Washington, DC: U.S. Department of Agriculture. 22 p.
- Griffiths, David. 1910. A protected stock range in Arizona. Bull. 177. Washington, DC: U.S. Department of Agriculture. 28 p.
- Herbel, Carlton H.; Gibbons, Robert P. 1996. Post-drought vegetation dynamics on arid rangelands of southern New Mexico. *Agricultural Experiment Station Bull.* 776. Las Cruces: New Mexico State University, College of Agriculture and Home Economics.
- Hormay, A. L.; Talbot, M. W. 1961. Rest-rotation grazing: a new management system for perennial bunchgrass ranges. *Production Res. Rep.* 51. Washington, DC: U.S. Department of Agriculture, Forest Service. 43 p.
- Humphrey, Robert R. 1959. Lehmann's lovegrass, pros and cons. In: *Your range—its management*. Rep. 2. Tucson: University of Arizona, Agricultural Experiment Station. 28 p.
- Illius, A. W.; O'Connor, T. G. 1999. On the relevance of nonequilibrium concepts to arid and semiarid grazing systems. *Ecological Applications*. 9(3): 798–813.
- Jardine, James T.; Hurtt, L. C. 1917. Increased cattle production on Southwestern ranges. Bull. 588. Washington, DC: U.S. Department of Agriculture.
- Martin, S. Clark. 1973. A grazing system for semidesert ranges based on responses of grasses to seasonal rest. In: *Abstracts of papers: 26th annual meeting, Society for Range Management; 1973 February; Boise, ID*. Denver, CO: Society for Range Management: 21.
- Martin, S. Clark. 1975. Ecology and management of Southwestern semidesert grass-shrub ranges: the status of our knowledge. Res. Pap. RM-156. Fort Collins, CO: U.S. Department of Agriculture, Forest Service, Rocky Mountain Forest and Range Experiment Station. 39 p.
- Martin, S. Clark. 1978. The Santa Rita grazing system. In: Hyder, Donald N., ed. *Proceedings of the First International Rangeland Congress; 1978 August 14–18; Denver, CO*. Denver, CO: Society for Range Management: 573–575.
- Martin, S. Clark; Severson, Keith E. 1988. Vegetation response to the Santa Rita grazing system. *Journal of Range Management*. 41(4): 291–295.
- Martin, William E.; Jefferies, Gene L. 1966. Relating ranch prices and grazing permit values to ranch productivity. *Journal of Farm Economics*. 48: 233–242.
- Medina, Alvin L. 1996. The Santa Rita Experimental Range: annotated bibliography (1903–1988). Gen. Tech. Rep. RM-GTR-276. Fort Collins, CO: U.S. Department of Agriculture, Forest Service, Rocky Mountain Forest and Range Experiment Station. 67 p.
- National Research Council. 1994. Rangeland health: new methods to classify, inventory, and monitor rangelands. Washington, DC: National Academy Press. 180 p.
- Parker, Kenneth W. 1943. Control of mesquite on Southwestern ranges. Leaflet 234. Washington, DC: U.S. Department of Agriculture. 8 p.
- Parker, Kenneth W. 1948. An analysis of range problems in the Southwest. Unpublished report on file in: Archives of the Santa Rita Experimental Range, University of Arizona, box SRP 60. 130 p.
- Parker, Kenneth W.; Martin, S. Clark. 1952. The mesquite problem on southern Arizona ranges. Circ. 908. Washington, DC: U.S. Department of Agriculture. 70 p.
- Paulsen, Harold A., Jr.; Ares, Fred N. 1961. Trends in carrying capacity and vegetation on an arid Southwestern range. *Journal of Range Management*. 14(2): 78–83.
- Potter, Alfred F. 1902. Report of the examination of the proposed Santa Rita Forest Reserve. Unpublished report on file in: Archives of the Santa Rita Experimental Range, University of Arizona, box SRP 67. 27 p.
- Sampson, Arthur W. 1914. Natural revegetation of range lands based upon growth requirements and life history of the vegetation. *Journal of Agricultural Research*. 3(2): 93–147.
- Sayre, Nathan F. 2000. Land use history of the Altar Valley. Task 3 of the Altar Valley watershed resource assessment. Tucson, AZ: Altar Valley Conservation Alliance.
- Sayre, Nathan F. 2002. *Ranching, endangered species, and urbanization in the Southwest: species of capital*. Tucson: University of Arizona Press.
- Smith, Jared G. 1899. Grazing problems in the Southwest and how to meet them. *Division of Agrostology Bull.* 16. Washington, DC: U.S. Department of Agriculture. 47 p.
- Society for Range Management. 1995. New concepts for assessment of rangeland condition. *Journal of Range Management*. 48(3): 271–282.
- Thornber, J. J. 1910. The grazing ranges of Arizona. Bull. 65. Tucson: University of Arizona, Agricultural Experiment Station. 360 p.
- Toumey, J. W. 1891. Arizona range grasses in general; overstocking the range. *Arizona Agricultural Experiment Station Bull.* 2. Tucson: Arizona Agricultural Experiment Station.
- Turner, Raymond M.; Webb, Robert H.; Bowers, Janice E.; Hastings, James Rodney. 2003. *The changing mile revisited*. Tucson: University of Arizona Press.
- Upton, Arthur; Cribbs, W. J.; Stanley, E. B. 1937. Occurrence of shrubs on range areas in southeastern Arizona. Unpublished report issued by the Arizona Agricultural Experiment Station. On file in: Archives of the Santa Rita Experimental Range, University of Arizona, box SRP 60. 30 p.
- U.S. Department of Agriculture. 1952. *The Santa Rita Experimental Range. Booklet (revised)*. Tucson, AZ: U.S. Department of Agriculture, Forest Service, Southwestern Forest and Range Experiment Station. 17 p.
- Webb, George E. 2002. *Science in the American Southwest*. Tucson: University of Arizona Press.
- Wooten, E. O. 1916. Carrying capacity of grazing ranges in southern Arizona. Bull. 367. Washington, DC: U.S. Department of Agriculture. 40 p.

A Century of Vegetation Change on the Santa Rita Experimental Range

Abstract: We know more about vegetation change on the Santa Rita Experimental Range since 1903 than is known about any other 20,000-ha area in the world. This record is only possible because important techniques of measuring vegetation changes were developed on the Santa Rita, such as repeat photography and the line intercept transect method, and because they were applied often and broadly. A 100-year record of experiments and systematic observations nourishes the interpretation of these changes. Together, they describe a steady increase of mesquite trees, four cycles of burroweed eruption and decline, one cholla cactus cycle, interannual and interdecadal variation in native grass composition, and the recent dominance of the nonnative Lehmann lovegrass. The most conspicuous change is the increase of mesquite, which began before 1903 when the spread of seed by livestock and cessation of fire led to the establishment of mesquite in the open grasslands. The growth of these plants and subsequent recruits transformed the grasslands into a mesquite-grass savanna, and neither the elimination of livestock grazing nor the occasional fire has reversed this change. Burroweed cycles appear to be more closely related to winter precipitation patterns and maximum plant longevity than land management activities. Similarly, the increase of Lehmann lovegrass is largely independent of livestock grazing management.

Keywords: mesquite, burroweed, cacti, perennial grasses, Lehmann lovegrass, cover, density, repeat photography

Acknowledgments: Steve Archer, James Bartolome, Susan Jorstad, and Chad McMurtry provided excellent comments on an earlier version of this paper. Dawn Browning assisted with figure 1. This effort is dedicated to all the scientists who contributed to the 100-year legacy of knowledge generated on the Santa Rita, and especially Dwight Cable and S. Clark Martin for their extensive and systematic measurements of vegetation. The Santa Rita Experimental Range digital database at <http://ag.arizona.edu/SRER> provided some of the data sets used in this paper. The U.S. Department of Agriculture, Forest Service, Rocky Mountain Research Station, and the University of Arizona provided funding for the digitization of these data.

Introduction

A century of detailed observation, repeat photography, and systematic remeasurement provide an unparalleled opportunity to reckon the past, evaluate the present, and predict the future vegetation changes on the Santa Rita Experimental Range. The long and rich history of experiments and manipulations provide valuable information for interpreting these changes. This legacy reveals that future vegetation changes will likely be contingent on the elevation and soils, future precipitation patterns, and the current condition of the vegetation.

In general, the century of vegetation change on the Santa Rita included (1) an increase in mesquite trees; (2) several cycles of burroweed and cholla cactus that persisted for several decades; (3) an initial increase in native perennial grasses following livestock removal in 1903 and subsequent seasonal and annual fluctuations; and (4) increased dominance of the nonnative Lehmann lovegrass since 1975 and the coincident decline of native grasses. However, these dynamics have not been uniformly expressed in space or time. In some cases these inconsistencies are clearly associated with unique geomorphic features such as washes and soil differences or distinct precipitation patterns, but other inconsistencies are not as easily explained.

Mitchel P. McClaran is Professor of Range Management, School of Renewable Natural Resources, 325 Biological Sciences East, University of Arizona, Tucson, AZ 85721; telephone (520) 621-1673; e-mail: mcclaran@u.arizona.edu

In: McClaran, Mitchel P.; Ffolliott, Peter F.; Edminster, Carleton B., tech. coords. Santa Rita Experimental Range: 100 years (1903 to 2003) of accomplishments and contributions; conference proceedings; 2003 October 30–November 1; Tucson, AZ. Proc. RMRS-P-30. Ogden, UT: U.S. Department of Agriculture, Forest Service, Rocky Mountain Research Station.

This paper describes the patterns of vegetation change on the Santa Rita since 1903 and reviews the research attempting to interpret the mechanisms contributing to these patterns. The information is confined to work performed on the Santa Rita in order to celebrate the richness of that legacy. The physical setting and administrative history are described first, followed by a review of the methods used to measure vegetation that were developed on the Santa Rita. The patterns and interpretations of changes in mesquite, burroweed, cactus, and perennial grasses are then reviewed. The concluding section begins by stressing that we are obliged to continue remeasuring and rephotographing these areas in order to continue this legacy. A brief description of interpretative research opportunities follows. Finally, suggestions are made for applying these data to evaluate theoretical issues of vegetation change and for developing practical management tools that are based on a large empirical body of work.

The Santa Rita

Located about 80 km south of Tucson, AZ, the 21,000-ha Santa Rita Experimental Range stretches across the western alluvial skirt of the Santa Rita Mountains. Elevation increases from about 900 to 1,400 m, and average annual precipitation increases along this gradient from 275 to 450 mm (fig. 1). Between 1,100- and 1,200-m elevation, the mean (1922 to 2003) summer and winter precipitation have been 213 and 158 mm since 1922 (fig. 2). There is striking evidence of significant interannual (CV winter = 44.7 percent and CV summer = 31.4 percent) and interdecadal variation in precipitation at these elevations, and similar

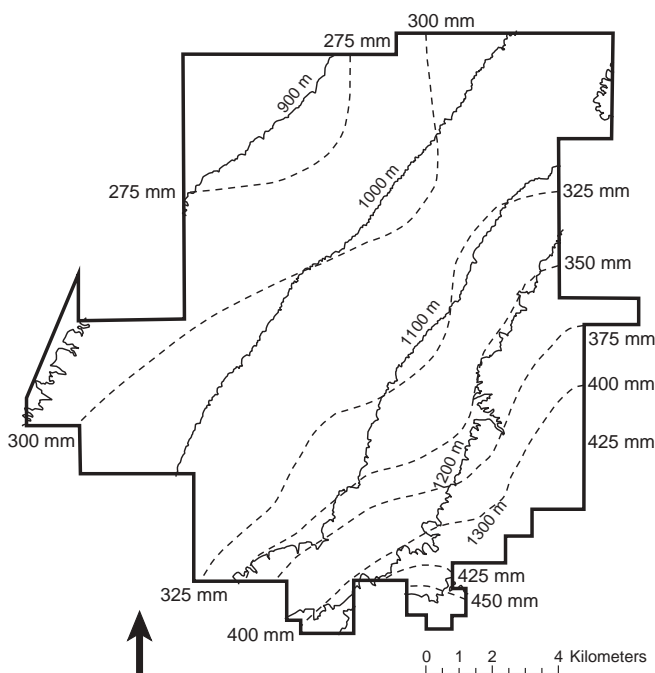

Figure 1—Elevation and annual precipitation gradients on the Santa Rita Experimental Range.

patterns occur at other elevations. Noteworthy features of the precipitation record are distinct summer and winter patterns; very wet summers in 1931 and 1984; a prolonged dry period from 1932 to the late 1950s; wet conditions in the mid 1980s; and since 1988 to 1989, high interannual variability (CV winter = 51.0 percent and CV summer = 37.6 percent).

The current vegetation is a mixture of short trees, shrubs, cacti and other succulents, perennial grasses, and other herbaceous species (table 1). The physiognomy ranges from a desert scrub at the lowest elevations to savanna woodlands at the highest. The most extensive vegetation is a mesquite-grass savanna, but Desert Grassland has become a popular moniker (McClaran 1995).

Established in 1903, the Santa Rita is the oldest continuously operating rangeland research facility in the United States (McClaran and others 2002). Until 1988, it was operated by the U.S. Department of Agriculture, first by the Bureau of Plant Industry (1903 to 1915) and later by the Forest Service (1915 to 1988). It was then transferred to the Arizona State Land Department (Medina 1996). The 38th Arizona Legislature (1987) dedicated the area for rangeland research and education, and assigned administration to the University of Arizona, College of Agriculture and Life Sciences (Arizona Senate Bill 1249).

Beginning around 1880, overgrazing of vegetation and livestock dieoff were widespread because severe droughts were common and open access to rangeland prevented control of livestock numbers (Bahre and Shelton 1996; Griffiths 1904). Fires were probably frequent prior to the intensification of livestock grazing (Humphrey 1958), and based on the survival rates of different sized plants, the average time between fires appears to have been 5 to 10 years. Since 1903, fire has been very rare. However, three arson-caused fires in June 1994 covered about 10,000 ha.

Between 1903 and 1915, livestock were excluded from all areas below about 1,200-m elevation to allow the vegetation to recover from overgrazing and to ascertain its productive potential. Since reinstatement of grazing in 1915, hundreds of experiments and manipulations have been performed to evaluate livestock grazing practices, rodent influences, methods of vegetation control, and seeding of plants (Medina 1996). A portion of this original data is available in digital form (McClaran and others 2002), but most of it resides in the paper archive at the College of Agriculture and Life Sciences, University of Arizona.

A Legacy of Documenting Vegetation Dynamics

Our well-founded understanding of vegetation change during this century is only possible because of the long record of observations, photographs, and systematic remeasurement. No other research facility has a longer and more detailed record of vegetation change. The duration and detail of vegetation change documentation at the Santa Rita is unrivaled thanks to the foresight, innovation, and initiative of early scientists. Records of their measurements and observations have been published or otherwise preserved, and there are many cases where succeeding scientists have continued these measurements. Although initial vegetation

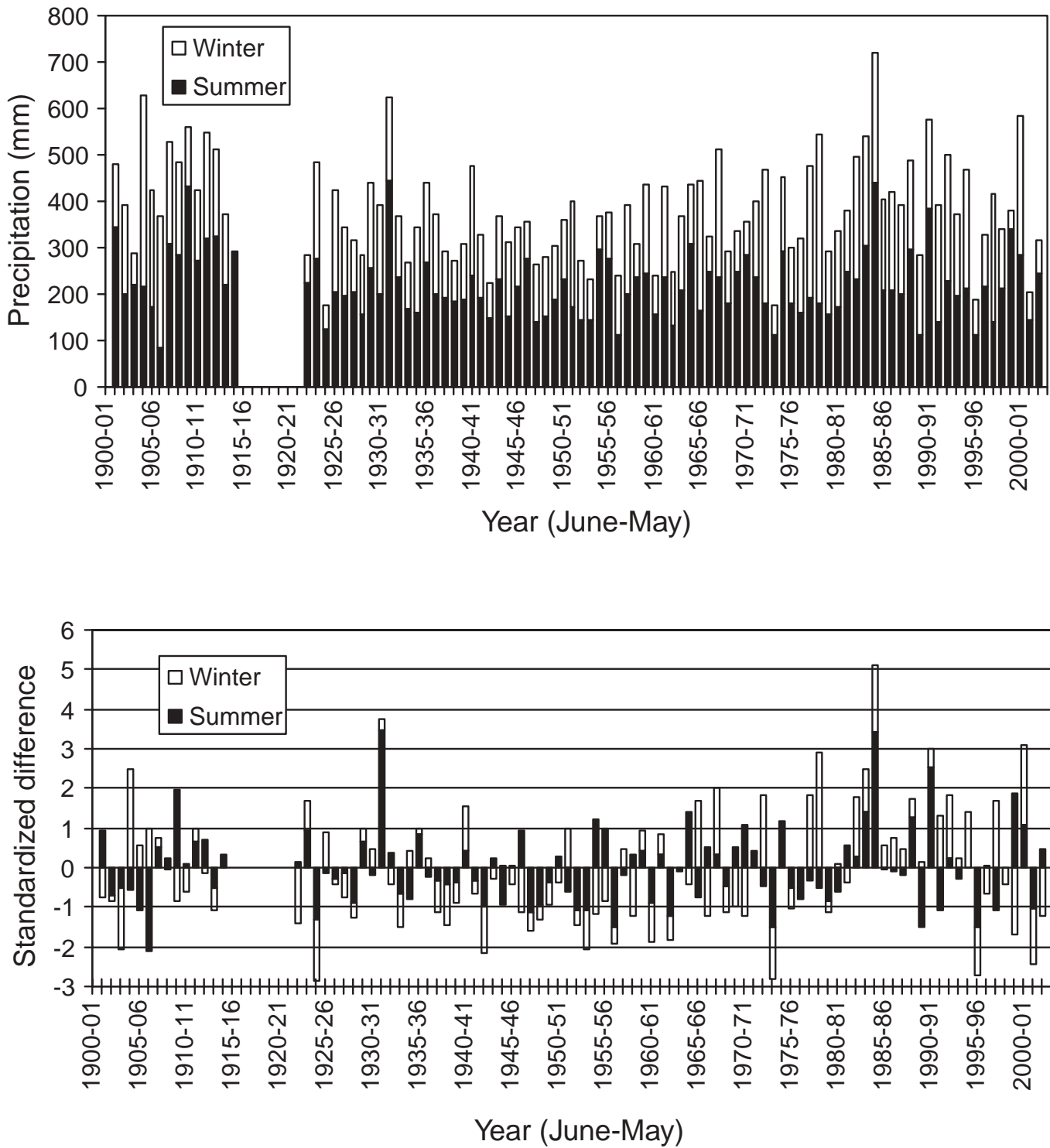

Figure 2—Seasonal and standardized difference for precipitation on the Santa Rita Experimental Range, 1901–1902 to 2002–2003. Values are from 1902–1903 to 1913–1914 for McClary Ranch, 1,200-m elevation (Thornber 1910; Wooten 1916); values since 1922 are the average of four rain gauges, Box, Eriopoda, Road, and Rodent between 1,100- and 1,200-m elevation (McClaran and others 2002). Summer months are June through September. Standardized difference is the yearly value minus the long-term average, which is divided by the standard deviation. Mean and standard deviation for McClary Ranch were calculated separately from other rain gauges.

Table 1—Common and scientific names for common shrubs and trees, cacti and succulents, and grass species on the Santa Rita Experimental Range.

Common name	Scientific name
Shrubs and trees	
Blue palo verde	<i>Cercidium floridum</i> Benth.
Burroweed	<i>Isocoma tenuisecta</i> Greene
Catclaw acacia	<i>Acacia greggii</i> Gray
Creosote bush	<i>Larrea tridentata</i> (Sesse & Moc.) Cov.
Desert hackberry	<i>Celtis pallida</i> Torr.
Velvet mesquite	<i>Prosopis velutina</i> (Woot.)
Cacti and succulents	
Cane cholla	<i>Opuntia spinisior</i> (Engelm.) Toumey
Chainfruit cholla	<i>Opuntia fulgida</i> Engelm.
Fishhook barrel	<i>Ferocactus wislizenii</i> (Engelm.) Britt. & Rose
Prickly pear	<i>Opuntia engelmanni</i> Salm-Dyck
Saguaro	<i>Carnegiea gigantea</i> (Engelm.) Britt. & Rose
Soaptree yucca	<i>Yucca elata</i> Engelm.
Grasses	
Black grama	<i>Bouteloua eriopoda</i> (Torr.) Torr.
Bush muhly	<i>Muhlenbergia porteri</i> Scribn.
Cottontop	<i>Digitaria californica</i> (Benth.) Henrard
Curly mesquite	<i>Hilaria belangeri</i> (Steud.) Nash
Fluff grass	<i>Erioneuron pulchellum</i> (Kunth) Tateoka
Hairy grama	<i>Bouteloua hirsuta</i> Lag.
Lehmann lovegrass	<i>Eragrostis lehmanniana</i> (Nees)
Needle grama	<i>Bouteloua barbata</i> Lag.
Pappus grass	<i>Pappophorum macronulatum</i> Nes
Rothrock grama	<i>Bouteloua rothrockii</i> (Vasey)
Santa Rita threeawn	<i>Aristida glabrata</i> (Vasey) Hitchc.
Sideoats grama	<i>Bouteloua curtipendula</i> (Michx.) Torr.
Six weeks grama	<i>Bouteloua aristidoides</i> (Kunth) Griseb.
Slender grama	<i>Bouteloua filiformis</i> (E. Fourn.) Griffiths
Spidergrass	<i>Aristida ternipes</i> Cav.
Sprucetop grama	<i>Bouteloua chondrosoides</i> (Kunth) Benth.
Tall threeawn	<i>Aristida hamulosa</i> Henr.
Tanglehead	<i>Heteropogon contortus</i> (L.) P. Beauv.

descriptions were largely based on qualitative observations, some important systematic and quantitative measures were developed and repeatedly applied on the Santa Rita beginning in 1902.

The qualitative descriptions of the Santa Rita and nearby areas by Griffiths (1904, 1910), Thornber (1910), and Wooten (1916) are among the first systematic, professional accounts of vegetation composition and conditions in the North American arid Southwest. They provide the baseline from which to judge all subsequent vegetation changes. For example, based on Griffiths' initial descriptions (1904), Wooten (1916) was able to make the first estimates of rates of recovery for arid grasslands following exclusion of livestock grazing.

Between 1903 and 1908, Griffiths (1904, 1910) performed the first systematic and repeated measures of herbaceous biomass production in arid grasslands by clipping, drying and weighing plants in twenty-eight 0.9 by 2.1 m (3 by 7 ft) plots in the same locations. Wooten (1916) repeated those measurements between 1912 and 1914.

Griffiths's (1904, 1910) photographs in 1902 and 1903 provided the basis for the first use of repeat photography to document vegetation change in arid grasslands when Wooten (1916) used repeat photography to assess changes in burroweed abundance between 1903 and 1913. These efforts fostered the continuation of repeat photography on the Santa Rita that includes the first use to document changes in mesquite abundance (Parker and Martin 1952) and growth rates of chainfruit cholla (Tschirley and Wagley 1964). The repeat photography collection (McClaran and others 2002) is one of the largest and most accessible in the world.

Systematic and repeated mapping of individual grass plant basal area was performed on hundreds of permanent 1-m² quadrats on the Santa Rita from the late 1910s into the 1930s (Canfield 1957; Hill 1920). Although scientists at the Santa Rita developed modifications to improve the efficiency and accuracy of mapping (for example, the pantograph [Hill 1920] and the densimeter [Culley 1938]), the method was abandoned because it was too time consuming, and it did not measure the trees, shrubs, and cacti. The measurement of those nongrass species gained urgency when their abundance began to increase in the 1930s.

The line intercept transect method used to measure plant cover was developed by Canfield (1942) while working on the Santa Rita. It replaced the quadrat mapping method because it was more efficient and measured both grass and nongrass plant cover. This continues to be one of the most widely used methods of estimating plant cover in the world. Martin and Cable (1974) and Cable and Martin (1975) measured cover from 1957 to 1966 on about 200 permanent transects. By adding a width dimension to the line transect, Martin and Severson (1988) combined the measures of plant cover and density at 150 permanent located transects every 3 years from 1972 to 1984. My colleagues and I have completed the remeasurement of about 130 of those transects every 3 years between 1991 and 2003 (McClaran and others 2002). About half of those transects have a measurement history that started in 1957. This 46-year record of repeated measurement provides a unique opportunity to document long-term changes of individual species and vegetation.

Double-sampling methods of estimating herbaceous production were conducted adjacent to the permanent line intercept transects beginning in the 1950s (Cable and Martin 1975; Martin and Cable 1974). Unfortunately, the comprehensive measurement of herbaceous production was last performed on the Santa Rita in 1984 (Martin and Severson 1988).

Changes in Mesquite Abundance

Mesquite is a long-lived (greater than 200 years), leguminous tree that can grow greater than 5 m tall. The roots are both shallow and deep (0.25 to greater than 3.0 m), and some shallow roots may extend far (15 m) from the trunk (Cable 1977). Growth begins in April after a winter deciduous period (Cable 1977). Seeds can remain viable for 20 years in the soil (Martin 1970), and plants as small as 1-cm basal diameter will generally resprout from basal meristems after aboveground mass is removed (Glendening and Paulsen 1955).

Pattern

Based on observations and photographs between 1902 and 1915, mesquite trees and other woody plants such as catclaw acacia, blue palo verde, and creosote bush were most common below 1,000 m and confined to the larger washes and arroyos above that elevation (figs. 3 and 4; Griffiths 1904, 1910; Thornber 1910; Wooten 1916). However, as

early as 1902, small mesquite plants (less than 1 m tall) were scattered in the grassland areas between the washes above 1,000 m, and their increase by 1915 was noted by these observers.

Since 1930, the increase of mesquite density and cover was greatest between 1,000 and 1,150 m, the same elevations where the incipient trees mentioned earlier had been noted. Between 1934 and 1954, there was a 33-percent increase in

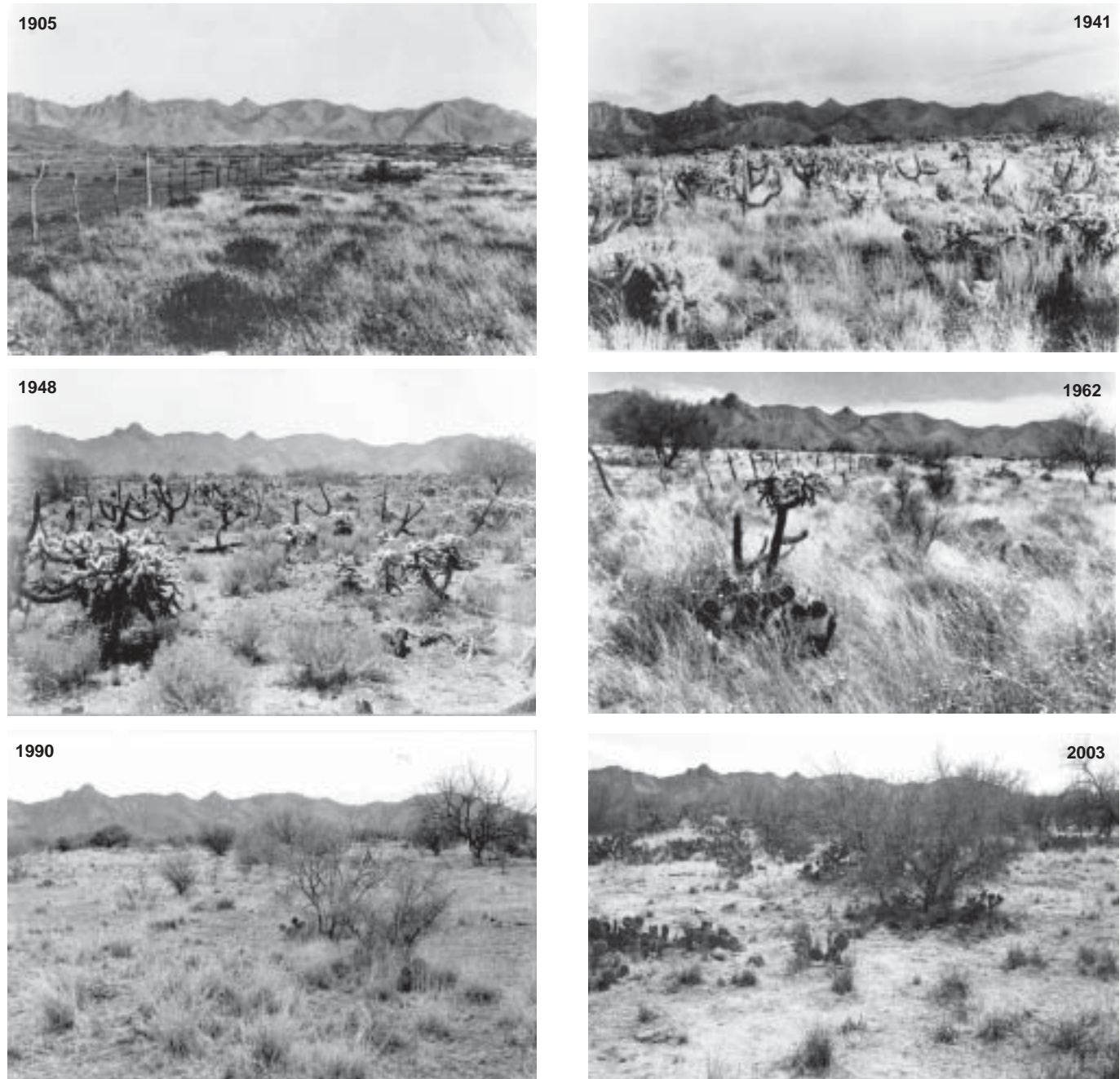

Figure 3—Repeat photography (1905 to 2003) looking east from Photo Station 231, on deep, sandy loam soil, at 1,080-m elevation (McClaran and others 2002). April 1905 shows Santa Rita boundary and ungrazed condition of vegetation, and the dark patches are probably poppy flowers in bloom. From September 1941 to June 1948 and March 1962 shows duration of cholla eruption, and seasonal variation in grass biomass. March 1990 to March 2003 shows increased size of blue palo verde, mesquite, and prickly pear cactus. The nonnative Lehmann lovegrass is not present.

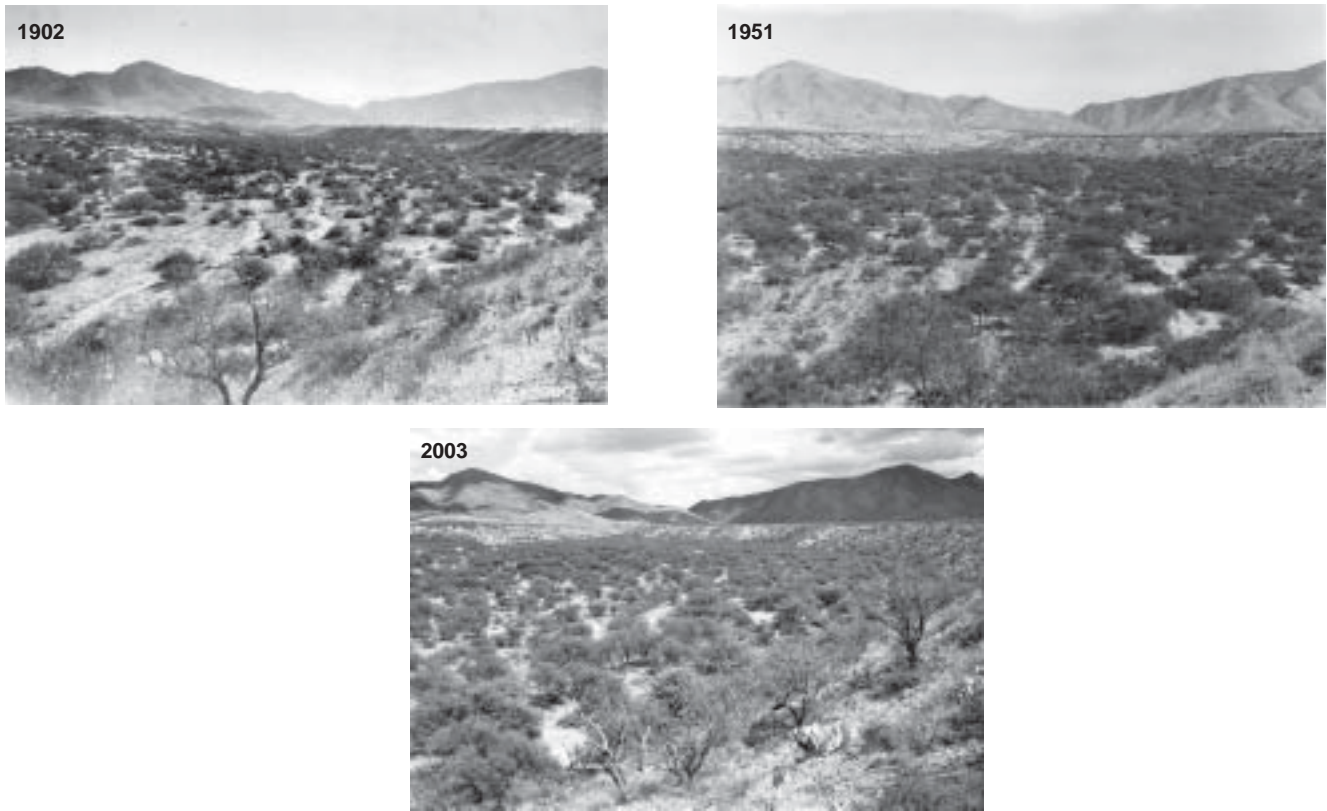

Figure 4—Repeat photography (1902 to 2003) looking east from Photo Station 222 into Box Canyon arroyo, at 1,150-m elevation (McClaran and others 2002). In 1902 mesquite are abundant in the arroyo, and a few trees are scattered on the flat grasslands above the drainage. Since 1902, there are slightly more trees in the arroyo but many new trees in the grasslands, and they appear as a dark, horizontal line above drainage.

the areal extent of the Santa Rita where mesquite density exceeded 198 plants per ha, and the occurrence of those densities spread from lower elevations to above 1,050 m (Humphrey and Mehrhoff 1958; Mehrhoff 1955). Since 1972, this density class has become the norm. Between 1972 and 1984, the average density remained about 300 plants per ha at 900 to 1,350 m elevations (Martin and Severson 1988). Over a longer time period (1972 to 2000) and slightly lower

elevation (900 to 1,250 m), density fluctuated between 200 and 450 trees per ha (fig. 5).

Mesquite canopy cover also increased after 1930, but it has not reached the maximum of 30 percent that Glendening (1952) predicted from stand-level expansion rates between 1932 and 1949. In the early 1940s, Canfield (1948) roughly estimated mesquite cover to be 4 to 8 percent throughout the Santa Rita using simple visual observations. At elevations

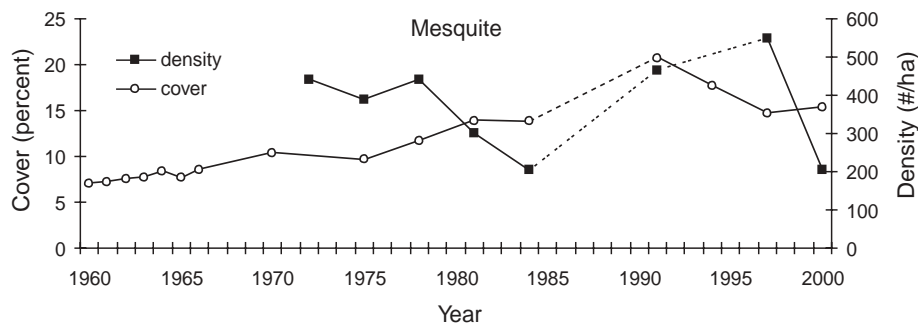

Figure 5—Change in mesquite cover and density on 74 permanent transects between 950- and 1,250-m elevation (McClaran and others 2002). No mesquite or burweed removal treatments were applied to these transects. Dashed lines indicate periods of greater than 5 years between remeasurements.

between 900 and 1,250 m, mesquite cover has increased according to systematic remeasurements of permanent line intercept transects: from 1957 to 1966, Martin and Cable (1974) estimated cover at 9.5 percent, and from 1960 to 2000, cover increased from 7 percent to a peak of 20 percent in 1991, but declined to 15 percent by 2000 (fig. 5).

Repeat photography illustrates this increase of mesquite in the grasslands (figs. 3 and 6), where increases in density have generally slowed since the 1970s, but tree cover has generally increased with the growth of individual trees. The exceptions are the washes and arroyos (for example, fig. 4) where trees were already abundant in 1902, and in areas with rocky, clay-rich soils where mesquite remains largely absent (fig. 7).

Interpretations

Numerous scientists performed experiments and controlled observations to interpret how livestock grazing, rodents, fire, and perennial grasses may have influenced mesquite dynamics.

From the early 1930s to late 1940s, the exclusion of rodents and/or cattle did not stop the increase of mesquite at elevations between 1,050 and 1,100 m. Mesquite increased from about 140 to 380 plants per ha between 1932 and 1949 (Glendening 1952) and from about 280 to 380 plants per ha (Brown 1950) across all exclusion treatments. A similar pattern emerged when yearlong and seasonally grazed pastures were compared from 1972 to 1984: the average 300 plants per ha did not differ between treatments (Martin and Severson 1988).

The likely role of cattle and rodents in dispersing mesquite seed, and the optimum burial depth by rodents for germination were revealed in the mid-1950s. Some seeds remain viable after cattle digestion, but estimates of viability vary from 58 to 73 percent (Glendening and Paulsen 1955) to only 3 percent (Cox and others 1993). Reynolds (1954) reported that kangaroo rats buried mesquite seed 1 to 3 cm, a depth optimal for germination, but they later consumed 98 percent of these seeds. He also estimated that they dispersed seeds a maximum of 32 m. Based on this, he suggested that if kangaroo rats were the sole vector of dispersal, mesquite would spread 1.6 km in 500 years, assuming a 20-year period before the newly established mesquite would produce seed.

By 1950, it was apparent that even small (1-cm basal diameter) mesquite were able to sprout from basal meristems after the aboveground portions of the plant were killed by a fire. Glendening and Paulsen (1955) and Cable (1965) reported only 11 to 60 percent mortality for 1 cm basal diameter plants, and that rate decreased to about 5 percent for plants greater than 15 cm diameter. Survival was much less likely for younger and smaller (less than 1 cm basal diameter): only one-third of 1-year mesquite survived to resprout after a fire (Cable 1961). Womack (2000) confirmed results that plants greater than 15 cm basal diameter have less than 5-percent mortality, and he noted that mortality declined as size and number of basal stems (trunks) increased. Not surprisingly, by 1965 there were no differences in the density of mesquite on unburned areas, areas burned once (1952), and areas burned twice (1952 and 1955) (Cable 1967). Similarly, 3 years after a 1975 fire, mesquite cover did not differ between burned and unburned areas (Martin 1983).

Glendening and Paulsen (1955) reported that mesquite seed germination and establishment were 16 times greater in the absence of grass than when seeds were sown within dense stands of cottontop, black grama, and bush muhly. However, they acknowledged that while grass may interfere with mesquite establishment, bare patches between grass plants were ubiquitous even in areas ungrazed by cattle.

Focusing on the seed and seedling stages of mesquite life history is helpful in understanding how the increase of mesquite has not been influenced by the manipulations of livestock, rodents, and fire. The establishment of mesquite plants in the grasslands started with the livestock dispersing undigested seeds that were produced by plants growing in the arroyos. Some of the seed in the cattle dung may have germinated and established. Kangaroo rats may have collected other seeds from the dung and buried them at optimum depths for germination. This series of events would account for the abundance of scattered small mesquite in the grasslands by 1902. The cattle vector provided the long distance dispersal that was not possible by kangaroo rats alone. By 1930, when small mesquite and caches of mesquite seed were present, the removal of rodents and/or livestock did not limit their continued recruitment or growth.

The general absence of fires between the 1880s and 1903 followed after heavy livestock grazing had reduced the mass and continuity of the grass fuel source. Consequently, the scattered, recently established seedlings in the open grasslands did not experience fires when they were most susceptible to damage (less than 5 years and less than 1 cm diameter). Griffiths (1910) and Wooten (1916) applied this scenario to interpret the increase of small mesquites in the grassy plains of the Santa Rita observed between 1903 and 1915. Although they were unfamiliar with the details of seed germination and dispersal, and seedling response to fire, they recognized that these early life history stages were key to the understanding the incipient transformation of treeless grasslands into mesquite savannas.

Changes in Burroweed Abundance

Burroweed is a short-lived (less than 40 years) shrub that can grow up to 1.3 m tall (Humphrey 1937). Roots are common at depths greater than 1 m deep but are relatively scarce at shallower (5- to 30-cm) depths (Cable 1969). The greatest period of growth occurs in spring, but some expansion of the canopy occurs in summer (Cable 1969). Seeds germinate in winter and spring (Humphrey 1937). They are toxic and not commonly eaten by livestock (Tschirley and Martin 1961).

Pattern

Four cycles of burroweed increase and decline have been reported since 1903. Their duration was about 15 to 20 years, but they have not been perfectly synchronous across the Santa Rita. Changes in abundance were a function of changes in both density (recruitment and death of plants) and cover (growth and shrinkage of plants).

The first reported cycle ended in 1914 (Wooten 1916). The beginning is harder to determine, but Griffiths (1904, 1910)

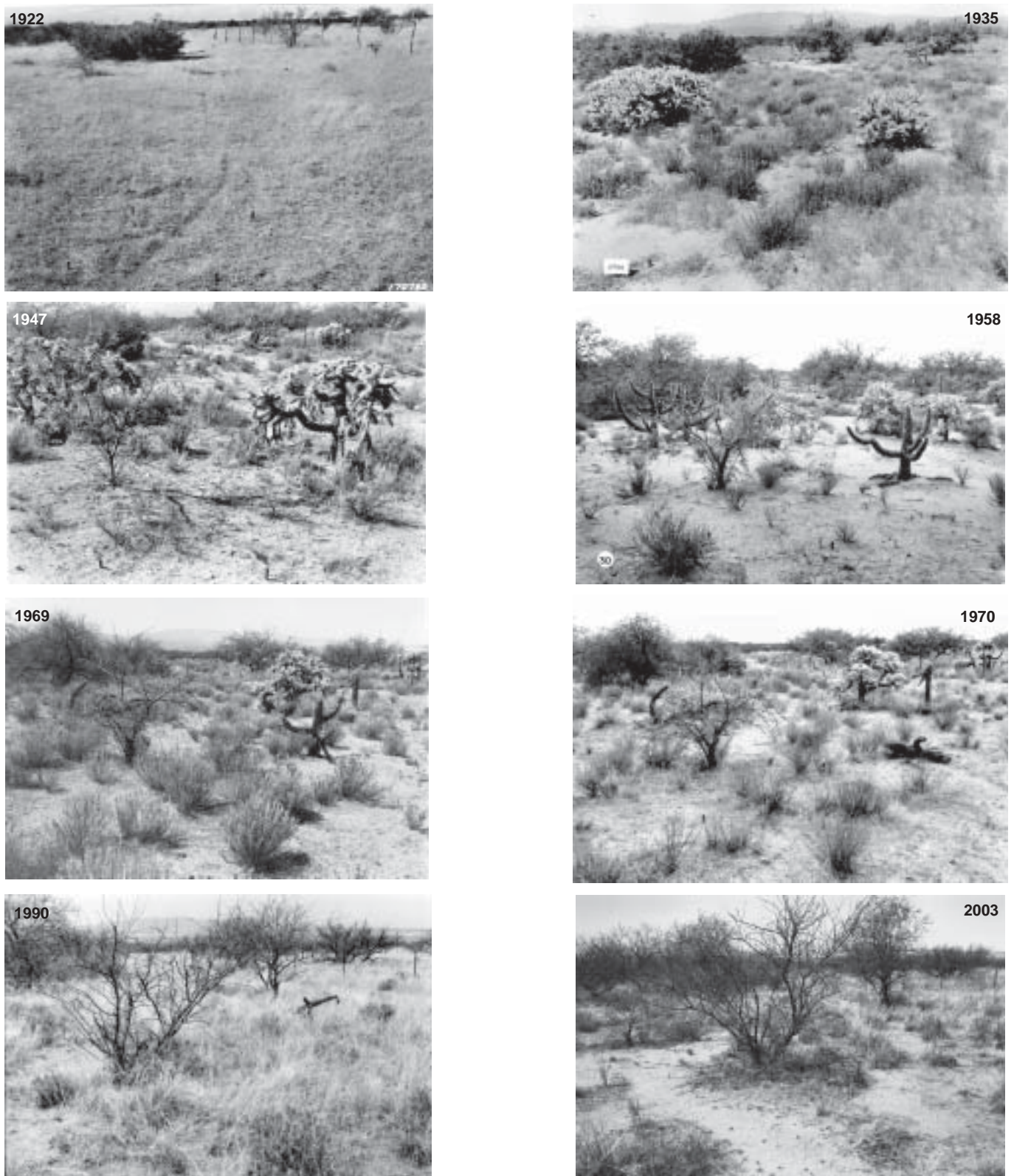

Figure 6—Repeat photography (1922 to 2003) looking west from Photo Station 111 at 1,100-m elevation (McClaran and others 2002). Area beyond fence has been excluded from livestock since 1916. December 1922 shows sparse tree presence and no shrubs in foreground. From September 1935 to October 1947 and August 1958 shows eruptions of burrowweed and cholla, a general decline of grass, and establishment of new mesquite on both sides of the enclosure fence. From March 1969 to July 1970 shows rapid death of burrowweed. March 1990 to April 2003 shows dominance of nonnative Lehmann lovegrass, and decline of burrowweed.

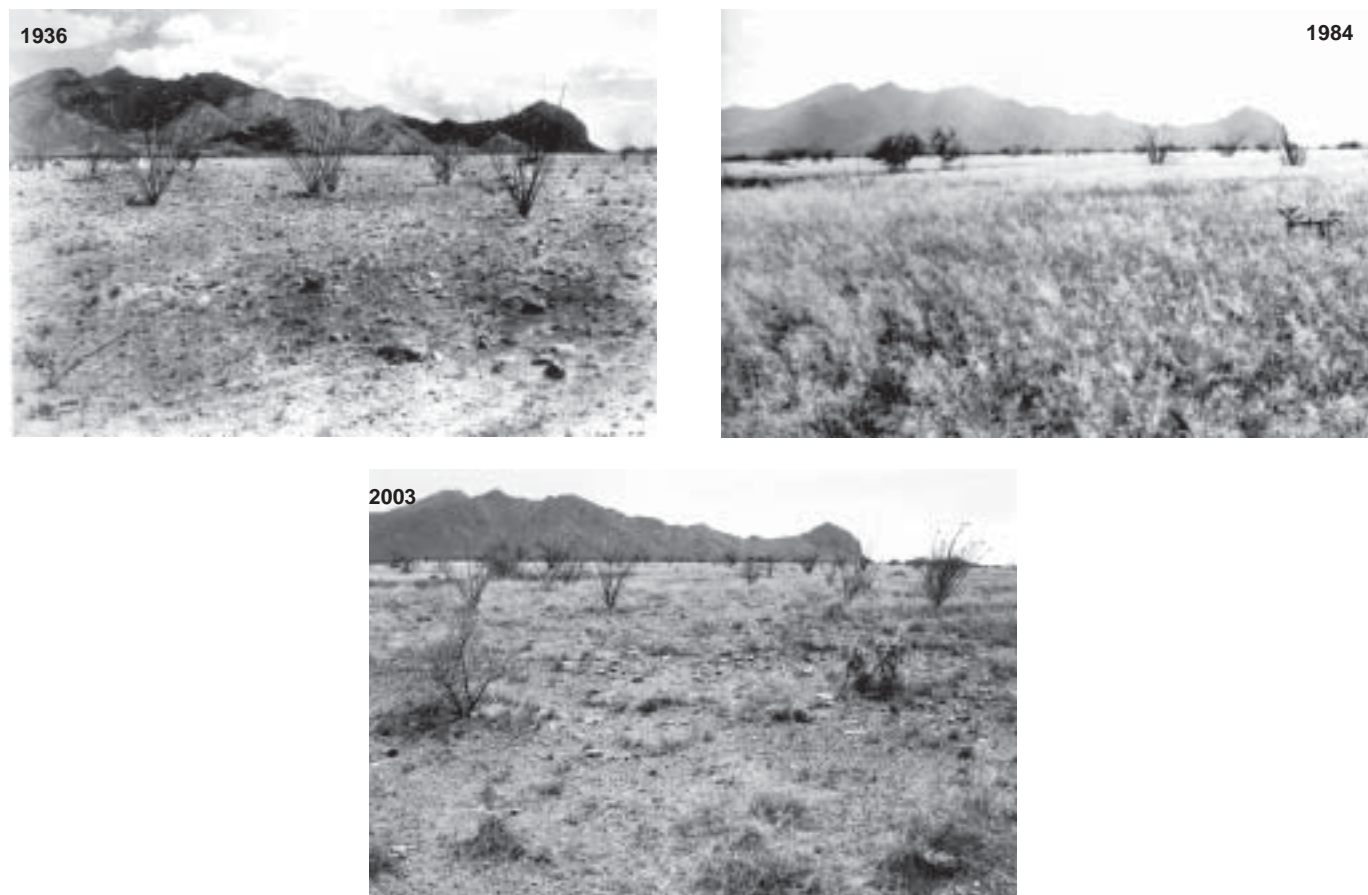

Figure 7—Repeat photography (1936 to 2003) looking east from Photo Station 45 across Madera Canyon alluvial fan at 1,100-m elevation (McClaran and others 2002). In June 1936, there is very sparse grass cover, scattered ocotillo, and three mesquite trees. From 1936 to October 1984, nonnative Lehmann lovegrass arrives and abundance reflects the wet summer in 1984. From 1984 to April 2003 there is a reduction of lovegrass, a continued ocotillo presence, a new catclaw acacia (bottom left), and the persistence of the three mesquite that were present in 1936.

first noted increases at low elevations in the northwestern portion of the Santa Rita that spread upslope to 1,100-m elevation by 1910.

The second cycle occurred in the 1930s. In 1935, Humphrey (1937) observed that large plants were conspicuous everywhere below 1,350-m elevation, and in the early 1940s, Canfield (1948) estimated cover between 4 and 9 percent below 1,250 m. The timing and extent of the subsequent decline is not clear. The extent of the highest density class (greater than 36 plants per m^2) increased only slightly from about 50 to 55 percent of the Santa Rita between 1934 and 1954 (Humphrey and Mehrhoff 1958; Mehrhoff 1955), but significant declines in burroweed by the 1950s are documented in several repeat photography comparisons (for example, fig. 6).

A third cycle peaked in the late 1960s, followed by a decline beginning in 1970 (figs. 6 and 8) over large areas of the Santa Rita. Cover on 120 permanent line intercept transects increased from 2.4 percent in 1957 to 13.5 percent in 1966, then declined to 2.5 percent in 1970 (Martin and Cable 1974). The magnitude of the increase was less on a subset of

these transects without mesquite control, but the timing was identical (fig. 8).

The most recent cycle occurred between the late 1970s and 1990s on large areas of the Santa Rita (figs. 6 and 8). Density increased from 0.6 plants per m^2 in 1972 to 2.7 plants per m^2 in 1975, then declined to 1.1 plants per m^2 in 1984 (Martin and Severson 1988). In general, the density above 1,000-m elevation was about double that below, but the timing of the cycle was synchronous. Comparing density and cover values from 1972 to 2000 (fig. 8) reveals the character of these cycles. Increases in density precedes increases in cover by about 8 to 10 years. Maximum cover mostly occurs when self-thinning reduces density and surviving plants grow larger. Near the end of the cycle, there are declines in both density and cover.

There are some locations where these cycles never materialized, and other locations where some cycles were not expressed. The cycles have not occurred in areas with rocky, clay-rich soils (fig. 7), and there is no evidence that the latest cycle occurred on deep, sandy soils (fig. 3).

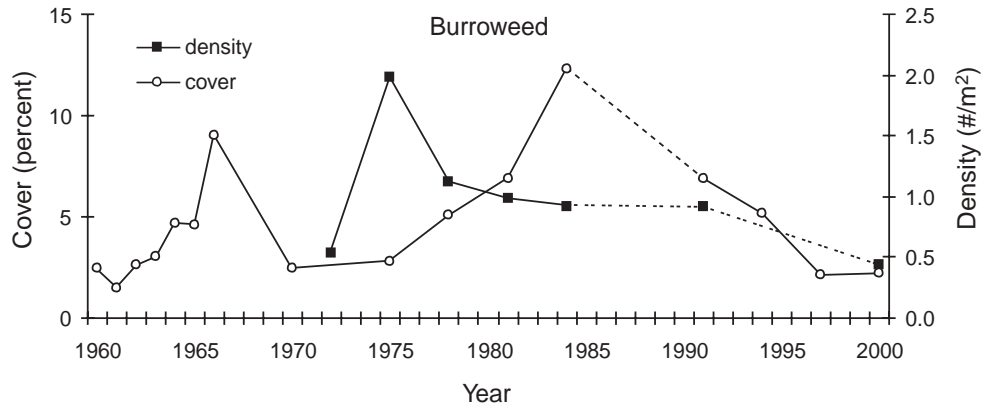

Figure 8—Change in burroweed cover and density on 74 permanent transects between 950- and 1,250-m elevation (McClaran and others 2002). No mesquite or burroweed removal treatments were applied to these transects. Dashed lines indicate periods of greater than 5 years between remeasurements.

Interpretations

The timing of the burroweed cycles appears to be independent of manipulations to livestock grazing, fire, and grass neighbors. If burroweed responded to a manipulation, it was expressed as a short-lived change in abundance that lasted only until the current cycle ended or the next cycle began. An anecdotal consensus has emerged that variation in winter precipitation is driving these cycles because of this relative indifference to livestock grazing, rodents, and fire treatments. This relationship remains anecdotal because the mechanisms have not been documented, and only one correlation analysis has been performed. Similar to mesquite, frequent fires may have limited the distribution of burroweed to lower elevations where fuels did not accumulate.

Cable (1967) placed the emphasis on winter precipitation when the immediate reduction of burroweed density following fires in 1952 and 1955 was undetectable 10 and 13 years later (fig. 9). He found a strong correlation ($r^2 = 0.91$) between burroweed density and winter precipitation between 1952 and 1958 to support his interpretation. Later, Martin (1983) applied this same interpretation (consecutive wet winters in 1977–1978 and 1978–1979) to the short-lived decline of burroweed following a fire in 1975.

The earliest assessments of livestock grazing effects on burroweed occurred near the start of the 1930s cycle. Without the benefit of replications in his study from 1931 to 1948, Brown (1950) concluded that exclusion of livestock may slow a burroweed increase, but it would not prevent one. By the time of the fourth cycle, the winter precipitation explanation was used to account for the indifference to yearlong and rotation of summer grazing from 1972 to 1984 (Martin and Severson 1988).

Between 1961 and 1964, as the third burroweed cycle began, Cable (1969) found that burroweed cover increased slightly less when growing with cottontop grass neighbors (8- to 20-percent increase) than without cottontop neighbors (8- to 27-percent increase). He applied the winter precipitation explanation to this pattern, specifically its relative importance to the two species. Cottontop was largely unresponsive to winter precipitation and, therefore, did not affect

burroweed during the time of its greatest growth. By contrast, the slight depression in burroweed growth was a function of competition for soil moisture in the summer, when cottontop is most actively growing.

There are some additional compelling coincidences of wet winters (fig. 2) and the timing of burroweed cycles. Three consecutive wet winters from 1929–1930 to 1931–1932 coincide with the beginning of the 1930s cycle. The wet winter of 1957–1958 may have initiated seedling establishment for the third cycle, and the very wet 1965–1966 and 1967–1968 winters may have contributed to an increase in plant size.

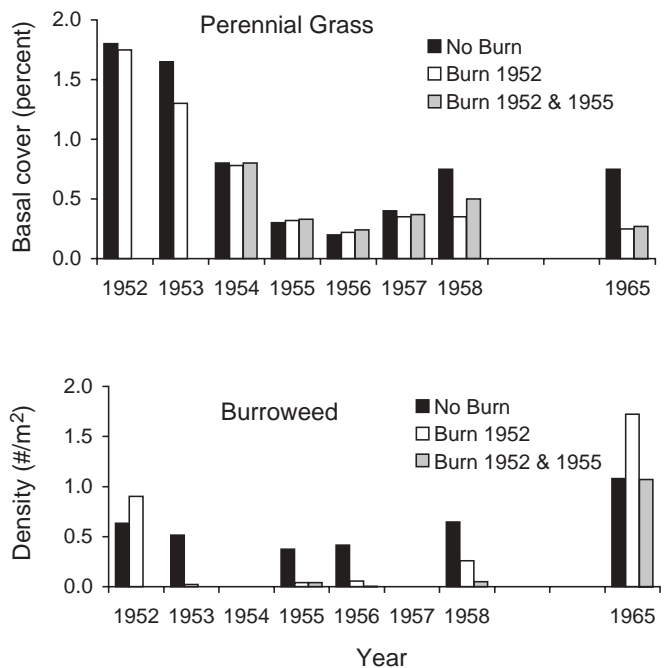

Figure 9—Changes in perennial grass cover and burroweed density in relation to two, one, and no prescribed fires (data from Cable 1967).

Finally, a similar lag between seedling establishment and increases in plant size may have contributed to the most recent cycle following consecutive wet winters in 1977–1978 and 1978–1979. The growth of plants established during this time would likely have been fostered by the extraordinary string of 13 consecutive wet winters from 1982–1983 to 1994–1995.

Changes in Cactus Abundance

The primary cacti are prickly pear, chainfruit cholla, and cane cholla, which are relatively short lived (less than 50 years). The chollas have cylindrical sections, and a growth form that is taller (less than or equal to 2 m) than broad (less than or equal to 1 m); whereas the prickly pear has flat, circular sections with a growth form that is broader (less than or equal to 2 m) than tall (less than or equal to 1 m). Both can establish new plants from seed and from fallen sections that can develop a root system when the areoles are in contact with the soil. However, vegetative reproduction is more common in the chollas than prickly pear.

Pattern

In 1903, cacti were most common below 1,000-m elevation (Griffiths 1904). An eruption of cholla at higher elevations occurred by the mid-1930s and lasted into the 1970s. Prickly pear has been the dominant cactus since 1970.

Many repeat photography series record an eruption of cholla by 1935 (for example, figs. 3 and 6). Between 1934 and 1954, the proportion of the Santa Rita supporting greater than 840 plants per ha doubled from 19 to 38 percent (Humphrey and Mehrhoff 1958; Mehrhoff 1955). The greatest increase occurred between 1,000- and 1,200-m elevation. The eruption faded by 1960, when both cholla cover and density declined (figs. 3, 6, and 10). A similar trend was

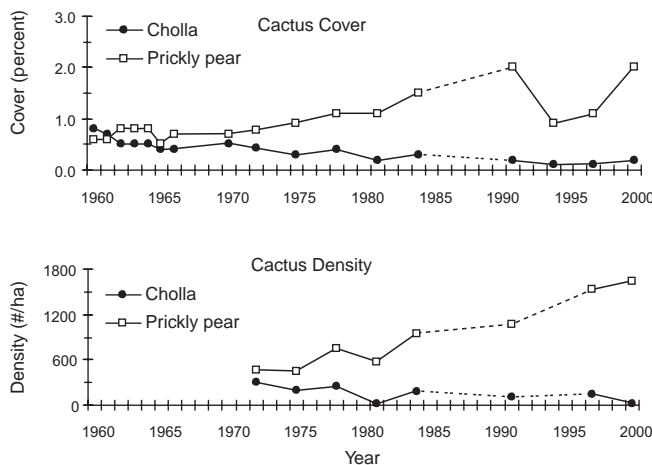

Figure 10—Cover and density changes for cholla and prickly pear cactus on 74 permanent transects between 950- and 1,250-m elevation (McClaran and others 2002). No mesquite or burroweed removal treatments were applied to these transects. Dashed lines indicate periods of greater than 5 years between remeasurements.

recorded between 1972 and 1984 at slightly higher elevations (Martin and Severson 1988). In contrast, prickly pear cover and density have increased since 1970 (figs. 3 and 10), and density of 800 plants per ha at elevations below 1,200 m was greater than the 200 to 400 plants per ha at higher elevations (Martin and Severson 1988).

These patterns have not materialized in all locations. Neither cholla nor prickly pear abundance changed markedly on rocky, clay-rich soils (fig. 7), nor did the prickly pear increase materialize everywhere (for example, fig. 6).

Interpretations

Similar to burroweed, the eruption of cholla and recent increases of prickly pear appear to be largely independent of livestock grazing and fire manipulations. The stimuli for the increases are not clear, but the rate and duration of the increases may be a function of plant growth rate, longevity, and the occurrence of a bacterium.

Combinations of cattle and rodent exclusions established as the cholla eruption commenced failed to produce any differences in cacti densities (Brown 1950; Glendening 1952). Under all treatments, densities increased from tens to hundreds of plants per ha. Similarly, the subsequent decline of cholla and increase of prickly pear between 1972 and 1984 were no different in areas with yearlong versus seasonal rotation of grazing (Martin and Severson 1988). Fire produced only a short-lived decline of cactus density, but within 10 to 13 years after fire, the cactus density exceeded that which existed prior to the fires (Cable 1965).

Tschirley and Wagle (1964) suggested that eruptions are a function of rapid growth by young plants, and that declines result from a combination of plants reaching their maximum age and the increase of bacterial infection that prevents fallen sections from establishing roots. They used repeat photography to estimate the curvilinear vertical growth rate of cholla: the rate is fastest in young plants, then slows considerably at about 15 years, and then becomes negative at about 45 years as plants disarticulate (for example, figs. 3 and 6). They suggested that recruitment of new plants from fallen sections is limited when they are infected by increasing levels of the bacteria *Erwinia carnegiea* that cause the sections to desiccate before roots can be produced.

Changes in Perennial Grass Abundance

The common perennial grass species use the C₄ photosynthetic pathway. Their seed germinates, and plants grow most vigorously in July and August after the summer rains commence. Absolute productivity is a function of both current and previous summer precipitation (Cable 1975), and there is considerable interannual and spatial variation in productivity because rainfall amounts differ greatly between years and with elevation (figs. 1, 2, 11, and 12). Productivity is about 1.6 times greater on clay-rich versus loamy soils (Subirge 1983). Plants are relatively short lived, with averages around 5 to 10 years (Cable 1979; Canfield 1957). Roots are most dense in the upper 15 cm of the soil, but some extend greater than 60 cm deep (Blydenstein 1966; Cable 1969). Several species, including cottontop and bush muhly, are

more common under mesquite trees, but others, including threeawns and Rothrock grama, are more common in open areas (Livingston and others 1997; Van Deren 1993; Yavitt and Smith 1983).

Pattern

In 1903, perennial grasses were largely absent below 1,350-m elevation except along arroyos where tanglehead, sideoats grama, and hairy grama were found (Griffiths 1904). The annual grass, six weeks grama, was dominant at lower elevations. Above 1,100 m, Rothrock grama, black grama, and bush muhly were only occasionally present, the latter primarily under shrubs. By 1909, perennial grass

abundance had increased above 1,075 m: Rothrock, black, and slender grammas between 1,075 and 1,250 m, and threeawns, sprucetop, black, and sideoats grammas above 1,250 m (Griffiths 1910; Thornber 1910).

Six years later, in 1915, perennial grasses were more common between 1,000 and 1,250 m, and under shrubs at the lower elevations when Wooten (1916) estimated the extent of different types of grass species. The annual, six weeks grama, continued as the most common grass on about 12 percent of the Santa Rita, all below 1,000 m. Bush muhly was most common on an equivalent area at those low elevations, but was largely confined beneath shrubs. Rothrock grama was the dominant grass on about 50 percent of the area, mainly between 1,000 and 1,250 m, and the common associates were threeawns, tanglehead, and slender grama. Threeawns were the dominants above 1,250-m elevation, which accounted for 17 percent of the Santa Rita.

Griffiths, and later Wooten, estimated productivity by clipping twenty-eight 0.9- by 2.1-m (3- by 7-ft) plots in the same general locations throughout the Santa Rita between 1903 and 1908, and 1912 and 1914. The average for all elevations was 845 kg per ha from 1903 to 1908 (Griffiths 1910). Wooten (1916) reported productivity by elevation between 1912 and 1914: 775 kg per ha below 1,000 m, 830 kg per ha between 1,000 and 1,250 m, and 965 kg per ha above 1,250 m.

Between 1915 and the early 1980s, similar patterns of perennial species abundance were reported in relation to elevation, and more systematic measures of plant cover, density, and productivity provided greater insights to interannual dynamics. From the 1960s to early 1980s, dominant species by elevation were similar to those reported in earlier accounts, but cottontop was more common at all elevations (Cable 1979; Martin 1966; Martin and Severson 1988). The ephemeral nature and slight stature of Rothrock grama is illustrated by its inconsistent membership in the top 5 ranking for density and consistently low ranking for cover (tables 2 and 3). Interannual variability of productivity was greater at lower elevations between 1954 and 1964 (compare figs. 11 and 12; Martin 1966). Interestingly, these estimates are about one-third to one-half the amounts reported by Griffiths (1910) and Wooten (1916). Their objective of estimating the potential productivity may have biased the location of sample areas toward the more productive sites. A decrease in grass production by 1950 is apparent at some repeat photography locations (fig. 4), but not at others (fig. 3).

The nonnative Lehmann lovegrass became the most abundant perennial grass by 1981 and 1984, based on density and basal cover, respectively (tables 2 and 3). By 1991, it was more common than all native grasses combined for both measures of abundance (fig. 13). Above about 1,100-m elevation, perennial grass productivity has more than doubled since the lovegrass gained dominance (fig. 13; Anable and others 1992; Cox and others 1990), and exceeded estimates made between 1903 and 1914 (Griffiths 1910; Wooten 1916). This was a very rapid ascent to dominance from a relatively limited area of introduction. Between about 1945 and 1975, seed was sown on about 50 areas, totaling 200 ha (less than 1 percent of the Santa Rita), but the areas were widely dispersed making the maximum distance between them less than or equal to 7 km (Anable and others 1992). This lovegrass invasion is obvious at most repeat photography

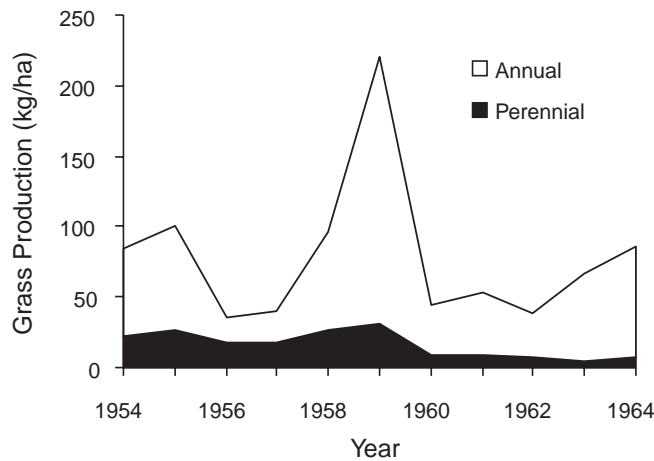

Figure 11—Interannual changes in grass production between 900- and 1,000-m elevation (data from Martin 1966).

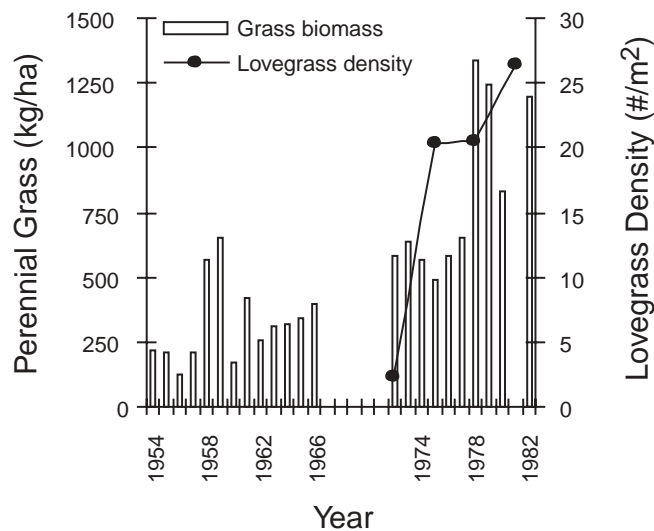

Figure 12—Interannual changes in grass production and density of nonnative Lehmann lovegrass at 1,100-m elevation (data from Cable and Martin 1975, and Martin and Severson 1988).

Table 2—Changes in the five most common perennial grass species based on density on the Santa Rita Experimental Range, 1934 to 2000. Source for 1934 and 1954 is Mehrhoff (1955). Source for other dates is from 74 permanent transects, between 950- and 1,250-m elevation, where no mesquite or burroweed removal treatments were applied (McClaran and others 2002).

Species rank	Year					
	1934	1954	1972	1981	1991	2000
1	Rothrock grama	Fluff grass	Threeawns	Lehmann lovegrass	Lehmann lovegrass	Lehmann lovegrass
2	Threeawns	Black grama	Rothrock grama	Threeawns	Rothrock grama	Rothrock grama
3	Fluff grass	Threeawns	Cottontop	Rothrock grama	Cottontop	Threeawns
4	Slender grama	Slender grama	Black grama	Cottontop	Fluff grass	Bush muhly
5	Black grama	Cottontop	Sprucetop grama	Bush muhly	Threeawns	Cottontop

Table 3—Changes in the five most common perennial grass species based on basal cover on the Santa Rita Experimental Range, 1960 to 2000. Source is from 74 permanent transects, between 950- and 1,250-m elevation, where no mesquite or burroweed removal treatments were applied (McClaran and others 2002).

Species rank	Year				
	1960	1970	1984	1991	2000
1	Threeawns	Threeawns	Lehmann lovegrass	Lehmann lovegrass	Lehmann lovegrass
2	Cottontop	Sprucetop grama	Threeawns	Cottontop	Bush muhly
3	Black grama	Cottontop	Cottontop	Bush muhly	Threeawns
4	Bush muhly	Rothrock grama	Rothrock grama	Threeawns	Rothrock grama
5	Sideoats grama	Sideoats grama	Black grama	Rothrock grama	Cottontop

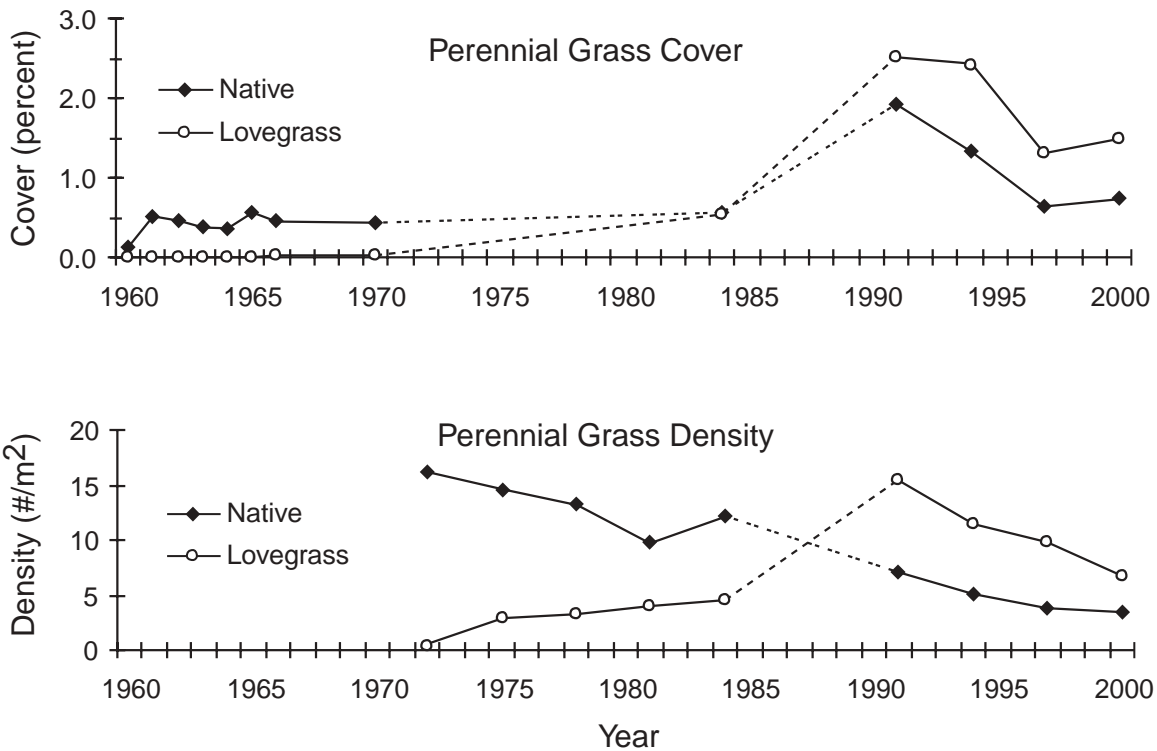

Figure 13—Cover and density changes for nonnative Lehmann lovegrass and native perennial grasses on 74 permanent transects between 950- and 1,250-m elevation (McClaran and others 2002). No mesquite or burroweed removal treatments were applied to these transects. Dashed lines indicate periods of greater than 5 years between remeasurements.

locations (for example, figs. 6 and 7), except at the lowest elevations and on deep, sandy soils (fig. 3).

Between 1984 and 1991, cover increased for both the lovegrass and native grasses, but both have declined from that maximum. In contrast, native grass density declined since 1972, whereas lovegrass density steadily increased until 1991 and then began to decline (fig. 13). These patterns suggest that the recruitment of native grasses has declined and the size of surviving plants has increased since the lovegrass gained dominance.

Interpretations

Livestock grazing, fire, neighboring mesquite and burroweed plants, and the increase of the nonnative Lehmann lovegrass have been the focus of efforts to interpret perennial grass dynamics. The results from a number of studies illustrate the important and often overriding influence of precipitation on these patterns. However, grass dynamics appear to be more sensitive to varying intensities of livestock grazing and neighboring plants than the dynamics expressed by mesquite, burroweed, and cactus.

Attention to livestock grazing has a longer and more detailed history than any other influence. It grew directly from the objectives of establishing the Santa Rita, which were to determine the potential of forage production for livestock and to develop a sustainable approach to livestock grazing. Initial efforts focused on rates of grass recovery following grazing removal, while subsequent studies addressed responses to different grazing intensities and the seasonal rotation of pastures to prevent grazing in two of three summer growing seasons.

Livestock Exclusion—The exclusion of livestock from 1903 to 1915 on all areas below 1,250-m elevation allowed Wooten (1916) to speculate on the rate of recovery to full productive potential from the degraded conditions caused by nearly two decades of overgrazing. He estimated a 3-year recovery rate for areas dominated by Rothrock grama between 1,000 to 1,250 m, and a 7- to 8-year recovery for bush muhly in areas below 1,000 m. However, subsequent comparisons with livestock exclusion are more equivocal. Total grass cover declined from about 2.0 to 0.1 percent on grazed areas as well as all combinations of rodent and/or cattle exclusion from 1932 to 1949 (Glendening 1952). Compared to adjacent grazed areas, native grass density was less and nonnative lovegrass was no different in areas that were ungrazed from 1918 to 1990 (McClaran and Anable 1992).

These contrasting results suggest that the perennial grass response to the exclusion of livestock is contingent on the condition of grass at the time of exclusion, precipitation patterns before the comparisons, and the grazing intensity outside the enclosure. Wooten may have proposed very optimistic recovery rates because the general absence of perennials in 1903 provided a degraded baseline, and the relatively verdant conditions during his observations in 1915 following six consecutive summers with above average precipitation (fig. 2). In contrast, the decline of grass cover between 1932 and 1949, which was independent of livestock exclusion, began with relatively large cover values that followed the wet summer in 1931 and declined during the subsequent, prolonged dry period (figs. 2 and 6). Finally,

grazing intensity outside enclosures is not uniform across the Santa Rita, and has changed over time since grazing was re-established in 1915. Therefore, unequivocal conclusions about grass response to livestock exclusion are not possible unless the grazing intensity outside the enclosure is documented.

Livestock Grazing Intensity—In general, grazing intensity on the Santa Rita has declined since 1915. Until 1941, the stocking rate was about 0.13 animals per ha per year. Between 1941 and 1956, it was reduced to about 0.06, which translated to a 47- to 60-percent utilization of grass production. Since 1957, stocking rates have been reduced to about 50-percent utilization (Cable and Martin 1975). A utilization rate of 40 percent was suggested in the early 1940s to prevent damage to individual plants (Parker and Glendening 1942; Reynolds and Martin 1968). However, despite repeated attempts to reduce utilization, this goal of 40 percent was never achieved (Cable and Martin 1975; Martin and Severson 1988). Across the Santa Rita, utilization varies inversely with distance from drinking water sources (Angell and McClaran 2001; Martin and Cable 1974).

Canfield (1948) made the first estimate of grass response to grazing intensity. He compared the relative cover of grass species among areas heavily grazed for 20 years, conservatively grazed for 5 years, and ungrazed for 5 and 25 years. He concluded that conservative grazing for 5 years would facilitate recovery from overgrazing to the same degree as grazing exclusion, and that dominance by cottontop indicated proper grazing intensity. Unfortunately, he provided neither descriptions of stocking rates in overgrazed and conservatively grazed areas nor estimates of absolute cover of grasses. However, his list of dominant grass species in these settings is historically significant because it provided the first quantitative approach using relative cover to identify species that indicated proper grazing and overgrazing. His work preceded by 1 year, Dyksterhuis' (1949) more widely used proposal for this approach.

Martin and Cable (1974) clearly documented the influence of grazing intensity on grass production by comparing sites where utilization decreased with increasing distance from drinking water sources. From 1954 to 1966, and between 900- and 1,250-m elevation, production of cottontop, black grama, and threeawns at 0.4 to 1 km from water was 50 percent less than at 1.6 km from water sources. Utilization decreased from around 48 to 43 percent at these increasing distances from water.

Between 1,200 and 1,300 m, Cable and Martin (1975) suggested that the recovery of grass production from drought stress would be delayed when utilization levels exceeded 50 percent. Based on responses during dry conditions (1957, 1960, and 1962) and wetter conditions (1958, 1959, and 1961), plant recovery was delayed from 1 to 2 years if utilization exceeded 50 percent.

However, differences in the response of native grass and nonnative Lehmann lovegrass density to increasing grazing intensity are less clear. Using a similar approach of increasing distance from water, McClaran and Anable (1992) reported a greater decline of native grass density from 1972 to 1990 with increasing grazing intensity, but Angell and McClaran (2001) reported no relationship with intensity from 1972 to 2000. In both studies, increased density of the

nonnative Lehmann lovegrass was unrelated to grazing intensity. These results for grazing impacts may differ because the two measures of response (biomass and density) may differ in their sensitivity to grazing. Density represents the number of plants, whereas biomass reflects their total weight. The earliest studies (Cable and Martin 1975; Martin and Cable 1974) measured biomass, while the more recent studies (Angell and McClaran 2001; McClaran and Anable 1992) measured density. In addition, McClaran and Anable (1992) relied on only a single water source.

More importantly, the intensity levels for the later studies were greater (60 percent at 0.1 km and 48 percent at 0.5 km) than the earlier studies (48 percent at 0.4 km and 43 percent at 1.6 km). There may be little difference in grass response between 50- and 60-percent utilization, but those responses will be more severe than where utilization is less than 45 percent. This observation is supported by suggestions that a 40-percent utilization rate will not damage these grasses (Parker and Glendening 1942; Reynolds and Martin 1968).

Seasonal Rotation of Grazing—Between 1972 and 1984, neither grass density nor production differed between areas experiencing yearround grazing and those where the rotation of livestock excluded summer grazing in 2 of 3 years (Martin and Severson 1988). Three pastures were used to achieve this rotation, and all animals from those pastures were confined to a single pasture for 4 to 8 consecutive months, followed by a period of 8 to 12 months of no grazing. During the study, utilization levels were 47 to 51 percent. Contrary to expectations, the provision of summer rest did not improve grass abundance. The authors suggested that at the beginning of the study, grass abundance was near maximum, and therefore was unresponsive to this treatment. Additional considerations must include the increase of lovegrass through the period, the very wet conditions through the 1980s (fig. 2), and utilization levels above the 40- to 45-percent threshold.

Effects of Fire—In general, grass abundance decreases following fire, and the recovery is dependent on subsequent growing conditions. However, seed germination of the nonnative lovegrass increases after fire.

In 1952, following the first of two prescribed fires, grass cover declined from 1.7 to 1.1 percent, but cover had already declined to 0.5 percent on both burned and unburned areas prior to the second fire in 1955 (Cable 1967). Cover declined to 0.3 percent on all three treatments in 1957, and the unburned site reached 0.8 percent cover by 1965 (fig. 9). These dynamics reflect the overriding influence of dry conditions between 1952 and 1957 (fig. 2). Cable (1965) found only lovegrass seedlings following a wildfire in June 1963, and later research revealed that lovegrass seed germination increases equally after fire and the simple removal of plant cover (Sumrall and others 1991). In both instances, seed germination is stimulated by a phytochrome response to increased red light rather than heat from the fire (Roundy and others 1992).

Effects of Mesquite—The influence of neighboring mesquite trees on perennial grass appears to be contingent on elevation, amount of mesquite, and the species of grass. Beginning in the 1940s, observations of coincident declines in grass and increases in mesquite stimulated several tree-removal studies. Fortunately, some of them had repeated

measurements performed over the following 40 years. Based on these observations, increased grass production following tree removal is most persistent at higher elevations, and is related to the tree density before removal. For example, tree removal in 1945 increased grass production during the first 5 years at all four sites, which ranged from 950- to 1,250-m elevation, but increases were greatest at 1,250 m and where initial tree density was greater than 300 plants per ha (Parker and Martin 1952). After 13 years, native grass production was greater in mesquite-cleared areas above 950 m and where initial tree density was greater than 100 plants per ha (Cable 1971). After 23 years, production was greater for native grasses only at 1,250 m and where initial tree density was greater than 300 plants per ha (Cable 1971). After 29 years, grass production was greater only at 1,250 m, but the nonnative lovegrass dominated the grass composition by that time (Williams 1976).

The relatively brief increase of grass production is probably a function of both the recruitment of new mesquite trees and the depletion of soil fertility after their removal. Tree recruitment prompted Parker and Martin (1952) to suggest that tree removal would be required every 25 years to maintain grass production. An island of soil fertility develops under mesquite. About three times more organic matter and nitrogen exists in the top 7.5 cm of soil compared to open grassland, and 13 years after tree removal there is a 30 percent decline of organic matter and nitrogen (Klemmedson and Tiedemann 1986; Tiedemann and Klemmedson 1986).

This greater soil fertility under mesquite trees may contribute to the greater likelihood of some grasses to occur under the trees. Several species, including cottontop and bush muhly are more common under mesquite than if they were randomly distributed (Livingston and others 1997; Van Deren 1993; Yavitt and Smith 1983). Tiedemann and others (1971) suggested that the greater soil fertility under mesquite might compensate for the lower light intensity for those species that are shade tolerant.

It is important to note that increases of native and nonnative lovegrass have occurred without mesquite removal, and can occur while mesquite is increasing. From 1960 to 1991, at elevations between 900 and 1,250 m, native and nonnative grass cover more than doubled, while mesquite cover increased from 7 to 20 percent (figs. 5 and 13).

The rate that Lehmann lovegrass spreads from seeded areas is not related to the abundance of mesquite. Lovegrass was seeded on the margins of the areas where mesquite trees were thinned and removed in 1945 (Parker and Martin 1952). After 13 years, it had spread 75 to 125 m regardless of mesquite treatment, and its density increased with elevation (Kincaid and others 1959). After 25 years, lovegrass productivity did not differ among mesquite treatments, but it did increase with elevation (Cable 1971). This is consistent with Van Deren's (1993) finding that the proportion of lovegrass plants under mesquite is only slightly less than would be expected randomly.

Effects of Burroweed—The response of perennial grass to burroweed neighbors appears to be contingent on amounts of winter and summer precipitation. In 1961, Cable (1969) removed some existing burroweed plants to create cottontop plants without burroweed neighbors. Cottontop production did not differ between treatments, but cover differed in the last 2 years of the study. In the very dry summer of 1962,

cottontop cover was no different between treatments, but in the following summers that had greater precipitation, cover was greater for cottontop plants without burrowweed. Cable (1969) demonstrated that basal cover was reduced because burrowweed used soil moisture during the winter when grass tillers were enlarging, rather than preemptive use of water by burrowweed in the summer. This relationship may explain why total grass cover did not respond to burrowweed removal at 1,100-m elevation in the generally dry periods between 1940 and 1946 (Parker and Martin 1952).

Native and Nonnative Grass Relationships—The inverse relationship between the increasing abundance of the nonnative Lehmann lovegrass and declining native grasses appears to be more closely related to events during seedling establishment than to interactions among adult plants. Initially, the lovegrass invasion appears to occur between existing native grasses, thus increasing total grass density and productivity, but eventually native grasses are replaced (fig. 13; Anable and others 1992; Angell and McClaran 2001; Kincaid and others 1959). The timing and magnitude of the native grass decline between 1972 and 2000 did not differ in relation to the length of time that lovegrass had been present in an area (Angell and McClaran 2001). In addition, all evidence suggests that the increase of lovegrass is as indifferent to the abundance of native grasses (Angell and McClaran 2001; McClaran and Anable 1992) as it is to the abundance of mesquite (Kincaid and others 1959). The unique response of lovegrass seed to the first summer rains may be a more important key to its highly successful recruitment. Abbott and Roundy (2003) reported that native grasses were more likely to germinate with the first summer rains than lovegrass, and therefore would suffer from the rapid soil desiccation that follows these sporadic first rains. In contrast, lovegrass germination was more likely to be delayed and follow the more regularly occurring later rains, when prolonged soil moisture and survival were more likely.

Opportunities

Continuing the systematic remeasurement and repeat photography efforts on the Santa Rita presents the greatest opportunity for improving our understanding of vegetation change because they will record the pattern and variation of future changes. The most incontestable conclusion from this century of vegetation change is that future changes can not be perceived and understood if there are no records of previous conditions. An equally important conclusion is that the response of vegetation to management practices will be contingent on past and future precipitation patterns, elevation and soils at the location, and the current mix and vigor of plant species. For example, when the next burrowweed eruption occurs, we will respond with much less anxiety than our predecessors had in the 1930s and 1950s because we understand that it is likely to be a short-lived rather than permanent change. We will not expect the eruption to occur at all locations, nor will the control of that eruption prevent future eruptions. Given the importance of this observation legacy, its continuation should be considered both an opportunity and an obligation.

In addition to continuing the ongoing remeasurements, there are several opportunities to further the documentation

and understanding of both past and future vegetation changes. Most of the areas that experienced experimental manipulations were measured for less than 5 years. Remeasuring vegetation in those areas can provide insights into the longevity of responses and the variation expressed in recent changes such as the spread of Lehmann lovegrass.

A re-evaluation of these old data sets may reveal patterns and suggest processes that were not originally apparent. These re-evaluations will certainly benefit from the application of new methods of statistical analysis such as repeated measures and mixed-effects models of analysis of variance, classification, and regression tree analysis. In addition, spatial analyses of these data sets have been facilitated by the creation of a digital archive that is available on the World Wide Web (McClaran and others 2002).

The establishment of any new experimental manipulations is given invaluable direction by these long-term records. In return, these new manipulations should be located where they will not conflict with ongoing remeasurements or opportunities to remeasure past manipulations. Finally, all efforts should be made to foster the long-term remeasurement of these new manipulations beyond the common 3 to 5 years. No message is clearer from this century of change than the certainty that the initial response to manipulations will not persist with time.

There are specific research questions that are stimulated by this legacy of observation. Given the initial focus on grass dynamics, efforts focused on the current grassland dominated by Lehmann lovegrass deserve attention. How long will the dominance persist, and will the absolute abundance (cover, density, and biomass) stabilize, increase, or decline? Will lovegrass dominance directly alter the expected patterns of mesquite seedling recruitment, and future eruptions of burrowweed and cactus? Will these patterns be altered indirectly by the lovegrass because its abundant biomass will facilitate and support more frequent fire? Does the proposed grazing intensity threshold of 45-percent utilization apply equally to lovegrass and native grasses?

Regarding mesquite, what are the maximum cover, density, and productivity per area for the species? Glendening (1952) predicted a maximum of 30-percent cover, but that mark has not been reached on the majority of the Santa Rita. The development of a soil fertility island beneath mesquite trees has been documented (Klemmedson and Tiedemann 1986; Tiedemann and Klemmedson 1986). What are the limits to this accumulation, how deep in the soil will fertility eventually increase, and how long will it last after trees are removed? These patterns are important to neighbor plants, and they are globally important because they address interests in the sequestration of atmospheric CO₂ through vegetation management.

Consulting past records, maintaining ongoing remeasurements and initiating new manipulations can advance the prediction of future burrowweed and cactus eruptions. The timing and duration of past eruptions were not entirely synchronized. The degree and spatial pattern of their asynchrony should be possible with repeat photography and the network of 30 rain gauges (McClaran and others 2002). Further investigation of the potential role of bacterial infection on cactus populations should also occur.

Finally, this accumulation of information should prove useful in evaluating both theoretical and practical issues of

rangeland vegetation ecology and management. For example, the gradients of livestock use intensity and precipitation records could be used to evaluate the theoretical propositions of equilibrium versus nonequilibrium controls on vegetation change (Illius and O'Connor 1999). Practically, the rich empirical information and documentation of contingencies such as soils, precipitation patterns, and pre-existing species composition could be used to construct a catalog of vegetation states and the events that led to transitions between those states (Westoby and others 1989).

It is obvious that the vast opportunities for future research into the patterns, mechanisms, and implications of vegetation changes are built on the rich legacy of a century of observation and research. In addition to opportunities, there are obligations to maintain and add to this legacy. Therefore, one of our goals should be that during the bicentennial celebration, our future efforts should ensure a second century of research on the Santa Rita.

References

- Abbott, L. B.; Roundy, B. A. 2003. Available water influences field germination and recruitment of seeded grasses. *Journal of Range Management*. 56: 56–64.
- Anable, M. E.; McClaran, M. P.; Ruyle, G. B. 1992. Spread of introduced Lehmann lovegrass *Eragrostis lehmanniana* Nees in southern Arizona, U.S.A. *Biological Conservation*. 61: 181–188.
- Angell, D. L.; McClaran, M. P. 2001. Long-term influences of livestock management and a nonnative grass on grass dynamics on the desert grassland. *Journal of Arid Environments*. 49: 507–520.
- Bahre, C. J.; Shelton, M. L. 1996. Rangeland destruction: cattle and drought in southeastern Arizona at the turn of the century. *Journal of the Southwest*. 38: 1–22.
- Blydenstein, J. 1966. Root systems of four desert grassland species on grazed and protected sites. *Journal of Range Management*. 19: 93–95.
- Brown, A. L. 1950. Shrub invasion of a southern Arizona desert grassland. *Journal of Range Management*. 3: 172–177.
- Cable, D. R. 1961. Small velvet mesquite seedlings survive burning. *Journal of Range Management*. 14: 160–161.
- Cable, D. R. 1965. Damage to mesquite, Lehmann lovegrass, and black grama by a hot June fire. *Journal of Range Management*. 18: 326–329.
- Cable, D. R. 1967. Fire effects on semidesert grasses and shrubs. *Journal of Range Management*. 20: 170–176.
- Cable, D. R. 1969. Competition in the semidesert grass-shrub type as influenced by root systems, growth habits, and soil moisture extraction. *Ecology*. 50: 27–38.
- Cable, D. R. 1971. Lehmann lovegrass on the Santa Rita Experimental Range, 1937–1968. *Journal of Range Management*. 24: 17–21.
- Cable, D. R. 1975. Influence of precipitation on perennial grass production in the semidesert Southwest. *Ecology*. 56: 981–986.
- Cable, D. R. 1977. Seasonal use of soil water by native velvet mesquite. *Journal of Range Management*. 30: 4–11.
- Cable, D. R. 1979. Ecology of Arizona cottontop. Res. Pap. RM-209. Fort Collins, CO: U.S. Department of Agriculture, Forest Service, Rocky Mountain Forest and Range Experiment Station. 21 p.
- Cable, D. R.; Martin, S. C. 1975. Vegetation responses to grazing, rainfall, site condition, and mesquite control on a semidesert range. Res. Pap. RM-149. Fort Collins, CO: U.S. Department of Agriculture, Forest Service, Rocky Mountain Forest and Range Experiment Station. 24 p.
- Canfield, R. H. 1942. Sampling ranges by the line intercept method: plant cover, composition, density, and degree of forage use. Res. Rep. 4. Tucson, AZ: U.S. Department of Agriculture, Forest Service, Southwestern Forest and Range Experiment Station. 21 p.
- Canfield, R. H. 1948. Perennial grass composition as an indicator of condition of southwestern mixed grass ranges. *Ecology*. 29: 190–204.
- Canfield, R. H. 1957. Reproduction and life span of some perennial grasses of southern Arizona. *Journal of Range Management*. 10: 199–203.
- Cox, J. R.; de Alba-Avila, A.; Rice, R. W.; Cox, J. N. 1993. Biological and physical factors influencing *Acacia constricta* and *Prosopis velutina* establishment in the Sonoran Desert. *Journal of Range Management*. 46: 43–48.
- Cox, J. R.; Ruyle, G. B.; Roundy, B. A. 1990. Lehmann lovegrass in southern Arizona: biomass production and disappearance. *Journal of Range Management*. 43: 367–372.
- Culley, M. 1938. Densimeter, an instrument for measuring the density of ground cover. *Ecology*. 19: 588–590.
- Dyksterhuis, E. J. 1949. Condition and management of rangeland based on quantitative ecology. *Journal of Range Management*. 2: 104–115.
- Glendening, G. E. 1952. Some quantitative data on the increase of mesquite and cactus on a desert grassland range in southern Arizona. *Ecology*. 33: 319–328.
- Glendening, G. E.; Paulsen, H. A. 1955. Reproduction and establishment of velvet mesquite as related to invasion of semidesert grasslands. Tech. Bull. 1127. Washington, DC: U.S. Department of Agriculture. 50 p.
- Griffiths, D. 1904. Range investigations in southern Arizona. Bull. 67. Washington, DC: U.S. Department of Agriculture, Bureau of Plant Industry. 62 p.
- Griffiths, D. 1910. A protected stock range in Arizona. Bull. 177. Washington, DC: U.S. Department of Agriculture, Bureau of Plant Industry. 27 p.
- Hill, R. R. 1920. Charting quadrats with a pantograph. *Ecology*. 1: 270–273.
- Humphrey, R. R. 1937. Ecology of burroweed. *Ecology*. 18: 1–9.
- Humphrey, R. R. 1958. The desert grassland: a history of vegetational change and analysis of causes. *Botanical Review*. 24: 193–252.
- Humphrey, R. R.; Mehrhoff, L. A. 1958. Vegetation changes on a southern Arizona grassland range. *Ecology*. 39: 720–726.
- Illius, A. W.; O'Connor, T. G. 1999. On the relevance of nonequilibrium concepts to arid and semi-arid grazing systems. *Ecological Applications*. 9: 798–813.
- Kincaid, D. R.; Holt, G. A.; Dalton, P. D.; Tixier, J. S. 1959. The spread of Lehmann lovegrass as affected by mesquite and native perennial grasses. *Ecology*. 40: 738–742.
- Klemmedson, J. O.; Tiedemann, A. R. 1986. Long-term effects of mesquite removal on soil characteristics: II. Nutrient availability. *Soil Science Society of America Journal*. 50: 476–480.
- Livingston, M.; Roundy, B. A.; Smith, S. E. 1997. Association of overstory plant canopies and native grasses in southern Arizona. *Journal of Arid Environments*. 35: 441–449.
- Martin, S. C. 1970. Longevity of velvet mesquite seed in the soil. *Journal of Range Management*. 23: 69–70.
- Martin, S. C. 1966. Santa Rita Experimental Range: a center for research on improvement and management of semidesert rangelands. Res. Pap. RM-22. Fort Collins, CO: U.S. Department of Agriculture, Forest Service, Rocky Mountain Forest and Range Experiment Station. 24 p.
- Martin, S. C. 1983. Responses of semidesert grasses and shrubs to fall burning. *Journal of Range Management*. 36: 604–610.
- Martin, S. C.; Cable, D. R. 1974. Managing semidesert grass-shrub ranges: vegetation responses to precipitation, grazing, soil texture, and mesquite control. Tech. Bull. 1480. Washington, DC: U.S. Department of Agriculture, Forest Service. 45 p.
- Martin, S. C.; Severson, K. E. 1988. Vegetation responses to the Santa Rita grazing system. *Journal of Range Management*. 41: 291–295.
- McClaran, M. P. 1995. Desert grasslands and grasses. In: McClaran, M. P.; Van Devender, T. R., eds. *The Desert Grassland*. Tucson: University of Arizona Press: 1–30.
- McClaran, M. P.; Anable, M. E. 1992. Spread of introduced Lehmann lovegrass along a grazing intensity gradient. *Journal of Applied Ecology*. 29: 92–98.
- McClaran, M. P.; Angell, D. L.; Wissler, C. 2002. Santa Rita Experimental Range digital database user's guide. Gen. Tech. Rep. RMRS-GTR-100. Fort Collins, CO: U.S. Department of Agriculture, Forest Service, Rocky Mountain Research Station. 13 p.
- Medina, A. L. 1996. The Santa Rita Experimental Range: history and annotated bibliography (1903–1988). Gen. Tech. Rep. RM-GTR-276. Fort Collins, CO: U.S. Department of Agriculture,

- Forest Service, Rocky Mountain Forest and Range Experiment Station. 67 p.
- Mehrhoff, L. A., Jr. 1955. Vegetation changes on a southern Arizona grassland—an analysis of causes. Tucson: University of Arizona. 48 p. Thesis.
- Parker, K. W.; Glendening, G. E. 1942. General guide to satisfactory utilization of the principal southwestern range grasses. Res. Note 104. Tucson, AZ: U. S. Department of Agriculture, Forest Service, Southwestern Forest and Range Experiment Station. 4 p.
- Parker, K. W.; Martin, S. C. 1952. The mesquite problem on southern Arizona ranges. Circ. 908. Washington, DC: U.S. Department of Agriculture. 70 p.
- Reynolds, H. G.; Martin, S. C. 1968 (revised). Managing grass-shrub cattle ranges in the Southwest. Agric. Handb. 167. Washington, DC: U.S. Department of Agriculture, Forest Service. 44 p.
- Reynolds, H. G. 1954. Some interrelations of the Merriam kangaroo rat to velvet mesquite. *Journal of Range Management*. 7: 176–180.
- Roundy, B. A.; Taylorson, R. B.; Sumrall, L. B. 1992. Germination responses of Lehmann lovegrass to light. *Journal of Range Management*. 45: 81–84.
- Sumrall, L. B.; Roundy, B. A.; Cox, J. R.; Winkel, V. K. 1991. Influence of canopy removal by burning or clipping on emergence of *Eragrostis lehmanniana* seedlings. *International Journal of Wildland Fire*. 1: 35–40.
- Thorner, J. J. 1910. The grazing ranges of Arizona. Bull. 65. Tucson: University of Arizona, Agricultural Experiment Station. 115 p.
- Subirge, T. G. 1983. Soil-plant relations on the Santa Rita Experimental Range, Arizona. Tucson: University of Arizona. 165 p. Thesis.
- Tiedemann, A. R.; Klemmedson, J. O. 1986. Long-term effects of mesquite removal on soil characteristics: I. Nutrients and bulk density. *Soil Science Society of America Journal*. 50: 472–475.
- Tiedemann, A. R.; Klemmedson, J. O.; Ogden, P. R. 1971. Response of four perennial grasses to shade. *Journal of Range Management*. 24: 442–447.
- Tschirley, F. H.; Martin, S. C. 1961. Burrowweed on southern Arizona range lands. Tech. Bull. 146. Tucson: University of Arizona, Agricultural Experiment Station. 34 p.
- Tschirely, F. H.; Wagle, R. F. 1964. Growth rate and population dynamics of jumping cholla (*Opuntia fulgida* Engelm.). *Journal of the Arizona Academy of Sciences*. 3: 67–71.
- Westoby, M.; Walker, B. H.; Noy-Meir, I. 1989. Opportunistic management for rangelands not at equilibrium. *Journal of Range Management*. 42: 266–274.
- Williams, P. T. 1976. Grass production changes with mesquite (*Prosopis juliflora*) reinvasion in southern Arizona. Tucson: University of Arizona. 37 p. Thesis.
- Womack, J. D. 2000. Mortality and vigor of burned and cut velvet mesquite (*Prosopis velutina* Wooten): the role of basal diameter and number of stems. Tucson: University of Arizona. 61 p. Thesis.
- Wooten, E. O. 1916. Carrying capacity of grazing ranges in southern Arizona. Bull. 367. Washington, DC: U.S. Department of Agriculture. 40 p.
- Van Deren, K. J. 1993. The influence of invasive Lehmann lovegrass on two native grasses in the semi-desert grassland. Tucson: University of Arizona. 69 p. Thesis.
- Yavitt, J. B.; Smith, E. L., Jr. 1983. Spatial patterns of mesquite and associated herbaceous species in an Arizona desert grassland. *American Midland Naturalist*. 109: 89–93.

Rangeland Livestock Production: Developing the Concept of Sustainability on the Santa Rita Experimental Range

Abstract: The Santa Rita Experimental Range (SRER) was established in 1903 at the behest of concerned stockmen and researchers as the first facility in the United States set aside to study range livestock production. At the time, severe overgrazing of the public domain had seriously reduced carrying capacities of Southwestern rangelands. Researchers on the SRER developed and demonstrated the concepts that became the foundation for the art and science of range management. These included improved livestock husbandry methods and an initial understanding of how grazing behavior influenced patterns of vegetation response. The emphasis for range livestock production research, however, quickly focused on stocking levels and adjusting grazing and rest periods in order to maintain or improve the abundance and production of forage grasses. Subsequent research developed and demonstrated methods to achieve sustainable range livestock production based on limited herd flexibility and controlled forage utilization levels determined by stocking and monitoring histories. These concepts, conceived and tested on the SRER, contributed greatly to the foundation of modern range management.

Acknowledgments: Some of the following data sets were accessed via the Santa Rita Experimental Range Digital Database. Funding for the digitization of these data was provided by the USDA Forest Service, Rocky Mountain Research Station, and the University of Arizona. Additionally, much material from the Santa Rita Experimental Range archives was reviewed in the preparation of this manuscript. The effort of those involved in the archiving process is greatly appreciated. The author gratefully acknowledges Don Dwyer, Larry Howery, Barbara Hutchinson, and Phil Ogden for their thoughtful reviews.

Introduction

The Santa Rita Experimental Range (SRER) was established in 1903 when it was fenced out of the public domain. Establishment of the SRER was a direct result of pressure from the livestock industry and concern by university and agency researchers of the time that range productivity, in terms of livestock carrying capacity, had declined considerably. In the preface to Griffiths (1901), agrostologist F. Lawson-Scribner wrote that the “free-range system has led to the ruthless destruction of the native grasses” and stressed the “urgent needs of the stockmen for better range conditions.” Griffiths (1901) recognized that “ranchers and those interested in stock growing are beginning to realize more and more the importance of placing the range management in the hands of some one having authority and an interest in its preservation.” This authority, whether at the State or Federal level, also required scientifically accepted criteria for range management, criteria that needed to be developed and tested. Thus began the application of the art and science of range management to Southwestern rangelands.

The SRER was specifically established to conduct “ecological research related principally to the range livestock industry” (Martin and Reynolds 1973). This research program was developed to provide the science on which to base modern range livestock production. Principle audiences for the research were ranchers and Federal agency field personnel (Roach 1950), particularly the USDA Forest Service, which was assigned to conduct range research in 1915. For nearly eight decades the Forest Service directed the research program on the SRER. Livestock grazing has continued on the SRER, but by the early

George B. Ruyle is Professor and Extension Specialist, Range Management, in the School of Renewable Resources, University of Arizona; e-mail: gruyale@ag.arizona.edu. He holds a B.S. degree from Arizona State University, an M.S. degree from the University of California, Berkeley, and a Ph.D. from Utah State University. He is a Fellow in the Society for Range Management.

In: McClaran, Mitchel P.; Ffolliott, Peter F.; Edminster, Carleton B. tech. coords. Santa Rita Experimental Range: 100 years (1903 to 2003) of accomplishments and contributions; conference proceedings; 2003 October 30–November 1; Tucson, AZ. Proc. RMRS-P-30. Ogden, UT: U.S. Department of Agriculture, Forest Service, Rocky Mountain Research Station.

1970s, research emphasis had shifted to studies on the “impacts of grazing on the ecosystem” and more basic ecological aspects of “semidesert ecosystems” (Martin and Reynolds 1973). A broader audience of “working ecologists” and the “urban public” had also emerged.

The emphasis for research may have been livestock production, but from the beginning, the SRER was a range manager’s place and the range vegetation was their primary focus. Range livestock grazing research on the SRER developed and promoted the concept of conservative use and sustainability. In 1975, Martin wrote that “Research and experience indicate that ranges can be grazed at any time of year without serious detriment if the intensity of grazing is not too severe, and if periods of grazing alternate with suitable periods of rest” (Martin 1975a). The objectives of this paper are to examine the body of knowledge generated on the SRER related to range livestock production systems that led to these beliefs; discuss the concepts, methods, and tools developed to apply them; and present stocking histories that indicate the sustainability of conservative stocking. I provide this manuscript as a tribute to all of the early researchers, but especially to S. Clark Martin who spent much of his long and distinguished career on the Santa Rita.

Grazing History

Early records well document the overstocking and deterioration of southern Arizona rangelands. Livestock were first introduced into southern Arizona in the late 1600s by Father Kino and early Spanish explorers (Allen 1989; Sheridan 1995), but Spanish ranching did not begin in earnest until the beginning of the next century (Sheridan 1995). It is easy to assume that ranges, where adequate water was available, were fully stocked by Spanish and Mexican ranches in the early 1800s. These early ranches were abandoned around 1840, but wild cattle in unknown numbers remained on the ranges. Anglo ranchers began their influx soon after the Civil War (Sheridan 1995). Range cattle, as well as sheep and goat, numbers increased after about 1870 and skyrocketed by the mid-1880s. It was commonly reported that the number of cattle in the Arizona Territory was about 5,000 in 1870, 230,000 in 1880, 650,000 in 1885, and over one million in 1890. Dieoffs followed due to the combined effects of overstocking and drought (Griffiths 1901). Severe summer drought in 1891 and 1892 resulted in cattle losses of up to 75 percent by late spring of 1893 (Martin 1975a). Nonetheless, stocking on Arizona ranges continued to exceed carrying capacities well into the 1900s. Stockmen and government agency researchers alike attributed overstocking to open range policy. It was a direct result of these conditions and the importance of finding ways to stabilize the range livestock industry that led to the establishment of the Santa Rita Experimental Range. The SRER was fenced in 1903, destocked, and allowed ungrazed “recovery” until 1914 (Martin and Reynolds 1973). After 1915 most of the area was continuously grazed until 1957 when various schedules of rest were implemented in study pastures.

Sustainable Grazing

At the beginning of Anglo settlement it was thought that the primary economic resources of the Arizona Territory

would come from minerals, but it was soon determined that rangeland vegetation, especially the *Bouteloua* (grama) grasses in the south, provided a vast forage resource for livestock production. For the range livestock industry to become a stable, long-term, economic base, however, the art and science of range management had to be developed and applied. This became a reality with the establishment of the SRER.

The theory and philosophy of the sustainability of range livestock production was pioneered on the SRER. The concept was variously referred to from the earliest writings as “the amount of stock that these lands will carry profitably year after year” (Griffiths 1904), “keeping utilization in harmony with forage supply” (Roach 1950), “sustained use without deterioration of rangelands” (Reynolds 1954), and providing “relatively stable livestock production without seriously impairing other important resource values” (Martin and Reynolds 1973). Overgrazing was recognized early as the primary deterrent to sustainable range livestock production and characterized by observations such as “the tops are continually eaten to the ground” causing the roots to “gradually become extinct” (Griffiths 1901). The sustained production of perennial grass forage for range livestock production “requires grazing the desirable plants to the proper degree at appropriate times and the optimum distribution of livestock” (Reynolds and Martin 1968). These concepts were developed and applied on the SRER.

Range livestock production was a primary livelihood in Arizona when the SRER was established. While decreasing in economic importance over the years, grazing has continued on Southwestern semidesert ranges. Martin (1975b) stated that these rangelands produced enough beef for nearly 3 million people using only a third of the energy required of other food production systems. The harvesting of range forage, produced almost totally from solar energy, remains the most basic way to convert sunshine to food. Rangeland livestock production remains the most widespread use of Arizona rangelands (Ruyle and others 2000). Range management practices developed on the SRER have allowed ranges to improve and maintain productivity over time, and have led to the continued production of range livestock.

The following describes the primary literature and basic findings that supported the development and application of sustainable range livestock production practices.

Range Management and Livestock Production

Most of the researchers connected with the SRER equated range management with range livestock production. That is, their range management practices were focused on increasing forage for livestock on semidesert ranges. The categories below represent the primary literature related to range livestock production on the SRER. Much of the literature has been reviewed in earlier publications, albeit with a different time reference.

By far the majority of research on the SRER did not focus on livestock per se, although animal weights, especially of weaned calves, were often recorded. Instead, the emphasis was on the range vegetation for the purpose of managing

grazing to improve and/or maintain the amount and distribution of perennial grasses.

Effects of Grazing on Plant Communities

General impacts of open range grazing and unrestricted livestock numbers were well documented at the turn of the century. These included loss of forage productivity and increases in plant species less palatable to livestock, bare ground, and soil erosion. The fact that semidesert ranges were vegetated by bunchgrasses rather than sod-forming grasses increased the susceptibility of the soil surface to "injury by trampling" (Griffiths 1901), which seemed to surprise early observers (Toumey 1891). While overgrazing was known and described, the ecological processes involved were only beginning to be studied in an experimental fashion when the SRER was established.

Grazing can influence all vegetation of the range, primarily through selective herbivory on plant species over time and space. Plants vary greatly in palatability to livestock, and the preferred species tend to get grazed heavily, especially when animals are allowed to graze yearlong (Reynolds and Martin 1968). Selective grazing can change the composition of the plant community and reduce the productivity of the primary forage species. These now well-known processes were demonstrated in descriptive studies and then experimentally in small plot and pasture studies on the SRER.

In addition to the many early comparisons of ungrazed versus heavy, continuous, yearlong grazing, vegetation differences associated with distance from water were demonstrated on a pasture with a single permanent water source, and grazed yearlong for a 38-year period (1930 to 1968) (Martin 1972). Heavy, moderate, and light use zones, moving away from water, were associated with about 70-, 50-, and 25-percent utilization, respectively. Differences in grazing use zones manifested species composition shifts among the palatable perennial grasses. Heavy use (usually over 70 percent by weight) reduced the percent composition of *Bouteloua eriopoda* Torr. (black grama), *Tridens muticus* (Torr.) Nash (slim tridens), and *Muhlenbergia porteri* Scribn. Ex Beal (bush muhly), and favored *Aristida californica* Thurber var. *glabrata* Vasey (Santa Rita threeawn) and *Bouteloua rothrockii* Vasey (Rothrock grama). More moderate stocking was shown to improve composition of the aforementioned midgrasses in later studies. Recovery potential of overgrazed rangeland, although limited by increases in mesquite, had been demonstrated early on the SRER and, along with determining proper stocking levels, were research themes for many years (Wootton 1916).

Early range researchers commonly used various clipping intensities on range grasses to simulate grazing, although the limitations of extrapolating data from clipped plots to pasture level grazing processes were recognized (Culley and others 1933). Clipping studies on the SRER compared intensity and frequency of defoliation on several perennial grasses. Findings demonstrated aboveground production was reduced by 50 percent on plants clipped weekly during the growing season to 1-inch stubble compared to plants clipped to that level only once at the end of the growing season (Reynolds and Martin 1968).

Research also demonstrated plant community differences by comparing protected areas with adjacent areas grazed continuously (Griffiths 1910). Species most abundant under continuous yearlong grazing were *Hilaria belangeri* (Steud.) Nash (curley mesquite), Rothrock grama, and *Bouteloua filiformis* (Fourn.) (slender grama), and species favored by protection were *Digitaria californica* (Benth.) Henr. (Arizona cottontop), bush muhly, black grama, *Bouteloua curtipendula* (Michx.) Torr. (sideoats grama), *Aristida* species (threeawns), *Eragrostis intermedia* Hitchc. (plains lovegrass), and *Leptochloa dubia* (H.B.K.) Nees (green sprangletop) (Canfield 1948; Reynolds and Martin 1968). Grazing pressure resulted in about 50-percent utilization on the group of species most abundant where grazing was continuous and was "much heavier" on the grasses that responded most to protection from grazing. Other studies failed to demonstrate such benefits to the more palatable midgrasses with protection from grazing, especially under moderate use levels (approximately 40 to 60 percent averaged over species and years) (Canfield 1948) or when shrub cover (primarily *Prosopis juliflora* var. *velutina* (Woot.) Sarg. (mesquite)) was dominant (Caraher 1970; Glendening 1952).

General Range Animal Husbandry

Many changes were seen in the principles and methods of raising cattle in the Southwest during the first several decades after establishment of the SRER. The Superintendent of the SRER from 1921 to 1950, Matt Culley, recognized that modern business and range management methods were necessary for ranching success. Most ranches were "run as breeding operations" with the chief source of income being calves sold in the fall or as yearlings the following year (Culley 1946a). Therefore, the percentage of calves produced was of extreme importance. Research on the SRER suggested several factors that increased herd production and earnings (Culley 1937a, 1946a,b,c, 1947, 1948). These included "stocking the range on the basis of sustained yield," reducing pasture size, increasing watering places, regulating the breeding season, and reducing death loss. Improving general management practices with mechanical livestock handling aids was also suggested. Marketing strategies were also evaluated, but as Parker (1943) wrote, "the condition of the range should always be considered first" in deciding when to sell the animals. Such a strategy required a flexible approach to fall weaning and culling. In good years calves could be held over, and in drought conditions even breeding cows might need to be sold.

Although influenced by grazing pressure and the impact of droughts on forage production, calf crop and calf weights increased remarkably on the SRER after the 1920s, due to general improvements in animal genetics and handling methods (Reynolds 1954) as well as reductions in grazing pressure (Martin 1943). For example, in the 1943 *Hereford Journal*, Martin reported increased average annual calf production per cow was 192 pounds to 368 pounds, depending on stocking rates that ranged from 30 to 70 acres per cow. The average cow produced 44 pounds more in calf weight with each additional 10 acres of range she was allowed to

graze. Improvements in the kind of cattle, in terms of breeding, nutrition, and culling practices, also contributed to these gains. Hereford cattle predominated on the SRER for much of its history, but after the mid-1960s they were gradually being replaced with crossbred herds (Culley 1946b; Martin 1975a).

Grazing Behavior

Grazing Habits—An important aspect of effective range management is the study of grazing behavior of cattle on the range (Culley 1937b, 1938a). Culley was interested in the relative preference by cattle for different forage plants as well as the general grazing behavior of cattle. He determined that some forage species were grazed “indiscriminately” year round while others were primarily selected seasonally. Culley also described cattle grazing patterns and activity budgets on a seasonal basis. He reported summer and winter grazing periods of 7 and 8 hours a day, and spring grazing averaged 9 hours daily. Fall and early summer grazing was confined to grasses along washes. Mesquite and *Acacia greggii* A. Gray (catclaw) were used during the winter and late spring, and other shrubs were browsed throughout most of the year. Zemo and Klemmedson (1970) further quantified activity budgets using fistulated steers and concluded that their experimental animals responded in a similar fashion to intact animals as reported in other studies. However, they did record a higher amount of night grazing than most other observations.

Gamougoun (1987) related cattle activity budgets to characteristics of available forage. He found that cattle grazed longer during the summer than in winter and walked more in heavily grazed pastures than in more moderately grazed areas. Gomes (1983) compared behavioral activities of Hereford and Barzona cows and recorded almost identical daily activities.

Ruyle and Rice (1996) described more recent and detailed cattle feeding behavior studies conducted in pastures on the SRER that primarily supported *Eragrostis lehmanniana* Nees (Lehmann lovegrass) stands. Cattle grazing utilization patterns on these pastures resulted in heavily grazed patches interspersed throughout ungrazed or lightly grazed areas (Ruyle and others 1988). Cattle spent approximately 80 percent of their grazing time feeding in previously grazed patches and only slightly altered this ratio with increasing stocking rates (Abu-Zanat 1986; Nascimento 1988; Ruyle and Rice 1996). Cow biting rates were higher and bite sizes usually smaller when feeding in heavily grazed patches versus lightly grazed areas (Ruyle and others 1987; Ruyle and Rice 1996). Higher nutrient densities and a reduced presence of residual stems in grazed patches were thought to be the primary factors influencing cattle grazing strategies in pastures dominated by Lehmann lovegrass.

Diet Selection—Plant species vary in palatability seasonally and among life forms, and cattle prefer new green forage, shifting their diets in several ways to accommodate this preference (Lister 1938a,b, 1939). Santa Rita researchers observed these differences empirically and experimentally and attempted to use them to control grazing distribution

and use on the various classes of forage (Canfield 1942a; Lister and Canfield 1934; Reynolds and Martin 1968). Most perennial forage grasses were grazed throughout the year. Arizona cottontop was more heavily grazed in the summer, and black grama and bush muhly were grazed most heavily in the winter. Cable and Bohning (1959) were first to demonstrate that the exotic Lehmann lovegrass, introduced from South Africa, was primarily grazed during the spring when it occurred in mixed stands with native perennial grasses.

More exact methods to quantify range cattle diet selection were employed beginning in the early 1960s on the SRER. However, these researchers usually estimated only the crude protein content of diets (Shumway and others 1963). A method to estimate botanical composition of diets from fistulated animals was tested and diet selection results reported in later studies (Galt and others 1968, 1969, 1982). These studies verified earlier results demonstrating that certain species were preferred throughout the year while others were selected seasonally. Summer preference for Arizona cottontop and *Setaria macrostachya* H.B.K. (plains bristlegrass), winter and spring consumption of black grama and Lehmann lovegrass, summer use of slender grama, spring use of Rothrock grama, and winter and summer selection of mesquite and *Calliandra eriophylla* Benth. (false mesquite) were again demonstrated.

Nutrition

Early studies indicated that the primary forage grasses on the SRER did not provide adequate crude protein or phosphorous during the driest times of the year, usually December to February and May and June (Hubber and Cable 1961). These findings were substantiated by later work. Using fistulated animals, researchers demonstrated that steers selected diets much higher in crude protein than hand-clipped samples, although the forage consumed only provided adequate crude protein year around if green, herbaceous growth was available or shrubs made up large portions of the diet (Cable and Shumway 1966; Galt and others 1969; Hayer 1963). While cattle could meet their protein requirements over most of the year by selective grazing, seasonal animal weight changes were caused by seasonal changes in animal requirements (primarily associated with reproduction) and seasonal changes in the quantity and quality of forage (Ward 1975).

Later nutritional studies focused on Lehmann lovegrass as it greatly increased in abundance on much of the SRER (Anable and others 1991). Nutritive values were reported from samples clipped seasonally and from heavily and lightly grazed patches (Abu-Zanat 1989; Osman 1980; Renken 1995). Both crude protein and in vitro dry matter digestibility were higher in Lehmann lovegrass samples from heavily grazed patches than from the adjacent lightly grazed areas (Renken 1995). Diet quality of cows grazing Lehmann lovegrass was also estimated (Ruyle and Rice 1996). Although standing biomass of Lehmann lovegrass is often nutritionally marginal, cattle were able to select green material with adequate crude protein and phosphorous to meet their needs throughout most of the year.

Grazing Distribution

Achieving adequate grazing distribution became an issue as stocking rates were slowly reduced on the SRER. Free-ranging livestock tend to concentrate grazing use near permanent water, resting areas, ridges, bottoms, and areas near trails. Forage utilization levels decrease with increasing distances from these sites (Reynolds and Martin 1968). Range management practices such as watering, salting, supplemental feeding, and fencing were all used on the SRER to improve grazing distribution.

Adding watering places was an early method to promote uniformity of forage use (Culley 1938b). Water hauling was also effective in improving grazing distribution, especially during drought conditions; however, under some situations this practice proved too costly (Bohning 1958a; Reynolds and Martin 1968). Controlling access to water within individual pastures was also used to rotate grazing. Martin and Ward (1970) demonstrated that utilization of perennial grasses near water could be reduced and herbage production increased using this technique.

Providing salt or salt meal was another common method to improve distribution of grazing (Bohning 1958b) albeit with mixed results (Culley 1938b). Placing salt or salt meal on remote parts of the range was found to increase utilization of perennial grasses in those locations, but did not significantly reduce use on areas closer to permanent water (Martin and Ward 1973).

Fencing to improve grazing distribution was also implemented on the SRER, and subdividing large pastures improved livestock handling and forage use patterns, resulting in increased calf crops (Reynolds and Martin 1968).

Stocking Strategies

Conceptual Considerations—From the earliest writings, researchers recognized that if overstocking was the problem, proper stocking was, at least in large part, the solution. As early as 1891, Toumey wrote, “Overfeeding a range has a tendency to kill out better grasses.” He recognized that there were ecological and economic limits to which the range should be stocked and “beyond this limit... will be a detriment to the permanency of the range.” Reducing stocking rates in order to get cattle numbers more in line

with forage production was one of the first orders of business on the SRER (Culley 1937c).

As previously stated, the SRER was destocked from 1903 until about 1914 to allow for some degree of recovery from the extreme overuse suffered under the open range grazing policy for public lands. The SRER was grazed yearlong from 1915 until 1957 when seasonal grazing and grazing system research began.

Over the years a variety of stocking rates have been suggested for semidesert grassland ranges (table 1). Santa Rita researchers and managers recognized declining productivity coupled with a series of drought years and gradually reduced livestock numbers (table 2). Additionally, perceptions of conservative stocking and resulting moderate utilization changed over the years, desired levels of utilization being reduced from about 70 percent (derived from stubble height recommendations found in the archives) to the 40 percent recommended in various publications by Reynolds, Martin, and Cable during the 1960s and 1970s.

Stocking rates on the SRER averaged about 19 acres per Animal Unit Year (AUY) during 1915 until 1925, when they were reduced to about 44 acres per AUY due to historic overuse and declining forage productivity (Cable and Martin 1964). Utilization levels, however, remained high until, in 1956, stocking rates were reduced again in at least four pastures in an attempt to achieve an average 40-percent utilization over species and pastures, which was the stocking objective of the Cable and Martin study (table 2).

Stocking strategies became especially critical during frequent droughts. Experience indicated that each 10-year period brought at least 3 years of critically dry conditions (Canfield 1939). How best to provide continuous yearlong forage for a constant number of livestock became a stocking rate problem. On black grama ranges at the Jornada Experimental Range in southern New Mexico, Canfield (1939) reported that stocking rates of 22 acres per AUY, even though reduced from higher levels at the beginning of the study, were still too high to be maintained in drought years. Conservative stocking levels were recommended that would leave an additional 25 percent of the “useable grass of the average forage crop...ungrazed at the beginning of the new growing season.” Presumably, this adjustment further reduced stocking rates to approximately 29 acres per AUY.

Table 1—Recommended stocking rates for native semidesert grassland in the Southwest.

Stocking rate acres per AUY ^a	Approximate location	Source
37	Semidesert grassland	Griffiths (1904)
50	Santa Rita foothills (approximately 4,000 ft)	Griffiths (1904)
20	Good pasture on Santa Rita Range Reserve	Wooton (1916)
25 to 45	General estimate for semidesert grassland	Ware 1939 (AWP) ^b
22	Black grama range on the Jornada	Canfield (1939)
20	Areas over 4,000 ft on the SRER	Bohning and Martin (1954)
25 to 50	High-elevation pastures on the SRER	Reynolds and Martin (1968)
50 to 100	Mid-elevation pastures on the SRER	Reynolds and Martin (1968)
60 to 160	Low-elevation pastures on the SRER	Reynolds and Martin (1968)

^a Acres per Animal Unit Year.

^b Unpublished document from the Arizona WPA Writer's Project.

Table 2—Actual stocking rates applied to various locations on the Santa Rita Experimental Range (SRER) in southern Arizona.

Stocking rate acres per AU ^a	Years	Approximate location	Source
13.3	1908 to 1914	Averages for Ruelas, Proctor, and MacBeath, early ranchers on the SRER	Wooton 1916
19	1915 to 1925	Average stocking for pastures 1, 7, 8, and 10	Cable and Martin 1964
63	1926 to 1937	Average stocking for entire SRER	Culley 1937?
19	1922 to 1931	Average stocking for “a foothills pasture”	Reynolds 1950
30	1932 to 1941	Average stocking for “a foothills pasture”	Reynolds 1950
44	1941 to 1956	Average stocking for pastures 1, 7, 8, and 10	Cable and Martin 1964
23 to 63	1957 to 1966	Range of stocking for pastures 1, 7, 8, and 10	Cable and Martin 1964
20 to 43	1957 to 1966	Average stocking for pastures 1, 7, 8, and 10	Cable and Martin 1975
120	1957 to 1967	Average stocking for pastures 12B, 3, 2N, 5S, 5N, and 6B	Martin and Cable 1974
45	1972 to 1984	High-elevation, Block 1	Martin and Severson 1988
62	1972 to 1984	Mid-elevation, Block 2	Martin and Severson 1988
141	1972 to 1984	Low-elevation, Block 3	Martin and Severson 1988

^a Acres per Animal Unit Year.

Reynolds (1954) applied this conservative philosophy in his classic discussion of drought and range management based mostly on data from the SRER, collected and organized by Matt Culley. Reynolds compared forage production and stocking rates during three 10-year periods (1922 to 1931, 1932 to 1941, and 1942 to 1951). He characterized drought severity during these periods, respectively, as slight, moderate, and severe. The stocking level was considered conservative during the entire 30-year period, and “was maintained about 20 percent below that which would have been possible based upon average forage production.” Based on a review of records, this stocking strategy probably resulted in an average utilization level of around 60 percent over the 30 years, a little higher during the early years, and a little lower later in the study. This variance was likely due to the diligence with which the stocking levels were actually adjusted. Relying on these long-term records, Reynolds recommended stocking rates that would “use about 40 percent of the average long-term forage production,” but also determined that stocking should be 40 percent below this average about 35 percent of the time “when droughts reach moderate and severe intensity.” In other words, during drought years, reduced production levels would provide less forage for consumption than 40 percent of the long-term average, even at relatively heavy utilization levels. He recognized that livestock operations needed to cull heavily in bad forage years while holding over yearling animals and perhaps purchasing other growing animals during good forage years. The basis of his stocking strategy appears to be aimed at the ability to maintain a base cow herd at a level that reduces the need to heavily destock in drought years.

For their 8-year grazing study in pastures 1, 7, 8, and 10, Cable and Martin (1964) carefully set stocking rates every October based on forage production during the previous summer in an attempt to achieve a 40-percent utilization objective. These calculations, based on Reid and others (1963), resulted in average stocking of 49 acres per AU^a in range units 8 and 10, and 63 acres per AU^a in units 1 and 7. The Reid and others regression approach to stocking requires a history of intensive data on herbage production and utilization, and was developed for stocking experimental pastures. However, in the Cable and Martin (1964) study,

utilization varied yearly from about 30 percent to 65 percent, and use on individual species varied even more widely, even though animal numbers were adjusted annually. Arizona cottontop, plains bristlegrass and, surprisingly, Lehmann lovegrass were used most heavily, while one of the least utilized species was black grama. The high use levels for Lehmann lovegrass likely have less to do with palatability than relative forage abundance; the less abundant species were grazed the most. Overall, utilization levels achieved during this study allowed increases in grass cover over prior years when use was much heavier.

Other records also indicate that species composition of perennial grasses on the SRER has changed since about 1942 as stocking rates were reduced (Reynolds 1956; Rivers and Martin 1980). In 1942, a utilization objective of 50 percent of all the perennial grass herbage was considered conservative. However, actual utilization averaged higher than that between 1942 and 1957 (52, 54, and 58 percent on low-, middle-, and high-elevation pastures). From 1957 until 1966, the utilization objective was lowered to 40 percent of all of the perennial grass herbage, and the Reid and others (1963) basis for adjusting numbers was employed. Utilization “varied markedly” from year to year even though cattle numbers were adjusted each fall (Rivers and Martin 1980). However, over years and all perennial grass species, use at the upper elevation averaged 42 percent, well below the previous years, while use in the middle and lower elevation pastures averaged 49 percent. The more palatable midgrasses increased in composition up to 72 percent during this period.

Practical Considerations—Estimating grazing capacity for a range and making stocking rate adjustments to achieve utilization objectives are largely of conceptual interest; however, developing practical strategies to increase or reduce stocking from one year to the next can have tremendous logistic and economic consequences. Martin (1975c) clearly recognized these practical implications to range management recommendations and, using a plethora of data collected on the SRER, designed a simulation study to analyze “several strategies for coping with year-to-year changes in forage production” focused on ranch income. Records of forage production, utilization, and stocking rates for eight pastures over 29 years were used to compute

“average proper stocking” (based on 40-percent utilization) and to determine the effect of various stocking strategies on cattle sales income at these levels. Stocking rate strategies included constant stocking at 100, 90, and 80 percent of average proper stocking. “Flexible stocking” allowed the number of animal units to fluctuate from 60 to 140 percent of the average proper stocking in accordance with forage production, and “limited flexible stocking” allowed fluctuations of 70 to 110 percent of average.

Under flexible stocking, two plans to reduce stocking were tested for culling in years when forage production was less than the year before. In the first strategy, these management scenarios sold, in order: (1) weaner calves normally held until yearlings, (2) replacement weaner heifers, (3) replacement heifers, and (4) older breeding cows. In the second strategy, old cows were sold first and replacement heifers last. To increase stocking, the scenarios held cows normally culled if the total number of bred cows was low, also held calves normally sold as weaners, and “purchased” additional stocker calves. The highest simulated average net sales resulted from constant stocking at 100 percent of the average level of proper stocking (the highest constant stocking rate tested) followed by net sales under flexible stocking (the flexible rate that allowed increases up to 140 percent of the average). However, Martin understood that the “hazards and high costs of overstocking” also should be considered. The risk of overstocking was evidenced by the fact that these two stocking levels, constant average and the flexible rate with the highest stocking, would result in overstocking almost half the time. The well-documented results of overstocking were manifest in future reduced productivity of perennial forage grasses, facts well known to Martin!

In Martin’s analysis, the relative economic advantage of stocking cows and calves over yearlings depended largely on differences in weight and price per pound between calves and yearlings. Simulations showed that cow-calf units produced more income per animal unit of stocking than cow-yearling units at calf crops of 60 percent or better. Yearlings needed to be held over a full year to ensure they would weigh enough to justify keeping them. However, net sales per 100 animal units in flexible stocking of 120, 130, or 140 percent of average in the best forage years were only \$100 to \$200 greater than for constant stocking at 90 percent of the average proper stocking. Martin was “almost certain that stocking at 90 percent of the average will be more profitable in the long run” than stocking at any higher levels. This stocking rate, 90 percent of the long-term “average proper stocking” (which was calculated at 40-percent utilization) continues to be recommended for semidesert ranges today (Holechek and others 2003). Yet, actual stocking rates higher than these have maintained or improved forage grass stands on the Santa Rita.

Even though SRER researchers attempted to set stocking to achieve specific utilization standards each year, their efforts were surprisingly unsuccessful. Utilization levels varied yearly and by pasture in every long-term grazing study conducted on the SRER. As Martin wrote in 1975a, “stocking rates assume that utilization of perennial grasses over a period of years averages around 40 percent, but may range from as low as 20 percent to as high as 60 percent in individual years.” He went on to say that “the carrying capacity of a range cannot be measured precisely.” Grazing

capacity estimates should be determined “by pasture tests under actual grazing use” (Talbot 1937). As Reynolds and Martin (1968) wrote, “each range should be stocked on its own merits.” Only by stocking and monitoring utilization and plant community responses over time can actual grazing capacities be estimated and adjusted as environmental conditions dictate.

Estimating Utilization

“The key indicator of proper stocking is the intensity of use” (Martin 1975a), so methods to help adjust stocking rates accordingly needed to be developed and tested. The primary expression of stocking levels on range vegetation is “utilization,” defined in 1944 as the degree to which animals have removed the current growth of herbage, expressed in percentage of growth within reach of livestock (Society of American Foresters 1944, as cited in Heady 1945). Measuring and interpreting utilization is “one of the most important phases of range management.”

Humphrey stated in 1938 that during the 22 years (at that time) of regulated grazing on the SRER, “the aim has been to determine proper utilization.” But to do this, the SRER researchers needed a way to improve the accuracy and meaning of utilization estimates. If not conceived on the SRER, the concept of utilization was certainly refined, and field methods were developed and applied as a major research effort there. In this way utilization levels on perennial grasses were estimated to determine stocking pressure.

Specifically, early SRER managers and researchers recognized certain fundamental concepts of utilization. The concepts of proper use, using key species as indicators of utilization on the range as a whole, and the variation in “proper use for a given key species” by range type, soils, and class of stock were summarized by Crafts and Wall in 1938. They clearly realized that “In order that the standards may be properly interpreted and applied, certain fundamental concepts of utilization must be recognized.” They specified that utilization “should be determined at the end of the grazing season,” in other words, fall on seasonal summer ranges and spring on yearlong or seasonal winter ranges.

Parker and Glendening (1942a) defined proper use as “the degree of grazing that will allow the more palatable forage plants to maintain density and vigor, prevent undue runoff and erosion,” and proper use factors, recognized to be “an average for the type” were assigned to individual grass species. Proper use guides varied by range condition with higher levels permissible on ranges in better condition (Crafts 1938b; Parker and Glendening 1942a). Utilization was clearly to be determined “at the end of the grazing year or season” (emphasis in original Parker and Glendening manuscript).

Commonly, the very early observers merely recorded utilization in relation to 100-percent use, and ranges were not considered fully used until “all vegetation was grazed to the ground” (quote from unpublished field notes in SRER archive). However, later researchers soon developed progressively quantitative methods to estimate utilization. In Lister (1938a), “utilization figures represent the percentages grazed of the total plant height” for perennial grasses. Crafts (1938b) recognized that height and volume were not

analogous and developed height-weight relationships for the various forage grasses as “a possible method for measuring volume utilization in the field.” This method was adapted to field procedures using step or line transects by Parker and Glendening (1942b). A utilization gauge was developed to compute the percent of plant volume removed (Lommasson and Jenson 1943; Parker and Glendening 1942b). Pastures were divided into at least two utilization zones for sampling (Parker and Glendening 1942b), and the number of transects required was determined by the relative size of the zone. Utilization was estimated by species, and a weighted average based on the number of plants (called percent composition) was calculated for each zone. Then the percent of proper use was determined by “dividing actual percent use by the calculated percent proper” that was based on proper use factors assigned to each important, grazed species.

Canfield (1942a) proposed the line interception method to estimate utilization (and other “forage-plant inventory” attributes) as a field technique to “insure uniformly good results.” Stubble heights and basal intercepts were recorded on the line, and each stubble height measurement was placed in a stubble height class adapted from Culley (1939) (SRER archives, unpublished data). Measurements were then converted to a weighted average height for each species (Canfield 1944a). A “short-cut” way to apply stubble height estimates was also described by Canfield (1942b, 1944b) for “the field man who has much work to do and little time to do it in.” This procedure estimated only the amount of a grass stand grazed to a stubble height of 2 inches or less. Canfield suggested that a proper utilization level was reached when about 60 percent of the forage grasses had been grazed to a height of 2 inches.

Methods to estimate forage use on the SRER changed over time reflecting more conservative stocking levels and more intensive analysis (table 3). From 1920 to 1938, use was mapped during a general range reconnaissance by “percent of proper use” in seven percentage classes (SRER archives, unpublished field notes): (1) 0 to 30 percent, (2) 35 to 50

percent, (3) 55 to 65 percent, (4) 70 to 80 percent, (5) 85 to 90 percent, (6) 100 percent, (7) greater than 100 percent.

In the 1939 “Utilization survey report on the Santa Rita Experimental Range,” Culley provided nine stubble height classes (table 3) that were combined with a line intercept method to estimate degree of use on individual grass species. This method was used until 1949, differing only slightly the last 3 years of use by locating transects at varying distances from water. In 1950, the method of basing utilization on the percentage of ungrazed plants (Roach 1950) was initiated. This then became the method of choice for most subsequent utilization surveys, including all pasture level grazing studies up to and including Martin and Severson (1988).

Grazing Management and Grazing Systems

Early range scientists commonly recommended some sort of seasonal rest (for example see Sampson 1919), and this was not lost on the Santa Rita researchers. Early research on the SRER, however, focused on reducing stocking rates and the effects of yearlong grazing. Lister and Canfield (1934) studied seasonal differences in cattle selection of grass species and found that different species were preferred in different seasons. Lister (1938b) noted that cattle preferred sideoats grama and Arizona cottontop during the summer, and curly mesquite, black grama, bush muhly, *Bouteloua chondrosioides* (H.B.K.) Benth. Ex S. Wats. (sprucetop grama), and slender grama were preferred during the fall and winter. *Bouteloua hirsute* Lag. (hairy grama) and *Lycurus setosus* (Nutt.) C. Reeder (wolftail) were chosen primarily in the spring. Lister and Canfield concluded, “Seasonal, selective grazing is the natural grazing system.”

To properly stock a range grazed yearlong, this seasonal preference was to be coupled with seasonal production of forage species. Canfield (1938) applied this concept to black grama ranges on the Jornada Experimental Range in a system of grazing he called “semi-deferred.” Semideferred

Table 3—Methods used to estimate utilization of perennial grasses on the Santa Rita Experimental Range in southern Arizona.

Years	Method used	Reference
1920 to 1938	General reconnaissance; use was mapped as percent of “proper use”	Unpublished field notes from archives
1939 to 1946	Line transects to estimate stubble height; these were placed into stubble height classes ^a	Canfield 1942a and b, Culley’s unpublished field notes from archives
1947 to 1949	Same as above except line transects were located at several distances from permanent water	Parker and Glendening 1942b, unpublished field notes from archives
1950 to 1984	Pace transects to estimate the percent of ungrazed plants	Roach 1951

^a Stubble height classes from Culley (1939) (unpublished document in SRER archives).

Class	Stubble height	Comments
1	1/2 inch or less	Very closely used
2	1/2 to 1 inch	Closely used
3	1 to 2 inches	Light overuse
4	2 to 4 inches	Generally conservative use
5	4 to 6 inches	Moderate use
6	6 to 8 inches	Light use
7	8 to 10+ inches	Light to no use
8	Ungrazed	

grazing provided yearlong use but applied “relatively light stocking during the summer grazing season and heavier stocking during fall, winter and spring months.” By regulating stocking in this manner, Canfield concluded, “both summer and winter forage plants receive their just proportions of use.”

Continuous yearlong grazing, however, especially at heavy stocking levels, was well known to alter native grass species composition and reduce forage production on Southwestern ranges (Canfield 1948; Martin 1972). This was especially true near waters with long histories of heavy use. Reducing stocking levels only partly solved this problem because heavy use persisted near permanent water sources. Rotating access to water on the SRER somewhat altered the pattern of heavy use if stocking rates were moderate and the “closed period” included the summer growing season (Martin and Ward 1970).

Under yearlong grazing, proper stocking rates should allow roughly 70 to 80 percent of the current year’s forage to remain after summer use (Lister and Canfield 1934; Talbot 1937). These levels were not the norm on southern Arizona ranges during the first half of the twentieth Century. Utilization surveys on the Santa Rita routinely reported average use well in excess of 70 percent until the 1940s when levels were reduced somewhat (SRER archives, unpublished documents). By this time, experience and empirical evidence conspired to cause reductions in recommended use levels on the SRER. Utilization levels of around 40 to 45 percent on perennial grasses were a common recommendation by mid-1950, however, surveys continued to document average use of over 50 percent on the SRER (SRER archives, unpublished documents). While stocking rates had received considerable attention by mid-century, the effects of grazing at different seasons had not yet been extensively studied in the Southwest.

Data from studies presented at the 1927 Annual Ranger Meeting (SRER archives, unpublished document) indicated that researchers were considering various timings of grazing early in the history of the SRER. Small pasture divisions were protected from grazing during various seasons, and these were compared with “yearlong overgrazing” and “conservative grazing.” It is evident that stocking was to achieve 100-percent use of “average forage production” except under conservative grazing where about 15 percent of the production was left ungrazed (85-percent utilization). Only under conservative yearlong stocking, even at this high level of utilization, did the “palatable forage grasses” make gains in plant density. Thus, level of stocking rather than seasonal rest was believed to be the primary factor preventing loss of forage species.

In later studies, Reynolds (1956) demonstrated similar, if not increased, recovery of cottontop on conservatively stocked pastures grazed yearlong compared to summer-deferred pastures. However, season of use continued to be investigated as a potential grazing management strategy. For example, Cable (1979) found that, over a 15 year period, dormant season grazing, even at high intensities (over 70 percent), had no detrimental influence on Arizona cottontop.

The comparison of seasonal grazing with yearlong grazing on a pasture scale began in earnest in July 1957 with the two 10-year studies, described fully by Martin and Cable (1974) and Cable and Martin (1975). The grazing treatments in the

two studies were the same, November to April, May to October, and yearlong, but stocking was much heavier as described by Martin and Cable (table 2). The intent was to stock the seasonally grazed pastures at the same rate as the yearlong pastures, hence the number of animals were doubled in the seasonal units. As has proved the norm in large-scale grazing studies, weather was a dominant influence on vegetation responses. Additionally, initial plant community differences (perennial grass basal cover) among pastures persisted throughout the study. Although Cable and Martin (1964) concluded “moderate utilization of the perennial grasses combined with alternate-summer deferment of grazing resulted in marked range improvement,” and Reynolds and Martin (1968) reported seasonal deferment benefits were “evident in the preliminary results,” the 1974 analyses stated that such deferment “had no apparent beneficial effect,” and the 1975 paper stated “alternate-year summer deferment did not improve perennial grass production.”

Seasonal grazing did not result in improved animal or vegetation conditions when compared to yearlong grazing, perhaps partly due to more concentrated use limiting diet selection and somewhat higher utilization levels in the seasonally grazed pastures. Calf weights reported by Martin and Cable (1974) averaged somewhat higher from pastures grazed yearlong (415 pounds versus 396 pounds) and were significantly higher from the higher elevation pastures (446 pounds versus 365 pounds). These researchers continued to ponder the importance of seasonal rest, however, and several important hypotheses came from this study.

Martin and Cable determined that the November to April grazing treatment was not entirely a dormant season of grazing, but included a critical period of spring growth (February to April). Even though perennial semidesert grasses produce little growth during that period, it is the time when basal buds “break dormancy to initiate the culms that produce forage the following summer” (Cable 1975; Martin and Cable 1974). These researchers suspected that spring grazing was detrimental to forage production in the following summer, and this became the basis for further clipping studies (Martin 1973a) and, eventually, the foundation for the Santa Rita Grazing System (Martin 1973b; Martin and Severson 1988).

To more fully test this hypothesis, Martin (1973a) designed a series of small plot (20-ft square) grazing treatments to simulate 15 “rest-grazing schedules.” He accomplished these treatments during an 8-year study by rotating a series of panels to exclude grazing during certain periods at locations on “overgrazed range near permanent water” (Martin and Ward 1976). Due to such a location, average utilization was heavy, as high as 70 percent on plots that had been grazed continuously for the preceding 12 months or that had been rested in winter only. Of all the treatments tested, March through October rest, two years in three, resulted in greatest total perennial grass production. Grass densities were also highest in these plots, but not significantly greater than those with other combinations of rest.

Several of these alternate year seasonal rest treatments were compared in three different pastures in the Martin and Ward (1976) study. Seasons of rest were spring (March through June), summer (July through October), and winter (November through February), and were applied in various combinations using similar 20-ft-square enclosures as the

earlier study. Perennial grass production was the measure of effectiveness and varied greatly among sites and years during the 7-year study. This variability masked any effects of the rest schedules on perennial grass production; however, March through October rest in alternate years was the best of the six treatments at two of the three sites in the experiment. This gave the researchers some hope that these results supported the earlier study, but they also suggested that perennial grass production might be too variable an attribute to test trends in "short term grazing studies" (Martin and Ward 1976).

From these studies and others, Martin (1973b, 1978b) proposed the three-pasture grazing system that became known as the Santa Rita Grazing System (table 4). The system was tested experimentally on the SRER at a pasture scale from 1972 to 1984 (Martin and Severson 1988). Study treatments included both a continuous yearlong treatment and the Santa Rita Grazing System, and were blocked by elevation roughly corresponding to the foothill, mesa, and transition units recognized by Canfield (1948) and Reynolds (1954). Utilization and densities of perennial grasses and canopy cover of shrubs were measured at two distances from water. Standing crop estimates were also determined each fall. Utilization was estimated by the ungrazed plant method (Roach 1950) and averaged about 50 percent for all treatments.

Plant densities and production varied in response to precipitation and elevation each year, but did not show measured positive responses to the grazing treatments. The pasture level study failed to duplicate the results of the previous small plot studies. Again, the researchers justified this nonresponse by citing site-specific variability in overall range conditions at the beginning of the study (higher densities of perennial grasses than the earlier study), relatively low grazing intensity, and climatic variability. Undaunted, Clark continued to fully believe and was not hesitant to write that 2 consecutive years of March through October rest should be included in semidesert grassland grazing systems (Martin 1975a).

In the early 1980s, a short-duration grazing system was briefly implemented, with a radial spoke fence design, where pasture fences radiate from a common water source. The demonstration never received the management attention necessary and was soon abandoned as a project.

Data Contingencies and Research Gaps

The Santa Rita researchers recognized there were limitations to their research imposed by the range itself.

System-level influences were manifested in the results from most grazing studies on the SRER and continue to cloud the interpretation of these studies today. Soils and precipitation regimes were known to influence the potential for recovery from overgrazing and the ability of the vegetation to withstand grazing, concepts that became known as resilience and resistance. Researchers discovered early on that the elevational position on the SRER was directly related to precipitation and vegetation potential. Canfield (1948) and Reynolds (1954) organized this gradient into three units, the foothill unit (4,000 to 5,000 ft), the mesa unit (3,000 to 4,000 ft), and the transition unit (below 3,000 ft). Most subsequent grazing studies used similar distinctions as blocks in experimental designs.

The amount of precipitation received during a particular study was often the overriding influence on vegetation responses. Additionally, they learned that the plant community present at the beginning of a study also influenced the effects of the grazing treatments imposed. The Martin and Cable study (1974) began after the extremely dry seasons in 1956–1957, which undoubtedly influenced vegetation at the beginning of the study and, later, the subsequent treatment effects. Conservative stocking and seasonal grazing treatments were more likely to improve degraded plant communities, which were near water or in other areas of historically heavy grazing, than those communities less impacted by grazing. Species such as Rothrock grama and various three-awn grasses consistently increased in density and productivity in response to seasonal rest, while other grasses did not. The current shift to Lehmann lovegrass as the dominant grass in some pastures has no doubt changed potential ecosystem responses to grazing. Such factors continue to confound landscape-level grazing studies, even those designed as experiments with replicated pastures. Smaller plot, controlled studies have become the standard for rangeland research. The value of large studies should not be disregarded, however, and the SRER approach of combining small plots and pasture-level treatments is relevant today.

There are four areas of grazing effects that were not studied at the SRER and continue to be gaps in knowledge that limit science-based management of Southwestern rangelands. These are (1) riparian grazing, (2) combined prescribed burning and grazing, (3) the impacts of grazing on soils, and (4) grazing effects on endangered species. There is little or no riparian vegetation on the SRER, hence there was no opportunity to investigate this area. The impact of livestock grazing on endangered species has only recently achieved recognition as an important research topic. The SRER offers a particularly unique opportunity to investigate the influences of grazing on the *Corypantha scherrivar*.

Table 4—Suggested grazing and rest schedules for the three-pasture Santa Rita grazing system (Martin 1973a).

	Year 1			Year 2			Year 3		
	November to February	March to June	July to October	November to February	March to June	July to October	November to February	March to June	July to October
Pasture 1	Rest	Graze	Graze	Rest	Rest	Rest	Graze	Rest	Rest
Pasture 2	Graze	Rest	Rest	Rest	Graze	Graze	Rest	Rest	Rest
Pasture 3	Rest	Rest	Rest	Graze	Rest	Rest	Rest	Graze	Graze

robustinspina (Schott & Engelmenn) L. Benson (Pima pineapple cactus), listed as an endangered plant species.

Fire and grazing regimes were discussed for years, but never actually applied to research designs due to logistic and other practical reasons. In addition, the limited amount of soils research is unusual. As described previously, the early observers recognized that the native bunchgrasses formed no sod, leaving the soil subject to trampling damage. Similarly, the presence of "washed soils" was recognized (Griffiths 1901). These conditions presumably resulted in reduced recovery and productive capacities compared to intact or undisturbed soils, but such research was not forthcoming.

Future Research Direction

Over 25 years ago, Martin (1975a) recommended shifting research emphasis from livestock production to using livestock as a tool to manage the range for stated objectives. He also recognized the emerging importance of open space and recreational opportunities and resource use demands from an increasingly urban population. These research shifts have never really occurred, yet the need for such information remains critical.

The past has certainly set the stage for future range livestock grazing research on the SRER. Existing, long-term data sets are available for careful analysis of grazing pressure gradients, including information from protected areas. Large, pasture-scale grazing treatments should be continued, but with a more integrated approach to range livestock production that considers vegetation and soil response, ranch management requirements and economics, and the role of ranching in planning and regulating urban growth. Reductions in the number of treatments and herds to consolidate resources, a re-examination of stocking rates, as well as the reinstatement of some of the traditional management practices should be considered, including adjusting animal numbers each fall, estimating annual utilization, and keeping a record of individual animal production. The potential for producing and marketing natural beef should also be investigated. In addition, landscape-level analyses to address questions about the sustainability of range livestock grazing in terms of nutrient flows, site potential, and watershed processes remain a priority.

Summary and Major Contributions

Research on the Santa Rita developed the concepts, methods, and tools to manage range livestock conservatively and therefore sustainably. The studies conducted and experience gained on the SRER provided the philosophy and working foundation for the Federal regulation of range livestock management in the Southwest, especially by the Forest Service. The research demonstrated that, if weather conditions are at all favorable and mesquite overstory is not a constraint, rangelands could recover from the effects of overgrazing and even improve while being conservatively grazed. Measurements of recovery included densities and

productivity of palatable, native perennial grasses. In addition to precipitation and site potential, heavy stocking rates were identified as drivers of ecological range condition and livestock performance.

Seasonal rest, while considered important, actually proved to be of secondary value. However, spring through summer rest, for two years out of three was a deferred grazing system that was recommended and demonstrated, most convincingly in small plots, to improve overgrazed vegetation. Using this strategy in larger pastures, the most improvement that was measured was in species such as Rothrock grama and three-awn grasses rather than such midgrasses as Arizona cottontop and sideoats grama. Empirical observations, however, indicate that these plants also benefit from seasonal rest.

Recommended stocking rates for semidesert grasslands developed from SRER research were approximately 90 percent of average proper stocking based on 40-percent utilization, calculated from a running 10-year average forage production. It is interesting that, based on utilization surveys in the SRER archives, these recommended use levels never seemed to be achieved. Such conservative stocking recommendations appear to be made in order to reduce extremely heavy grazing in low forage production years and allow the maintenance of a relatively stable base cow herd over the long term. Of course, where Lehmann lovegrass now dominates the herbaceous plant community, higher stocking rates appear to be possible.

Utilization guidelines were shown to be just that, guidelines, and were never achieved every year. Many processes combined to produce variability in utilization estimates. Diet preference influenced degree of use on individual plant species, and grazing pressure varied over time and space resulting in uneven utilization patterns. Utilization levels were consistently inversely proportional to forage production even when livestock numbers were reduced to compensate for years with low precipitation. To provide some uniformity to the concept, utilization was estimated after the grazing season or in June on yearlong ranges, at several distances from water, and averaged over species, pasture, and year.

After grazing resumed in 1914, the SRER was never completely destocked, even during times of drought or in periods of drought recovery. In fact it was thought by some that ranges recovered more quickly under conservative grazing than when completely protected from grazing. SRER researchers recognized drought as a stocking rate problem and adjusted livestock numbers as necessary to accommodate reduced forage and to protect against ecological deterioration.

In conclusion, the concepts, principles, and practices developed on the SRER continue to be applied by range managers today. Much more is now known, of course, about plant physiological responses to grazing, animal behavior, and vegetation dynamics. However, it still behooves current range managers to integrate the lessons of the past with the knowledge of today as they continue the quest for sustainable rangeland livestock production that began on the Santa Rita Experimental Range.

References

- Abu-Zanat, Mahfouz. 1989. Ingestive behavior of cattle grazing in lightly and heavily grazed patches of Lehmann lovegrass (*Eragrostis lehmanniana* Nees). Tucson: University of Arizona. 98 p. Dissertation.
- Allen, Larry S. 1989. Roots of the Arizona livestock industry. *Rangelands*. 11: 9–13.
- Anable, M. E.; McClaran, M. P.; Ruyle, G. B. 1991. Spread of introduced Lehmann lovegrass in southern Arizona, U.S.A. *Biological Conservation*. 61: 181–188.
- Bohning, John W. 1958a. Who can afford to haul water? *The American Hereford Journal*. 49: 656–657.
- Bohning, John W. 1958b. Salting for better livestock distribution. *Arizona Cattlelog*. 13: 60–61.
- Cable, Dwight R. 1975. Influence of precipitation on perennial grass production in the semidesert Southwest. *Ecology*. 56: 981–986.
- Cable, Dwight R. 1979. Ecology of Arizona cottontop. Res. Pap. RM-209. Fort Collins, CO: U.S. Department of Agriculture, Forest Service, Rocky Mountain Forest and Range Experiment Station. 21 p.
- Cable, Dwight R.; Bohning, John W. 1959. Changes in grazing use and herbage moisture content of three exotic lovegrasses and some native grasses. *Journal of Range Management*. 12(4): 200–203.
- Cable, Dwight R.; Martin, S. Clark. 1964. Forage production and stocking rates on southern Arizona ranges can be improved. Fort Collins, CO: U.S. Department of Agriculture, Forest Service, Rocky Mountain Forest and Range Experiment Station. 11 p.
- Cable, Dwight R.; Martin, S. Clark. 1975. Vegetation responses to grazing, rainfall, site condition, and mesquite control on semidesert range. Fort Collins, CO: U.S. Department of Agriculture, Forest Service, Rocky Mountain Forest and Range Experiment Station. 24 p.
- Cable, Dwight R.; Shumway, R. Phil. 1966. Crude protein in rumen contents and in forage. *Journal of Range Management*. 19(3): 124–128.
- Canfield, R. H. 1938. Vegetational density and composition of black grama type ranges as influenced by semi-deferred grazing. Res. Note 35. Tucson, AZ: U.S. Department of Agriculture, Forest Service, Southwestern Forest and Range Experiment Station. 2 p.
- Canfield, R. H. 1939. Ways and means to minimize the ill effects of drought on black grama ranges. Res. Note 82. Tucson, AZ: U.S. Department of Agriculture, Forest Service, Southwestern Forest and Range Experiment Station. 7 p.
- Canfield, R. H. 1942a. The relative grazing preference of cattle for the common semidesert grasses in southern Arizona. Tucson, AZ: U.S. Department of Agriculture, Forest Service, Southwestern Forest and Range Experiment Station. 3 p.
- Canfield, R. H. 1942b. Sampling ranges by the line interception method: plant cover, composition, density, degree of forage use. Tucson, AZ: U.S. Department of Agriculture, Forest Service, Southwestern Forest and Range Experiment Station. 28 p.
- Canfield, R. H. 1942c. A short-cut method for estimating grazing use. Tucson, AZ: U.S. Department of Agriculture, Forest Service, Southwestern Forest and Range Experiment Station. 5 p.
- Canfield, R. H. 1944a. Measurement of grazing use by the line interception method. *Journal of Forestry*. 42(3): 192–194.
- Canfield, R. H. 1944b. A short-cut method for checking degree of forage utilization. *Journal of Forestry*. 42(4): 192–194.
- Canfield, R. H. 1948. Perennial grass composition as an indicator of condition of Southwestern mixed grass ranges. *Ecology*. 29(2): 190–204.
- Caraher, David L. 1970. Effects of longtime livestock exclusion versus grazing on the desert grassland of Arizona. Tucson: University of Arizona. 45 p. Thesis.
- Crafts, Edward C. 1937. Proper utilization of bunchgrass range. Res. Note 12. Tucson, AZ: U.S. Department of Agriculture, Forest Service, Southwestern Forest and Range Experiment Station. 3 p.
- Crafts, Edward C. 1938a. Experimental ranges and other range research centers of the Forest Service. Tucson, AZ: U.S. Department of Agriculture, Forest Service, Southwestern Forest and Range Experiment Station. 15 p.
- Crafts, Edward C. 1938b. Height-volume distribution in range grasses. *Journal of Forestry*. 36(12): 1182–1185.
- Crafts, Edward C.; Glendening, George E. 1942. How to graze blue grama on Southwestern ranges. Leaflet 215. Washington, DC: U.S. Department of Agriculture. 8 p.
- Crafts, Edward C.; Wall, Lloyd A. 1938. Tentative range utilization standards. Res. Note 25. Tucson, AZ: U.S. Department of Agriculture, Forest Service, Southwestern Forest and Range Experiment Station. 3 p.
- Culley, Mathew J. 1937a. An economic study of cattle business on a Southwestern semidesert range. Washington, DC: U.S. Department of Agriculture. 24 p.
- Culley, Mathew J. 1937b. Grazing habits of range cattle. Tucson, AZ: U.S. Department of Agriculture, Forest Service, Southwestern Forest and Range Experiment Station. 4 p.
- Culley, Mathew J. 1937c. How to get sustained forage production in grazing semidesert mixed grass ranges. *Western Livestock Journal*. 15(23): 5–6.
- Culley, Mathew J. 1938a. Grazing habits of range cattle. *The Cattleman*. 24: 19–23.
- Culley, Mathew J. 1938b. Planning for range improvements. *American Cattle Producer*. 20(3): 3–4.
- Culley, Mathew J. 1938c. Grazing habits of range cattle. *American Cattle Producer*. 20(1): 3, 4, 16, 17.
- Culley, Mathew J. 1941. Does it rain less now than in the old days? *Western Livestock Journal*. 19(44): 5, 78.
- Culley, Mathew J. 1942. Thirty years ago and now in Arizona cattledom. *Western Livestock Journal*. 28(2): 43.
- Culley, Mathew J. 1943. Proper stocking pays dividends. *Western Livestock Journal*. 28(1): 7.
- Culley, Mathew J. 1946a. Factors affecting range calf crop. *Arizona Stockman*. 12(10): 30–37.
- Culley, Mathew J. 1946b. Good range cattle. *Arizona Cattlelog*. 1(10, 11): 3–6, 12–14.
- Culley, Mathew J. 1946c. Quality cattle for profit. *American Hereford Journal*. 37(11): 8–9, 168–169.
- Culley, Mathew J. 1947. It pays to be loss conscious. *The Cattleman*. 34(7): 25–26, 52, 55.
- Culley, Mathew J. 1948. Modern business methods in handling range cattle. *Arizona Stockman*. 14(4): 13, 26–27.
- Culley, Mathew J.; Campbell, R. S.; Canfield, R. H. 1933. Values and limitations of clipped quadrats. *Ecology*. 14(1): 35–39.
- Galt, H. D.; Ogden, Phil R.; Ehrenreich, J. H.; Theurer, Brent; Martin, S. Clark. 1968. Estimating botanical composition of forage samples from fistulated steers by a microscope point method. *Journal of Range Management*. 21(6): 397–401.
- Galt, H. D.; Theurer, Brent; Ehrenreich, J. H.; Hale, W. H.; Martin, S. Clark. 1969. Botanical composition of diet of steers grazing a desert grassland range. *Journal of Range Management*. 22(1): 14–19.
- Galt, H. D.; Theurer, Brent; Martin, S. Clark. 1982. Botanical composition of steer diets on mesquite and mesquite-free desert grassland. *Journal of Range Management*. 35(3): 320–325.
- Gamougoun, Ngartoina D. 1987. Cattle grazing behavior and range plant dynamics in southern Arizona. Tucson: University of Arizona. 235 p. Dissertation.
- Glendening, George E. 1952. Some quantitative data on the increase of mesquite and cactus on a desert grassland range in southern Arizona. *Ecology*. 33(3): 319–328.
- Gomes, Hilton de Souza. 1983. Forage preference and grazing behavior of Hereford and Barzona cattle on southern Arizona range. Tucson: University of Arizona. 52 p. Thesis.
- Griffiths, David. 1901. Range improvement in Arizona. Washington, DC: U.S. Department of Agriculture, Bureau of Plant Industry. 31 p.
- Griffiths, David. 1904. Range investigations in Arizona. Washington, DC: U.S. Department of Agriculture, Bureau of Plant Industry. 62 p.
- Griffiths, David. 1910. A protected stock range in Arizona. Washington, DC: U.S. Department of Agriculture. 28 p.
- Hayer, William T. III. 1963. Seasonal influences on the grazing ruminant's diet and rumen function. Tucson: University of Arizona. 35 p.

- Heady, Harold F. 1945. Methods of determining utilization of range forage. *Journal of Range Management*. 45: 53–63.
- Holechek, Jerry; Dee Galt, Henry; Joseph, Jamus; Navaroo, Joseph; Kumalo, Godfrey; Molinar, Francisco; Thomas, Milt. 2003. Moderate and light cattle grazing effects on Chihuahuan desert rangelands. *Journal of Range Management*. 56(20): 133–139.
- Huber, Farris, Jr.; Cable, Dwight R. 1956. Qualitative evaluation of range forage in southern Arizona. Unpublished manuscript on file at: Santa Rita Experimental Range Archives, University of Arizona, Tucson, AZ.
- Humphrey, Robert R. 1938. Burroweed in relation to grass cover and grazing. *Arizona Stockman*. March: 12, 14.
- Lister, Paul B. 1938a. How utilization of forage plants varies by seasons on semidesert grasslands. Tucson, AZ: U.S. Department of Agriculture, Forest Service, Southwestern Forest and Range Experiment Station. 3 p.
- Lister, Paul B. 1938b. Seasonal utilization of forage plants. *The Cattleman*. August 25: 29–30.
- Lister, P. B. 1939. Forage plant utilization varies by seasons on semi-desert lands. *Arizona Stockman*. August: 10–11.
- Lister, P. B.; Canfield, R. H. 1934. Seasonal selective use of Southwestern range grasses by cattle. Unpublished manuscript on file at: Santa Rita Experimental Range Archives, University of Arizona, Tucson, AZ.
- Lommasson, T.; Jensen, Chandler. 1943. Determining the utilization of range grasses from height-weight tables. *Journal of Forestry*. 41(8): 589–593.
- Martin, S. Clark. 1943. Grass makes beef. *American Hereford Journal*. 34(4): 308, 320.
- Martin, S. Clark. 1972. Some effects of continuous grazing on forage production. *Arizona Cattlelog*. 28(10): 17, 18, 23–25.
- Martin, S. Clark. 1973a. Responses of semidesert grasses to seasonal rest. *Journal of Range Management*. 26(3): 165–170.
- Martin, S. Clark. 1973b. A grazing system for semidesert ranges based on responses of grasses to seasonal rest. In: 26th annual meeting, Society for Range Management: abstracts of papers; 1973 February; Boise, ID. Denver, CO. Society for Range Management: 21 p.
- Martin, S. Clark. 1975a. Ecology and management of Southwestern semidesert grass-shrub ranges: the status of our knowledge. Res. Pap. RM-156. Fort Collins, CO: U.S. Department of Agriculture, Forest Service, Rocky Mountain Forest and Range Experiment Station. 39 p.
- Martin, S. Clark. 1975b. Why graze semidesert ranges? *Journal of Soil and Water Conservation*. 30(4): 186–188.
- Martin, S. Clark. 1975c. Stocking strategies and net cattle sales on semidesert range. Res. Pap. RM-146. Fort Collins, CO: U.S. Department of Agriculture, Forest Service, Rocky Mountain Forest and Range Experiment Station. 10 p.
- Martin, S. Clark. 1978a. Grazing systems—what can they accomplish? *Rangeman's Journal*. 5(1): 14–16.
- Martin, S. Clark. 1978b. The Santa Rita grazing system. In: Hyder, Donald N., ed. *First International Rangelands Congress: proceedings*; 1978 August 14–18; Denver, CO. Society for Range Management: 573–575.
- Martin, S. Clark. 1987. Converting forage to food with cattle on the Santa Rita Experimental Range. In: Aldon and others, tech coords. *Strategies for classification and management of native vegetation for food production in arid zones*. Fort Collins, CO: U.S. Department of Agriculture, Forest Service: 179–181.
- Martin, S. Clark; Cable, Dwight R. 1974. Managing semidesert grass-shrub ranges: vegetation responses to precipitation, grazing, soil texture, and mesquite control. Fort Collins, CO: U.S. Department of Agriculture, Forest Service, Rocky Mountain Forest and Range Experiment Station. 45 p.
- Martin, S. Clark; Reynolds, Hudson G. 1973. The Santa Rita Experimental Range: your facility for research on semidesert ecosystems. *Journal of the Arizona Academy of Science*. 8: 56–67.
- Martin, S. Clark; Severson, Keith E. 1988. Vegetation response to the Santa Rita grazing system. *Journal of Range Management*. 41(4): 291–295.
- Martin, S. Clark; Ward, Donald E. 1970. Rotating access to water to improve semidesert cattle range near water. *Journal of Range Management*. 23(1): 22–26.
- Martin, S. Clark; Ward, Donald E. 1973. Salt and meal-salt help distribute cattle use on semidesert range. *Journal of Range Management*. 26(2): 94–97.
- Martin, S. Clark; Ward, Donald E. 1976. Perennial grasses respond inconsistently to alternate year seasonal rest. *Journal of Range Management*. 29(4): 346.
- Nascimento, Hoston T. S. 1988. Pattern of utilization and response of Lehmann lovegrass (*Eragrostis lehmanniana* Nees) grazed by cattle. Tucson: University of Arizona. 195 p. Dissertation.
- Osman, Mohamoud A. 1982. Chemical composition and digestibility of Lehmann lovegrass (*Eragrostis lehmanniana*) in response to grazing and clipping intensities. Tucson: University of Arizona. 67 p. Thesis.
- Parker, Kenneth W. 1939. Management of livestock to avoid losses from poisonous plants. Tucson, AZ: U.S. Department of Agriculture, Forest Service, Southwestern Forest and Range Experiment Station. 4 p.
- Parker, Kenneth W. 1942. A method for estimating grazing use in mixed grass types. Tucson, AZ: U.S. Department of Agriculture, Forest Service, Southwestern Forest and Range Experiment Station. 5 p.
- Parker, Kenneth W. 1943. Market'em when they're ready. *The Cattleman*. 30(4): 96, 98.
- Parker, Kenneth W. 1944. Adjust range stocking for heavier animals. *The Cattleman*. 31(3): 17, 18, 38, 39.
- Parker, Kenneth W; Glendening, George E. 1942a. General guide to satisfactory utilization of the principal Southwestern range grasses. Res. Note 104. Tucson, AZ: U.S. Department of Agriculture, Forest Service, Southwestern Forest and Range Experiment Station. 4 p.
- Parker, Kenneth W; Glendening, George E. 1942b. A method for estimating grazing use in mixed grass types. Res. Note 105. Tucson, AZ: U.S. Department of Agriculture, Forest Service, Southwestern Forest and Range Experiment Station. 5 p.
- Reid, Elbert H.; Kovner, Jacob L.; Martin, S. Clark. 1963. A proposed method of determining cattle numbers in range experiments. *Journal of Range Management*. 16(4): 184–187.
- Renken, Wilma Jean. 1995. In-vitro dry matter digestibility of Lehmann lovegrass (*Eragrostis lehmanniana* Nees) within grazed patches and lightly grazed areas. Tucson: University of Arizona. 64 p. Thesis.
- Reynolds, Hudson G. 1954. Meeting drought on southern Arizona rangelands. *Journal of Range Management*. 7(1): 33–40.
- Reynolds, Hudson G. 1956. Managing grass-shrub cattle ranges in the Southwest. Washington, DC: U.S. Department of Agriculture. 40 p.
- Reynolds, Hudson G.; Martin, S. Clark. 1968. Managing grass-shrub cattle ranges in the Southwest. Washington, DC: U.S. Department of Agriculture. 44 p.
- Rivers, William J.; Martin, S. Clark. 1980. Perennial grass improves with moderate stocking. *Rangelands*. 2(3): 105–106.
- Roach, Mack E. 1950. Estimating perennial grass utilization on semidesert cattle ranges by percentage of ungrazed plants. *Journal of Range Management*. 3(3): 182–185.
- Ruyle, G. B.; Hasson, Oren; Rice, R. W. 1987. The influence of residual stems on the biting rates of cattle grazing *Eragrostis lehmanniana* Nees. *Applied Animal Behavior Science*. 19: 11–17.
- Ruyle, G. B.; Ogden, P. R.; Rice, R. W. 1988. Defoliation patterns of cattle grazing Lehmann lovegrass. *Applied Agricultural Research*. 3(4): 177–181.
- Ruyle, George B.; Rice, Richard W. 1996. Aspects of forage availability and short-term intake influencing range livestock production. In: Judkins, M. B.; McCollum, F. T., eds. *Proceedings, grazing livestock nutrition conference*. Vol. 47, Sup. 1, Western Section American Society of Animal Science: 40–50.
- Ruyle, G. B.; Tronstad, Russell; Hadley, D. W.; Heilman, Phillip; King, D. A. 2000. Aspects of cattle ranching in Arizona. In: Jemison, R.; Raish, C.; Finch, D., eds. *Ecological, cultural, and socioeconomic aspects of livestock management in the Southwest*. Elsevier Science Press: 379–417.
- Sampson, A. W. 1919. Plant succession in relation to range management. Bull. 791. U.S. Department of Agriculture.
- Sheridan, Thomas E. 1995. *Arizona, a history*. Tucson: University of Arizona Press. 434 p.

- Shumway, R. Phil; Hubbert, Farris, Jr.; Hayer, W. T., III; Cable, Dwight R.; Hale, W. H. 1963. A qualitative determination of the diet of grazing steers under desert grassland conditions. In: Western Section American Society of Animal Science: proceedings; 1963 August; Corvallis, OR: 14(38): 1-6.
- Talbot, M. W. 1937. Indicators of Southwestern range conditions. Farmers Bull. 1782. U.S. Department of Agriculture. 35 p.
- Taylor, Walter P. 1930. Methods of determining rodent pressure on the range. Ecology. 11(3): 523-542.
- Taylor, Walter P.; Vorhies, Charles T.; Lister, P. B. 1935. The relation of jack rabbits to grazing in southern Arizona. Journal of Forestry. 33(5): 490-498.
- Thorner, J. J. 1910. The grazing ranges of Arizona. Tucson: University of Arizona, Agricultural Experiment Station. 360 p.
- Toumey, J. W. 1891. Notes on some of the range grasses of Arizona. In: Overstocking the range. Tucson: University of Arizona, Agriculture Experiment Station. 8 p.
- Ward, Donald E. 1975. Seasonal weight changes of cattle on semi-desert grass-shrub ranges. Journal of Range Management. 28(2): 97-99.
- Wooten, E. O. 1916. Carrying capacity of grazing ranges in southern Arizona. Washington, DC: U.S. Department of Agriculture. 40 p.
- Zemo, Tesfay; Klemmedson, James O. 1970. Behavior of fistulated steers on a desert grassland. Journal of Range Management. 23(2): 158-163.

Vegetation Management Practices: Past and Present

Abstract: Improving management practices have been at the core of most research conducted in the semidesert grass-shrub vegetation on the Santa Rita Experimental Range. Much of this research has been directed to sustaining forage resources through proper livestock grazing and controlling the invasion of competing woody plants, primarily mesquite. Both research orientations require an understanding of the basic ecological requirements and dynamics of the plant species on the Experimental Range. Cattle grazing system based on seasonal grazing and periodic rest periods have been able to improve the production and diversity of native perennial grasses. Several methods have been successful in controlling the occurrence of mesquite and improving forage production, although there is a growing acknowledgment that mesquite has a place on the landscape. Research emphasis on the Santa Rita Experimental Range in the future is likely to be placed more on evaluating the effectiveness of ecosystem-based, multiple-use vegetation management practices that are ecologically sustainable and environmentally sound.

Keywords: semidesert rangelands, grass-shrub vegetation

Acknowledgments: The authors gratefully acknowledge the reviews of this paper by Warren P. Clary, Project Leader, USDA Forest Service (retired), Boise, ID, and Alejandro Castellanos, Professor, University of Sonora, Hermosillo, Sonora, Mexico.

Introduction

Semidesert grass-shrub vegetation is the characteristic plant cover of the Santa Rita Experimental Range. This vegetation is similar to that occupying extensive acreage in the Southwestern United States, although its actual coverage is difficult to quantify because of the historical and, to some extent, continuing invasion of woody vegetation onto adjacent grasslands. Semidesert grass-shrub vegetation is found between 3,000 and 5,000 ft (900 and 1,500 m) elevation within a strip 50 to 100 miles (80 to 160 km) wide along the southern boundaries of Arizona, New Mexico, and western Texas (Martin 1975). The vegetation below 3,000 ft (900 m) consists mainly of desert shrubs, while the vegetation above 5,000 ft (1,500 m) is chaparral, pinyon-juniper or oak woodlands, or (on occasion) grassland. Vegetation on the Santa Rita Experimental Range is largely a microcosm of that found on semidesert grass-shrub rangelands throughout the Southwestern United States.

Forage components on Southwestern semidesert grass-shrub vegetation have supported a livestock industry in the Southwest since 1850 (Herbel 1979; Martin 1975; McPherson 1997; Sayre 1999), while the small trees have historically been cut by local people for firewood, poles, posts, and corral rails (Conner and others 1990; Ffolliott 1999; Martin 1986.). However, the primary land-use concern on these rangelands is no longer to simply graze livestock or occasionally cut trees for local use. The emphasis in the future will likely be placed more on evaluating the effectiveness of ecosystem-based, multiple-use management practices that are ecologically sustainable and environmentally sound.

A review of past and present vegetation management practices on the Santa Rita Experimental Range and other semidesert grass-shrub rangelands in the Southwestern United States is presented in this paper to show how the management emphasis has changed through time and is likely to continue to change into the future. The literature forming the basis of this review is not intended to be all inclusive, but rather it is representative of the historical knowledge base obtained on the Santa Rita Experimental Range and other Southwestern semidesert grass-shrub rangelands.

Peter F. Ffolliott is Professor, School of Renewable Natural Resources, 325 Biological Sciences East, University of Arizona, Tucson, AZ 85721; e-mail: ffolpete@ag.arizona.edu. Gerald J. Gottfried is Research Forester, Rocky Mountain Research Station, USDA Forest Service, Phoenix, AZ. William H. Kruse is Range Scientist, Rocky Mountain Research Station, USDA Forest Service (retired), Flagstaff, AZ.

In: McClaran, Mitchel P.; Ffolliott, Peter F.; Edminster, Carleton B., tech. coords. Santa Rita Experimental Range: 100 years (1903 to 2003) of accomplishments and contributions; conference proceedings; 2003 October 30–November 1; Tucson, AZ. Proc. RMRS-P-30. Ogden, UT: U.S. Department of Agriculture, Forest Service, Rocky Mountain Research Station.

Vegetation Resources

The diversity of vegetation that is characteristic of semi-desert grass-shrub rangelands is also found on the Santa Rita Experimental Range (Humphrey 1953; Humphrey and Mehrhoff 1958; Martin 1966, 1975, 1986a; Medina 1996; Severson and Medina 1981). Herbaceous plants include a variety of perennial grasses, forbs, and succulents. Annual plants spring forth following rainfall events that are favorable to their germination. Woody vegetation on these rangelands is dominated by small trees and medium to large shrubs that are often a detriment to sustaining vigorous stands of forage plants but can have value in themselves.

Herbaceous Vegetation

The composition and relative abundance of perennial grasses on the Santa Rita Experimental Range change with elevation and, therefore, temperature regimes and precipitation amounts. Tall threeawns (*Aristida hamulosa* and *A. ternipes*) are commonly found at all elevations. Santa Rita threeawn (*A. glabrata*) and Rothrock grama (*Bouteloua rothrockii*) are the major species in the middle and lower elevations but are comparatively minor species above 4,000 ft (1,200 m). Other species of grama including black (*B. eriopoda*), side oats (*B. curtipendula*), slender (*B. filiformis*), sprucetop (*B. chondrosioides*), and hairy (*B. hirsuta*) comprise about two-thirds of the perennial grass stands at the upper elevations. However, these latter species are comparatively scarce at the middle and lower elevations. Arizona cottontop (*Trichachne californica*) is a common grass throughout all of the elevations on the Experimental Range. Other species include, but are not limited to, tanglehead (*Heteropogon contortus*), bullgrass (*Muhlenbergia emersleyi*) and bush muhly (*M. porteri*), slim tridens (*Tridens muticus*) and fluffgrass (*T. pulchellus*), and curlymesquite (*Hilaria belangeri*).

Lehmann lovegrass (*Eragrostis lehmanniana*), an aggressive species that was introduced into the Southwestern United States from South Africa in 1913, is the dominant grass on about 40 percent of the Santa Rita Experimental Range. This plant is especially well adapted to the climatic patterns and edaphic conditions of southeastern Arizona (Cable 1971; Cox and Roundy 1986; Elmi 1981; Giner-Mendoza 1986; Martin 1986a; Nascimento 1988). It thrives at elevations where annual rainfall amounts vary from 10 to 15 inches (250 to 380 mm) and on sites with a dominance of sandy to sandy-loam soils (Ruyle and Cox 1985). Factors that have contributed to the spread of Lehmann lovegrass include fire, excessive livestock grazing, and drought conditions.

Among the forbs commonly found on the Santa Rita Experimental Range are alfileria (*Erodium cicutarium*), pink penstemon (*Penstemon parryi*), lupine (*Lupinus* spp.), bladderpod (*Lesquerella gordonii*), and goldpoppy (*Eschscholtzia* spp.). Succulents on the Experimental Range include cholla (*Opuntia fulgida*, *O. spinosior*, and *O. versicolor*) and prickly pear cactus (*O. engelmannii*).

Annual plants become most abundant on sites with light to moderate densities of perennial grasses and where native grasses are able to persist within a cover of Lehmann

lovegrass (Medina 1988). Spring annuals dominated largely by a variety of legumes, crucifers, and borages are found in years when the cool-season rainfall is high. The most common summer annual grasses are needle grama (*B. aristoides*) and six-week threeawn (*A. adscensionis*).

Woody Vegetation

Woody vegetation on the Santa Rita Experimental Range and other semidesert grass-shrub rangelands is dominated by stands of mesquite (*Prosopis velutina*). (While the taxonomy of *Prosopis* undergoes almost constant revision [Burkart 1976; Ffolliott and Thames 1983; Martin 1986b; Hocking 1993], it is not a purpose of this paper to clarify or update the classification on *Prosopis* species.) Mesquite occupies two general types of habitat in the Southwestern region (Conner and others 1990; Martin 1980, 1986b). Tree forms of mesquite tend to grow along riparian (streamside) corridors, while shrub forms typically occupy dry upland sites. Other frequently encountered woody species include acacia (*Acacia greggii* and *A. angustissima*), mimosa (*Mimosa biuncifera* and *M. dysocarpa*), false mesquite (*Calliandra eriophylla*), burroweed (*Haplopappus tenuisectus*), creosote bush (*Larrea tridentata*), and ocotillo (*Fouquieria splendens*). Scattered paloverde (*Cercidium microphyllum*) trees are found along drainages.

More complete listings of the herbaceous and woody plant species on the Santa Rita Experimental Range and other semidesert grass-shrub rangelands of the Southwestern region are found in Little (1962), Martin (1966, 1975), Kearney and Peebles (1969), Eyre (1980), Severson and Medina (1981), and Medina (1996).

Vegetation Site Complexes

Major vegetation site complexes on the Santa Rita Experimental Range are listed in table 1. The *Prosopis-Opuntia-Haplopappus* complex is the most extensive. It is known that changes in vegetative structure have occurred since the Experimental Range was established (Cable 1976; Humphrey and Mehrhoff 1958; Martin 1970, 1975, 1986a; Martin and Turner 1977; Medina 1996). For example, mesquite has invaded nearly 30,000 acres (12,150 ha) of previously shrub-free grassland on the Experimental Range in the past 100 years. However, while the information presented in table 1 represents a "snapshot" of the conditions 30 years ago, it is assumed to reflect the present situation largely because of the curtailment in large-scale mesquite removals.

Management of Herbaceous Vegetation

Depending on the inherent site conditions and prevailing rainfall patterns, annual herbage production (standing biomass) on semidesert grass-shrub rangelands, such as found on the Santa Rita Experimental Range can vary from less than 1,000 to over 1,500 pounds per acre (1,125 to over 1,675 kg per ha). However, the herbage production on a site can be reduced to significantly lesser amounts by overstories of woody plants that compete with the herbage for the often

Table 1—Major vegetation-site complexes on the Santa Rita Experimental Range^a.

Dominant shrubs	Annual rainfall	Elevation	Major grass genera	Major soil groups	Slope
	<i>inches</i>	<i>feet</i>			<i>percent</i>
None (<i>Prosopis</i> has been killed)	15 to 17	4,100 to 4,500	<i>Bouteloua</i> , <i>Aristida</i> , <i>Trichachne</i>	Whitehouse Caralampi Comoro	5 to 15 10 to 40 0 to 10
<i>Prosopis</i> , <i>Haplopappus</i> , <i>Opuntia</i>	10 to 13	2,900 to 3,500	<i>Aristida</i> , <i>Bouteloua</i> , <i>Trichachne</i>	Anthony Sonoita	0 to 5 1 to 8
	14 to 17	3,500 to 4,200	<i>Bouteloua</i> , <i>Aristida</i> , <i>Trichachne</i> , <i>Heteropogon</i>	Comoro Sonoita Whitehouse	0 to 3 1 to 8 10 to 35
<i>Fouquieria</i> , <i>Calliandra</i>	12 to 15	3,400 to 3,800	<i>Bouteloua</i> , <i>Aristida</i> , <i>Heteropogon</i>	Whitehouse	5 to 10
<i>Larrea</i>	12	3,100 to 3,300	<i>Muhlenbergia</i> , <i>Tridens</i>	Anthony	0 to 5
<i>Acacia</i> , <i>Opuntia</i> , <i>Fouquieria</i>	12 to 14	3,100 to 3,800	<i>Bouteloua</i> , <i>Hilaria</i> , <i>Aristida</i> , <i>Tridens</i>	Bernadina Hathaway	2 to 30 2 to 30

^aSource: Martin and Reynolds (1973).

limiting soil water and essential nutrients. Competitive relationships between herbaceous and woody vegetation are generally characteristics of forest, woodland, and shrubland ecosystems (Bartlett and Betters 1983; Ffolliott and Clary 1982). That is, as one form of vegetation (woody plants) increases in its occurrence, the other form of vegetation (herbage) decreases. Such competitive relationships occur on the Santa Rita Experimental Range and other semidesert grass-shrub rangelands (Cable 1969; Cable and Martin 1964; Kincaid and others 1959; Martin 1963, 1970; Martin and Cable 1962; Parker and Martin 1952; Patten 1978; Reynolds and Tschirley 1963, 1975; Tiedemann and Klemmedson 1971, 1977). Knowledge of these relationships is necessary in estimating the amount of forage that might be available for livestock production on rangelands with woody vegetation.

Proper management of herbaceous (forage) vegetation is a crucial factor for sustaining livestock production on semidesert grass-shrub rangelands, which is often a primary management goal in the Southwestern region. Among the issues that a manager must confront in meeting this goal are selecting the type of livestock that are suitable to the conditions encountered, designating the proper stocking rates for the rangeland, and implementing the livestock grazing systems that will sustain the forage resources at the desired level of production while maintaining a "healthy" rangeland condition. Forage management practices that are often implemented to sustain or, where feasible, increase this limiting resource include the control of competing woody vegetation, elimination of undesirable herbaceous plants, and seeding of selected forage species. Other management activities that can lead to sustaining or enhancing forage resources (but will not be addressed in this paper) are fencing to control livestock movements, constructing stock tanks and developing other water sources, and placing salt

or salt-meal blocks at strategic locations to attain better distributions of livestock on the rangeland (Heitschmidt and Stuth 1991; Holechek and others 2001; Jemison and Raish 2000; Stoddart and others 1975; Vallentine 2001).

Sustaining Forage Resources Through Livestock Grazing

Cattle are better suited to graze on semidesert grass-shrub rangelands than sheep or goats because they require less managerial effort (herding) than other kinds of livestock, and they compete less directly with indigenous wildlife for forage resources (Bohning and Martin 1956; Culley 1947; Gamougoun 1987; Herbel 1979; Martin 1966, 1975). Therefore, cattle have been and continue to be the primary type of livestock that graze on the Santa Rita Experimental Range.

A "rule of thumb" for specifying the stocking rate of cattle for a semidesert grass-shrub rangeland to maintain or, where possible, improve the rangeland condition is the number of cattle that will utilize about 40 percent of the perennial grasses produced in an "average" year. This stocking rate varies with the rangeland condition and must be adjusted up or down depending on the trend in rangeland condition. The estimated average yearlong stocking rates for cattle on the Santa Rita Experimental Range are shown in table 2. According to Martin (1975), the stocking rates that are presented in this table also apply to the entire spectrum of semidesert grass-shrub rangelands in the Southwestern region and the rangeland conditions encountered.

Yearlong grazing has historically been the most common grazing system on semidesert grass-shrub rangelands. Unfortunately, this grazing system can result in "excessive" forage consumption in areas where cattle concentrate, and

Table 2—Estimated average yearlong stocking rates of cattle by rangeland condition class for the Santa Rita Experimental Range and other semidesert grass-shrub rangelands in the Southwestern Region^a.

Elevation	Precipitation	Rangeland condition class					
		Very poor		Poor to fair		Good to excellent	
<i>feet</i>	<i>inches</i>	<i>animals per m²</i>	<i>acres per animal</i>	<i>animals per m²</i>	<i>acres per animal</i>	<i>animals per m²</i>	<i>acres per animal</i>
4,000 to 5,000	16+	<12	>50	15 to 18	35 to 45	28 to 25	25 to 35
3,300 to 4,000	12 to 16	<6	>100	6 to 12	50 to 100	12 to 16	40 to 50
<3,300	<12	<4	>160	4 to 6	100 to 160	6 to 10	60 to 100

^aSource: Reynolds and Martin (1968).

“wasted” forage resources on sites where cattle seldom graze (Cable and Martin 1975; Herbel 1979; Martin 1972, 1975; Martin and Ward 1976; Reynolds 1959). Yearlong grazing can also lead to the inequitable use of forage species among the available forage species, with “favorite species” grazed more closely and more often than those species that are less palatable. Because of these and other drawbacks, the sustainability of the forage resources is difficult to attain on many semidesert, grass-shrub rangelands when yearlong grazing is practiced. As a consequence, several alternatives to yearlong grazing have been proposed, tested, and implemented in attempting to better sustain the forage resources on these rangelands. These alternatives include seasonal (spring) grazing systems, rest-rotational systems, high-intensity short-duration grazing systems, and variations and combinations of these systems.

The so-called “Santa Rita three-pasture” system of cattle grazing has evolved on the Experimental Range. Each unit of the three-pasture system is rested from March through October (spring-summer) in 2 out of 3 years (Martin 1973, 1975, 1978; Martin and Severson 1988; Rivers and Martin 1980). Winter grazing (November to February) takes place between two successive March-to-October rest periods. Trampling by cattle in the winter helps to plant seeds in the soil, and grazing of the older forage allows seedlings of intolerant forage species a better chance of becoming established. The system’s grazing schedule provides 12 months of rest immediately before each period of spring-summer grazing and, as a consequence, the system is planned to reduce the intensity of grazing and regrowth of “favorite forage plants” in the spring. The Santa Rita three-pasture system is more flexible in its implementation and management than other grazing systems tested on the Experimental Range because departures from the pre-established livestock grazing schedule are permitted if it becomes necessary to sustain the forage resource. Cattle are normally moved twice (November 1 and March 1), although they can be moved to the next pasture ahead of the scheduled time if the forage resource on the grazed pasture is inadequate. Therefore, a forage shortage tends to speed up the grazing cycle, although the “normal schedule” is resumed as soon as possible thereafter. A forage surplus can allow an extra rest period to be scheduled.

A comprehensive paper on grazing systems and livestock production on the Santa Rita Experimental Range and other semidesert grass-shrub rangelands in the Southwestern United States is found elsewhere in these proceedings.

Control of Competing Woody Vegetation

Several factors have been identified by researchers as being responsible for the invasion of mesquite and other unwanted woody vegetation onto the Santa Rita Experimental Range and other semidesert grass-shrub rangelands in the past 100 years (Fisher and others 1973; Herbel 1979; Martin 1975; McPherson 1997). The consensus of these researchers is that grazing cattle have likely been the most dominant of these factors. Grazing cattle can spread the seeds of these woody plants by consuming them with many seeds, and then passing them through their digestive tract and depositing them on the ground as they graze. Cattle have further contributed to this invasion by “weakening” stands of native grasses by their past overgrazing patterns, which in turn fostered the spread of woody vegetation. Excessive overgrazing practices of the past also contributed to the invasion of woody plants by reducing the buildup of fuels necessary for the occurrence of rangeland fires that helped to control this invasion.

Semidesert grass-shrub rangelands infested with mesquite and other woody plants can often be restored to a comparatively high level of forage productivity if the competing woody overstory is removed. Among the methods that have been tested and, on occasional, operationally implemented for this purpose are controlled burning treatments (Cable 1967; Reynolds and Bohning 1956); applications of herbicides (Cable 1971, 1972b, 1976; Cable and Martin 1975; Cable and Tschirley 1961; Martin 1968; Martin and Cable 1974); hand grubbing, root plowing, cabling or chaining, or other mechanical treatments (Martin 1975; Reynolds and Tschirley 1963); and varying applications of fire, herbicides, and mechanical control methods in combination (Martin 1975; Martin and others 1974; Medina 1996). The environmental concerns of the public and regulations of rangeland management agencies are restricting or, in some case, prohibiting the use of some of these control methods, especially those involving applications of herbicides.

Followup treatments have often been necessary with some of these control methods to sustain the observed increase in production of forage vegetation. For example, the removal of mesquite trees with a power saw with control of post-treatment sprouting by handsawing has recently been attempted with some success (Pease and others 2000).

Elimination of Undesirable Herbaceous Plants

There have been a few “exploratory investigations” of methods that can lead to the elimination of undesirable (noxious) herbaceous plants to favor the establishment and increase the production of “more favored” forage plants. Artificial shade has been shown to favor the development of Arizona cottontop, bush muhly, plains bristlegrass (*Setaria macrostachya*), and other forage species that are adapted to shade (Tiedemann and others 1971). Limited tests have indicated that pre-emergence winter applications of herbicides (dicamba, glyphosate, and picloram) to eliminate undesirable annual plants are largely ineffective. On the other hand, summer herbicidal treatments (atrazine, dicamba, and tebuthiuron) can be effective in eliminating some species of competing annuals (Al-Mashhdany 1978). The removal of competing herbaceous plants by clipping their previous summer’s biomass has resulted in increased production of sideoats grama (de Andrade 1979). However, most of the methods that might eliminate undesirable or competing herbaceous plants have not been applied on a large-scale basis because of economic and environmental considerations.

Seeding of Forage Species

Forage production has been improved on the Santa Rita Experimental Range by the seeding of selected forage species, with the seeding of perennial grasses preferred to seeding of other plants in most instances. The results of early, often small-scale investigations of seeding experiments were summarized by Glendening (1937a,b,c, 1939a,b, 1942) and other researchers. Later studies considered the respective roles of site quality, rainfall amount and timing, and other factors that might affect seeding success in more detail (Anderson and others 1957; Medina 1996). Level sites with deep, fertile, medium-textured soils that are able to maintain moisture levels conducive to plant survival have been determined to be the best candidates for seeding. Other research efforts examined the relative successes of alternative seeding methods (Cox and Martin-R 1984; Cox and others 1986), varying site preparation techniques (Slayback and Cable 1970), and applications of fertilizers to alleviate nutrient deficiencies (Holt and Wilson 1961; Martin 1975). It has been generally concluded that successful seeding of forage species requires continual control of the competing vegetation and that cattle grazing be closely controlled or excluded from the seeded rangeland.

A more detailed paper on seeding techniques and their comparative successes and other revegetation practices that have been tested on the Santa Rita Experimental Range to improve forage production is presented elsewhere in these proceedings.

Impacts of Fire

The historical impact of fire on the vegetation of semi-desert grass-shrub rangelands is unclear. Early photographs of the Santa Rita Experimental Range show extensive grassland communities free of trees and shrubs that are currently dominated by woody overstories with perennial grasses and

other herbaceous plants in the understories. According to researchers, this change has likely come about because of a lack of naturally occurring wildfire to burn freely in the more recent years. Wright (1980, 1990) and others believe that occasional fires in combination with cycles of drought played a significant role in controlling the establishment of small trees and shrubs and, therefore, kept the rangelands as predominately grassland ecosystems. This situation changed with enforcement of the fire suppression policies established by the Southwestern Region’s management agencies in the 1900s. The wildfire frequencies of 5 to 10 years that were commonly encountered before 1900 have lengthened to 25 years and longer (Kaib and others 1999; Swetnam and Baisan 1996), with this change attributed largely to the implementation of these fire suppression policies and changes in land-use practices in the region.

Much of the controlled burning that has occurred on the Santa Rita Experimental Range since its establishment had been prescribed to kill or control the woody vegetation that was competing with forage vegetation for the limited soil moisture available for plant growth. Both early-season and late-season burning treatments have been tested for this purpose with varying results. Small trees and shrubs appear to be susceptible to early-season burning. Herbaceous species such as Lehmann lovegrass and Santa Rita threeawn seem to survive early-season burning very well; Arizona cottontop, Rothrock grama, and tanglehead survives intermediately well; and black grama and tall threeawns are easily damaged by fire (Cable 1965, 1967, 1972a; Glendening and Paulsen 1955; Martin, 1975; Reynolds and Bohning 1956; White 1969). Late-season burning has also resulted in the killing of smaller mesquite trees, many other woody plant species, and cacti. Lehmann lovegrass often eventually increases following a late-season fire with most of the other perennial grass species not greatly affected (Humphrey and Everson 1951; Martin 1983; Humphrey 1963, 1969).

The “immediate effects” of prescribed burning treatments on herbaceous (forage) vegetation of semidesert grass-shrub rangelands can be relatively short lived. The postfire status of perennial grasses often lasts 1 or 2 years, while small trees and shrubs might be easily topkilled by burning but come back quickly unless they are also rootkilled by the fire (Cable 1967; Cave and Patten 1984; Martin 1975; McLaughlin and Bowers 1982; Robinett 1994; Robinett and Barker 1996; Rogers and Vint 1987; Ruyle and others 1988; Sumrall and others 1990). Most burning treatments favor plant species that can survive the fire or quickly reproduce themselves from seed or sprouts after the fire. Selective prescribed burning treatments at specified intensities and suitable intervals that are scheduled in combination with other rangeland improvement methods are generally necessary to achieve the desired results (Wright 1980, 1990).

The effects of fire on the vegetation of semidesert grass-shrub rangelands are species specific, season specific, and site specific. Many fire-adapted species, both herbaceous and woody, have achieved dominance on these rangelands because of mechanisms that enable them to survive burning (table 3). However, the traits that might enhance a plant’s success for survival in the presence of fire can also enhance the plant’s success in the presence of other stressful environmental factors (McPherson 1995). Therefore, caution must be exercised in interpreting the stimulus for these adaptive

Table 3—Mechanism of plants at different life stages that enable them to survive fire^a.

Life stage	General response	Mechanisms
Seeds	Avoidance	Burial
	Resistance	Insulative seed coat; protective tissue around fruit
	Stimulus	Increased germination; mortality of established neighbors
Juveniles	Avoidance	Rapid growth to resistance (protected) size
	Resistance	Aboveground buds protected by insulative plant tissue; belowground buds protected by soil
	Stimulus	Rapid growth of resprouts
Adults	Avoidance	Life cycle shorter than fire-return interval; flowering and fruiting phenology out of phase with fire season; suppression of understory fine fuel production
	Resistance	Thick, platy, corky, fissured bark; aboveground buds protected by insulative plant tissue; belowground buds protected by soil
	Stimulus	Rapid growth of resprouts; fire-obligate flowering; increase flowering (?)

^aSource: Steuter and McPherson (1995).

traits. Plant species are usually most susceptible to fire damage when they are actively growing and tolerant of fire when they are dormant.

Management of Woody Vegetation

This discussion centers largely on the management (or lack thereof) of mesquite trees and shrubs because of the dominance of this species in the woody overstory on the Santa Rita Experiment Range. Mesquite is a plant of often conflicting values. Mesquite is often associated with nitrogen-fixing *Rhizobia* bacteria, which results in higher nitrogen levels in the soil beneath the tree canopies (Geesing and others 2000; Wilson and others 2001). It has been and continues to be a source of wood, chemicals and, on occasion, feed for ruminants. It also provides shade for people and their livestock on sites where there is little other shade available. But, as already mentioned in this paper, many ranchers view mesquite as a threat to livestock production because of its aggressive spreading onto otherwise productive semidesert grass-shrub rangelands (Glendening 1952; Herbel 1979; Martin 1975, 1986a; McPherson 1997; Parker and Martin 1952; Tschirley 1959). In spite of the efforts made to control this spread, the invasion of mesquite remains a problem of significant proportions on some rangelands. Compounding this problem is the need to also accommodate other benefits of semidesert grass-shrub rangelands in the Southwestern Region, including watershed protection, wildlife habitats, and recreation, in planning for mesquite control or harvesting activities.

Stand, Stocking, and Growth Characteristics

Mesquite trees up to diameters of 12 to 30 inches (30 to 76 cm) and heights of 20 to 50 ft (6 to 15 m) can form nearly pure even- or uneven-aged stands in habitats of favorable soil moisture conditions. Although mesquite is designated a “forest type” by the Society of American Foresters (Martin 1980), per-acre values of stand, stocking, and growth characteristics that are commonly used to characterize a forest or

woodland type have little meaning because of the high variability in these characteristics in stands of mesquite trees. Investigators in one study on the Santa Rita Experimental Range reported an average of about 85 mesquite trees per acre (about 200 mesquite per ha), but only about 60 percent of the sample plots in the study were stocked with mesquite trees (DeBano and others 1996).

Most of the volume of mesquite trees is contained in the large and mostly scattered single-stem trees along drainages, with less volume in the smaller mesquite trees and shrubs occupying the upland sites. Growth of mesquite trees is slow, with annual growth rates averaging less than 0.5 percent of the standing volume in most stands (Chojnacky 1991; Ffolliott 1999). Assuming that the dominant woody plants are mesquite trees, and using this species as a “proxy” for all of the trees growing on a site, the annual growth rate of the assemblage of trees found on semidesert grass-shrub rangelands can vary from less than 0.5 to 1.5 ft³ per acre (0.35 to 1 m³ per ha). Natural mortality of these trees prior to their decadence is also comparatively low.

Wood Production

The wood of mesquite trees has been historically used for a variety of purposes by people of the Southwest. Many of these uses originated with the American Indian, passed onto the Mexican, and then the American pioneers from the Eastern United States. Exploring the potentials of mesquite trees as a wood source for future uses continue. Mesquite wood inherently has a high calorific value (Ffolliott 1999; Hocking 1993; National Academy of Science 1980), making it a valuable firewood resource. It also makes excellent charcoal. Wood of mesquite is physically strong and durable and, as a consequence, has been and continues to be utilized locally for poles, posts, and corral rails (Ffolliott 1999). Mesquite wood is hard and has a beauty of grain and color that also makes it suitable for processing into furniture, parquet flooring, and miscellaneous novelties.

Efficiently harvesting mesquite trees is one of the main problems that has limited its more widespread use for timber, firewood, and chemical products. The type of harvesting equipment that is available for felling, grappling, and hauling larger trees of more “commercial value” is not

always economically or environmentally suitable for harvesting the relatively small and characteristically multi- and crooked-stemmed mesquite trees. Nevertheless, there are a few small wood processing industries in the Southwestern United States that are dependent on harvesting mesquite trees as a primary wood source in their operations.

Management Practices

Management of mesquite trees for sustainable wood production has not been a main focus of the past or present management activities on the Santa Rita Experimental Range or other semidesert grass-shrub rangelands in the Southwestern Region. However, mesquite trees continue to gain attention for crafting woodworking and a product for grilling gourmet food, and, therefore, could represent a valuable resource in the future. As a consequence, there is a need to better “manage” rather than “mine” the mesquite resources in the region. Appropriate management guidelines for this purpose have been generally lacking in the past, although this situation is changing.

More accurate estimates of the volume of mesquite trees that are potentially available for wood products are being obtained (Andrews 1988; Chojnacky 1988; O'Brien 2002) to provide a better basis to prescribe management practices and, where appropriate, harvesting schedules to balance volume removals and growing-stock levels. Whole-stand growth and volume simulation (prediction) models depicting the difference of stand volumes at two selected points in time to estimate growth are also available (Chojnacky 1991). While regeneration and other ingrowth components of mesquite stands are still largely missing in these models, simulations of mesquite growth rates for alternative management practices can be made for selected 10-year planning periods. Culmination of mean (average) annual growth increments of mesquite trees on the Santa Rita Experimental Range suggests a “biological” rotation age of about 45 to 50 years. However, the profits (returns less costs) obtained from harvesting mesquite trees for primary wood products are likely to be maximized earlier.

Silvicultural Prescriptions

Silvicultural prescriptions for mesquite stands are incomplete. But, because of its ability to regrow (sprout) following cutting, silvicultural treatments based on coppicing (which is the regeneration of stump sprouts or root suckers) might be feasible on sites supporting mesquite stands such as those on the Santa Rita Experimental Range. Therefore, the reproduction of mesquite trees based on vegetative strategies could be possible (Ffolliott 1999; Ffolliott and others 1995). Artificial propagation depending on seeding or seedling establishment is more difficult and probably not economically or environmentally feasible for mesquite on most semidesert grass-shrub rangelands.

Felker (1998) recommended that mesquite trees on Southwestern rangelands be managed for the production of high quality wood within a silvopastoral (trees and livestock) agroforestry system that retains a number of selected crop trees within a pasture. A spacing of 30 to 35 ft (10 to 10.5 m) between the crop trees should result in optimal yields (Felker and others 1990).

Impacts of Fire

Fire has played a historical role in determining the status of mesquite trees and shrubs on the Santa Rita Experimental Range and other semidesert grass-shrub rangelands (Blydenstein 1957; Cable 1965; McLaughlin and Bowers 1982; McPherson 1997; Reynolds and Bohning 1956; Rogers and Steele 1980; Womack 2000; Wright and others 1976). The mostly lightning-ignited and often uncontrolled fire of the past helped to slow the invasion of mesquite onto semidesert, grass-shrub rangelands. However, the slowing of mesquite invasion by occurrences of wildfire largely ended with the initiation of aggressive fire suppression policies by management agencies in the early 1900s. Many of these policies remain in effect, although there is increasing interest by managers, ranchers, and other stakeholders in reintroducing fire into Southwestern ecosystems.

Mesquite can also be adapted to fire depending on the fire's intensity. For example, it was found that an illegally set fire (of unknown burning intensity) on the Santa Rita Experimental Range only killed 30 percent of the mature mesquite trees and reduced residual stocking by only 10 percent because over 70 percent of the trees initially damaged by the fire resprouted by 18 months after the fire (DeBano and others 1996).

Prescribed burning treatments that are planned to be low in intensity and limited in extent are rarely successful in effectively controlling the establishment of dense stands of mesquite on semidesert grass-shrub rangelands because of the frequent lack of sufficient fuel loads to carry the fire (Ffolliott 1999; Martin 1973, 1975). Furthermore, a fire that is “hot” enough to kill mesquite is likely to also kill the understory grasses and other forage species.

Other Woody Species

The use of other tree species on the Santa Rita Experimental Range and other semidesert grass-shrub rangelands for wood production has not often been a planned management activity. One occasional exception to this situation has been when the trees have been mechanically uprooted or killed by herbicides in conversion treatments to improve forage production and are then “salvaged” for firewood by local people (Ffolliott and others 1979, 1980).

Vegetation Management for Other Purposes

The vegetation on the Santa Rita Experimental Range and other semidesert grass-shrub rangelands in the Southwestern region has values other than livestock forage or wood production (Ffolliott 1999; Germano and others 1983; Martin 1986b; McPherson 1997). This vegetation furnishes needed food and protective cover for a variety of mammals, avifauna, and herpetofauna. Many of these wildlife species are indigenous to semidesert grass-shrub rangelands, others are transitory, and some are threatened, endangered, or sensitive.

Ethnobotanists are continually locating indigenous plant species that had been used by historic peoples, which are then studied, developed, and when they have proven value,

incorporated into “modern” food and fiber products of value to people. Organic agriculture enterprises often develop with these native plants furnishing a basis.

Overland flows of surface runoff, when they occur, are lower in velocity and, therefore, are less erosive when these rangelands have a “good protective cover” of perennial grasses and other herbaceous plants than on rangelands with a sparse vegetative cover. As a result, maintaining a protective cover of vegetation helps to mitigate the losses of soil to the erosive actions of water and wind on sites susceptible to these losses. Therefore, good rangeland management is also good watershed management.

Semi-desert grass-shrub rangelands are important to hunters, hikers, and birdwatchers. They possess unique landscapes of vegetation and topography that appeal to local residents and visitors alike.

Summary

Southwestern semidesert grass-shrub rangeland vegetation has historically supported a livestock industry and been a source of limited wood for a variety of mostly local uses. However, the review of past and present vegetation management practices tested on the Santa Rita Experimental Range and implemented on other semidesert grass-shrub rangelands presented in this paper suggests that the diversity of vegetation on these rangelands has values other than only forage or wood production. This vegetation furnishes food and protective cover for a variety of desert-dwelling wildlife species; provides a protective cover to mitigate the losses of soil resources; and is a valuable backdrop to hikers, campers, and other recreationists. Future management emphasis for this vegetation, therefore, is likely to be placed more on evaluating the effectiveness of ecosystem-based, multiple-use management practices that are ecologically sustainable and environmentally sound. A presentation on the future of the Santa Rita Experimental Range and other semidesert grass-shrub rangelands in the Southwestern United States is found elsewhere in these proceedings.

References

- Anderson, D.; Hamilton, L. P.; Reynolds, H. G.; Humphrey, R. R. 1957. Reseeding desert ranges in southern Arizona. Bull. 249. Tucson: University of Arizona, Agricultural Experiment Station. 31 p.
- Andrews, S. A. 1988. Volume estimation and multi-purpose management of *Prosopis velutina* in southern Arizona. Tucson: University of Arizona. 67 p. Thesis.
- Al-Mashhdany, S. A. 1978. Chemical control of the annual weeds of southern Arizona rangeland. Tucson: University of Arizona. 55 p. Thesis.
- Bartlett, E. T.; Betters, D. R., eds. 1983. Overstory-understory relationships in Western forests. West. Reg. Res. Publ. 1. Fort Collins: Colorado State University, Colorado State University Experiment Station. 37 p.
- Blydenstein, J. 1957. The survival of velvet mesquite (*Prosopis juliflora* var. *velutina*) after fire. Journal of Range Management. 10: 221–223.
- Bohning, J. W.; Martin, S. C. 1956. One rancher's experience—in the grassland range of southern Arizona. Journal of Range Management. 9: 258–260.
- Burkart, A. 1976. A monograph of the genus *Prosopis* (Mimosoideae). Journal of the Arnold Arboretum. 57: 219–249, 450–525.
- Cable, D. R. 1965. Damage to mesquite, Lehmann lovegrass and black grama by a hot June fire. Journal of Range Management. 18: 326–329.
- Cable, D. R. 1967. Fire effects on semidesert grasses and shrubs. Journal of Range Management. 20: 170–176.
- Cable, D. R. 1969. Competition in the semidesert grass-shrub type as influenced by root systems, growth habits, and soil moisture extraction. Ecology. 50: 28–38.
- Cable, D. R. 1971. Lehmann lovegrass on the Santa Rita Experimental Range. Journal of Range Management. 24: 17–21.
- Cable, D. R. 1972a. Fire effects in Southwestern semidesert grass-shrub communities. Tall Timbers Fire Ecology Conference. 12: 109–127.
- Cable, D. R. 1972b. Fourwing saltbush revegetation trials in southern Arizona. Journal of Range Management. 25: 150–153.
- Cable, D. R. 1975. Influence of precipitation on perennial grass production in the semidesert Southwest. Ecology. 56: 981–986.
- Cable, D. R. 1976. Twenty years of changes in grass-reduction following mesquite control and reseeding. Journal of Range Management. 29: 286–289.
- Cable, D. R.; Martin, S. C. 1964. Forage production and stocking rates on southern Arizona ranges can be improved. Res. Note RM-30. Fort Collins, CO: U.S. Department of Agriculture, Forest Service, Rocky Mountain Forest and Range Experiment Station. 11 p.
- Cable, D. R.; Martin, S. C. 1975. Vegetation responses to grazing, rainfall, site condition, and mesquite control on semidesert range. Res. Pap. RM-149. Fort Collins, CO: U.S. Department of Agriculture, Forest Service, Rocky Mountain Forest and Range Experiment Station. 24 p.
- Cable, D. R.; Tschirley, F. H. 1961. Responses of native and introduced grasses following aerial spraying of velvet mesquite in southern Arizona. Journal of Range Management. 14: 155–159.
- Cave, G. H.; Patten, D. T. 1984. Short-term vegetation responses to fire in the upper Sonoran Desert. Journal of Range Management. 37: 491–496.
- Chojnacky, D. C. 1988. Juniper, pinyon, oak, and mesquite volume equations for Arizona. Res. Pap. INT-391. Ogden, UT: U.S. Department of Agriculture, Forest Service, Intermountain Research Station. 11 p.
- Chojnacky, D. C. 1991. Growth prediction for Arizona's mesquite (*Prosopis velutina*) woodlands. Forest Ecology and Management. 42: 292–310.
- Conner, R. C.; Born, J. D.; Green, A. W.; O'Brien, R. A. 1990. Forest resources of Arizona. Resour. Bull. INT-69. Ogden, UT: U.S. Department of Agriculture, Forest Service, Intermountain Research Station. 92 p.
- Cox, J. R.; Martin-R., M. H. 1984. Effects of planting depth and soil texture on the emergence of four lovegrasses. Journal of Range Management. 37: 204–205.
- Cox, J. R.; Martin-R., M. H.; Ibarra-F., F. A.; Morton, H. L. 1986. Establishment of range grasses on various seedbeds at creosotebush (*Larrea tridentata*) sites in Arizona, U.S.A., and Chihuahua, Mexico. Journal of Range Management. 39: 540–546.
- Cox, J. R.; Roundy, G. B. 1986. Influence of climatic and edaphic factors on the distribution of *Eragrostis lehmanniana* in Arizona, U.S.A. Journal of the Grassland Society of South Africa. 3: 25–29.
- Culley, M. 1948. Modern business methods in handling cattle. Arizona Stockman. 14(4): 13, 26–27.
- de Andrade, I. F. 1979. Growth response of sideoats grama to seasonal herbage removal and competition from adjacent vegetation. Tucson: University of Arizona. 90 p. Dissertation.
- DeBano, L. F.; Gottfried, G. J.; Villanueva-Diaz, J.; Ffolliott, P. F.; Valdez-Zamudio, D. 1996. Initial assessment of fire-damaged mesquite trees following an illegal burn. In: Ffolliott, P. F.; DeBano, L. F.; Baker, M. B., Jr.; Gottfried, G. J.; Solis-Garza, G.; Edminster, C. B.; Neary, D. G.; Allen, L. S.; Hamre, R. H., tech. coords. Effects of fire on Madrean Province ecosystems: a symposium proceedings. Gen. Tech. Rep. RM-GTR-289. Fort Collins, CO: U.S. Department of Agriculture, Forest Service, Rocky Mountain Forest and Range Experiment Station: 226–228.
- Elmi, A. A. 1981. Phenology, root growth and root carbohydrates of Lehmann lovegrass (*Eragrostis lehmanniana*) in response to grazing. Tucson: University of Arizona. 58 p. Thesis.
- Eyre, F. H., ed. 1980. Forest cover types of the United States and Canada. Washington, DC: Society of American Foresters. 148 p.

- Felker, P. 1998. The value of mesquite for the rural Southwest: fine lumber and soil improvement. *Journal of Forestry*. 96(1): 16–20.
- Felker, P.; Meyer, J. M.; Gronski, S. J. 1990. Application of self-thinning in mesquite (*Prosopis glandulosa* var. *glandulosa*) to range management and lumber production. *Forest Ecology and Management*. 31: 225–232.
- Ffolliott, P. F. 1999. Mesquite ecosystems in the Southwestern United States. In: Ffolliott, P. F.; Ortega-Rubio, A., eds. *Ecology and management of forests, woodlands, and shrublands in the dryland regions of the United States and Mexico*. La Paz, Mexico: University of Arizona, Centro de Investigaciones Biológicas del Noroeste, U.S. Department of Agriculture, Forest Service: 95–106.
- Ffolliott, P. F.; Clary, W. P. 1982. Understory-overstory vegetation relationships: an annotated bibliography. Gen. Tech. Rep. INT-136. Ogden, UT: U.S. Department of Agriculture, Forest Service, Intermountain Forest and Range Experiment Station. 39 p.
- Ffolliott, P. F.; Thames, J. L. 1983. Handbook on the taxonomy of *Prosopis* in Mexico, Peru, and Chile. Rome, Italy: Food and Agriculture Organization (FAO) of the United Nations. 45 p.
- Ffolliott, P. F.; Rasmussen, W. O.; Patterson, J. G. 1980. Biomass energy: potentials in Arizona. *Biosources Digest*. 2: 240–247.
- Ffolliott, P. F.; Brooks, K. N.; Gregersen, H. M.; Lundgren, A. L. 1995. *Dryland forestry: planning and management*. New York: John Wiley & Sons, Inc. 453 p.
- Ffolliott, P. F.; Rasmussen, W. O.; Warfield, T. K.; Borland, D. S. 1979. Supply, demand, and economics of fuelwood markets in selected population centers of Arizona. *Arizona Land Marks*. 9: 1–74.
- Fisher, C. E.; Hoffman, G. O.; Scifres, C. J. 1973. The mesquite problem. In: *Mesquite growth and development, management, economics, and use*. Res. Monog. 1. College Station: Texas A&M University, Texas Agricultural Experiment Station: 5–9.
- Gamougoun, N. D. 1987. Cattle grazing behavior and range plant dynamics in southern Arizona. Tucson: University of Arizona. 235 p. Thesis.
- Geesing, D.; Felker, P.; Bingham, R. L. 2000. Influence of mesquite (*Prosopis glandulosa*) on soil nitrogen and carbon development: implications for global carbon sequestration. *Journal of Arid Environments*. 36: 157–180.
- Germano, D. J.; Hungerford, R.; Martin, S. C. 1983. Responses of selected wildlife species to the removal of mesquite from desert grasslands. *Journal of Range Management*. 36: 309–311.
- Giner-Mendoza, M. 1986. Effect of clipping on photosynthesis, respiration and production of *Eragrostis lehmanniana* Ness and *Digitaria californica* (Benth.) Henr. Tucson: University of Arizona. 54 p. Thesis.
- Glendening, G. E. 1937a. A method of revegetating small key plots on eroded areas. Res. Note 8. Tucson, AZ: U.S. Department of Agriculture, Forest Service, Southwestern Forest and Range Experiment Station. 2 p.
- Glendening, G. E. 1937b. Litter aids germination of grass seeds and establishment of seedlings. Res. Note 7. Tucson, AZ: U.S. Department of Agriculture, Forest Service, Southwestern Forest and Range Experiment Station. 2 p.
- Glendening, G. E. 1937c. Reseeding on denuded "adobe flats." Res. Note 19. Tucson, AZ: U.S. Department of Agriculture, Forest Service, Southwestern Forest and Range Experiment Station. 2 p.
- Glendening, G. E. 1939a. Comparison of the effects of various kinds of artificial litter upon the germination of grass seeds. Res. Note 61. Tucson, AZ: U.S. Department of Agriculture, Forest Service, Southwestern Forest and Range Experiment Station. 2 p.
- Glendening, G. E. 1939b. How to establish black grama on depleted semidesert ranges. Res. Note 52. Tucson, AZ: U.S. Department of Agriculture, Forest Service, Southwestern Forest and Range Experiment Station. 4 p.
- Glendening, G. E. 1942. Germination and emergence of some native grasses in relation to litter cover and soil moisture. *Journal of the American Society of Agronomy*. 34: 794–804.
- Glendening, G. E. 1952. Some quantitative data on the increase of mesquite and cactus on a desert grassland range in southern Arizona. *Ecology*. 33: 319–328.
- Glendening, G. E.; Paulsen, H. A., Jr. 1955. Reproduction and establishment of velvet mesquite as related to invasion of semidesert grasslands. Tech. Bull. 1127. Washington, DC: U.S. Department of Agriculture. 50 p.
- Heitschmidt, R. K.; Stuth, J. W. 1991. *Grazing management: an ecological perspective*. Portland, OR: Timber Press. 259 p.
- Herbel, C. H. 1979. Utilization of grass- and shrublands of the south-western United States. In: Walker, B. H., ed. *Management of semi-arid ecosystems*. Amsterdam, The Netherlands: Elsevier Scientific Publishing Company: 161–203.
- Hocking, D. 1993. *Trees for drylands*. New York: International Science Publishers. 370 p.
- Holechek, J.; Pieper, R. D.; Herbel, C. H. 2001. *Range management: principles and practices*. Upper Saddle River, NJ: Prentice Hall. 587 p.
- Holt, G. A.; Wilson, D. G. 1961. The effect of commercial fertilizers on forage production and utilization on a desert grassland site. *Journal of Range Management*. 14: 252–256.
- Humphrey, R. R. 1953. The desert grassland, past and present. *Journal of Range Management*. 6: 159–164.
- Humphrey, R. R. 1963. The role of fire in the desert grasslands of Arizona. Tall Timbers Fire Ecology Conference. 2: 45–62.
- Humphrey, R. R. 1969. The past role of fire in range management in the Southwest and some future possibilities. In: Wagle, R. F., ed. *Fire ecology and control and use of fire in wildland management: proceedings of a symposium*. Tucson: Arizona Academy of Science, Society of American Foresters, Southwestern Inter-agency Fire Committee: 52–56.
- Humphrey, R. R.; Everson, A. C. 1951. Effect of fire on mixed grass-shrub range in southern Arizona. *Journal of Range Management*. 4: 264–266.
- Humphrey, R. R.; Mehrhoff. 1958. Vegetation changes on a southern Arizona grassland. *Ecology*. 39: 720–726.
- Jemison, R.; Raish, C., eds. 2000. *Livestock management in the American Southwest: ecology, society, and economics*. Amsterdam, The Netherlands: Elsevier. 597 p.
- Kaib, M.; Swetnam, T. W.; Baisan, C. H. 1999. Fire history in canyon pine-oak forests, intervening desert grasslands, and higher-elevation mixed conifer forests of the Southwest Borderlands. In: Gottfried, G. J.; Eskew, L. G.; Curtin, C. G.; Edminster, C. B., comps. *Toward integrated research, land management, and ecosystem protection in the Malpai Borderlands: conference summary*. Proc. RMRS-P-10. Fort Collins, CO: U.S. Department of Agriculture, Forest Service, Rocky Mountain Research Station: 57–64.
- Kearney, T. H.; Peebles, R. H. 1969. *Arizona flora*. Berkeley: University of California Press. 1,085 p.
- Kincaid, D. R.; Holt, G. A.; Dalton, P. D.; Tixier, J. S. 1959. The spread of Lehmann lovegrass as affected by mesquite and native grasses. *Ecology*. 40: 738–742.
- Little, E. L., Jr. 1962. *Southwestern trees: a guide to the native species of New Mexico and Arizona*. Agric. Handb. 9. Washington, DC: U.S. Department of Agriculture, Forest Service. 109 p.
- Martin, S. C. 1963. Grow more grass by controlling mesquite. *Progressive Agriculture in Arizona*. 15(4): 15–16.
- Martin, S. C. 1966. The Santa Rita Experimental Range. Res. Pap. RM-22. Fort Collins, CO: U.S. Department of Agriculture, Forest Service, Rocky Mountain Forest and Range Experiment Station. 24 p.
- Martin, S. C. 1968. Improving semidesert ranges in southern Arizona, USA, by grazing management and shrub control. *Annals of Arid Zone*. 7: 235–242.
- Martin, S. C. 1970. Vegetation changes on semidesert range during 10 years of summer, winter, and year-long grazing by cattle. Eleventh International Grassland Congress Proceedings: 23–26.
- Martin, S. C. 1972. Some effects of continuous grazing on forage production. *Arizona Cattalog*. 28(10): 17–18, 23–25.
- Martin, S. C. 1973. A grazing system for semidesert ranges based on responses to seasonal rest. In: *Abstracts of papers: 26th annual meeting of the Society for Range Management*. Denver, CO: Society for Range Management: 21.
- Martin, S. C. 1975. Ecology and management of Southwestern semidesert grass-shrub ranges: the status of our knowledge. Res. Pap. RM-156. Fort Collins, CO: U.S. Department of Agriculture, Forest Service, Rocky Mountain Forest and Range Experiment Station. 38 p.
- Martin, S. C. 1978. The Santa Rita grazing system. In: Nyder, D., ed. *Proceedings of the First International Rangeland Congress*. Denver, CO: Society for Range Management: 573–575.
- Martin, S. C. 1980. Mesquite. In: Eyre, F. H., ed. *Forest cover types of the United States and Canada*. Washington, DC: Society of American Foresters: 118.

- Martin, S. C. 1983. Response to semidesert grasses and shrubs to fall burning. *Journal of Range Management*. 36: 504–610.
- Martin, S. C. 1986a. Eighty years of vegetation changes on a semi-desert range in southern Arizona, U.S.A., and evaluation of causes. In: Ross, P. J.; Lynch, P. W.; Williams, O. B., eds. *Rangelands: a resource under siege*. Proceedings of the Second International Rangeland Congress, Canberra, Australia: Cambridge University Press: 53.
- Martin, S. C. 1986b. Values and uses for mesquite. In: Patton, D. R.; Gonzales V., C. E.; Medina, A. L.; Segura T., L. A.; Hamre, R. H., tech. coords. *Management and utilization of arid and semi-arid plants: symposium proceedings*. Gen. Tech. Rep. RM-135. Fort Collins, CO: U.S. Department of Agriculture, Forest Service, Rocky Mountain Forest and Range Experiment Station: 91–96.
- Martin, S. C.; Cable, D. R. 1962. Grass production high 14 years after mesquite control. *Arizona Cattlelog*. 18(12): 48–61.
- Martin, S. C.; Cable, D. R. 1974. Managing semidesert grass-shrub ranges: vegetation responses to precipitation, grazing, soil texture, and mesquite control. *Tech. Bull.* 1480. Washington, DC: U.S. Department of Agriculture. 45 p.
- Martin, S. C.; Reynolds, H. G. 1973. The Santa Rita Experimental Range: your facility for research on semidesert ecosystems. *Journal of the Arizona Academy of Science*. 8: 56–67.
- Martin, S. C.; Severson, K. E. 1988. Vegetation response to the Santa Rita grazing system. *Journal of Range Management*. 41: 291–295.
- Martin, S. C.; Turner, R. M. 1977. Vegetation changes in the Sonoran Desert region, Arizona and Sonora. *Journal of the Arizona Academy of Science*. 12: 59–69.
- Martin, S. C.; Ward, D. E. 1976. Perennial grasses respond inconsistently to alternate year seasonal rest. *Journal of Range Management*. 29: 346.
- Martin, S. C.; Thames, J. L.; Fish, E. B. 1974. Changes in cactus numbers and herbage production after chaining and mesquite control. *Progressive Agriculture in Arizona*. 26(6): 3–6.
- McLaughlin, S. P.; Bowers, J. E. 1982. Effects of wildfire on a Sonoran desert plant community. *Ecology*. 63: 246–248.
- McPherson, G. R. 1995. The role of fire in desert grasslands. In: McClaran, M. P.; Van Devender, T. R., ed. *The desert grassland*. Tucson: University of Arizona Press: 130–151.
- McPherson, G. R. 1997. *Ecology and management of North American savannas*. Tucson: University of Arizona Press. 208 p.
- Medina, A. L. 1988. Diets of scaled quail in southern Arizona. *Journal of Wildlife Management*. 52: 753–757.
- Medina, A. L. 1996. The Santa Rita Experimental Range: history and annotated bibliography (1903–1988). Gen. Tech. Rep. RM-GTR-276. Fort Collins, CO: U.S. Department of Agriculture, Forest Service, Rocky Mountain Forest and Range Experiment Station. 67 p.
- Nascimento, H. T. S. 1988. Pattern of utilization and response of Lehmann lovegrass (*Eragrostis lehmanniana* Nees) grazed by cattle. Tucson: University of Arizona. 195 p. Dissertation.
- National Academy of Science. 1980. *Firewood crops: shrub and tree species for energy production*. Washington, DC: National Academy of Science. 237 p.
- O'Brien, R. A. 2002. Arizona's forest resources, 1999. *Resour. Bull.* RMRS-RB-2. Ogden, UT: U.S. Department of Agriculture, Forest Service, Rocky Mountain Research Station. 116 p.
- Parker, K. W.; Martin, S. C. 1952. The mesquite problem on southern Arizona ranges. *Circ.* 98. Washington, DC: U.S. Department of Agriculture. 70 p.
- Patten, D. T. 1978. Productivity and production efficiency of an upper Sonoran Desert ephemeral community. *American Journal of Botany*. 65: 891–895.
- Pease, S.; Ffolliott, P. F.; DeBano, L. F.; Gottfried, G. J. 2000. Effects of mesquite control and mulching treatments on herbage production on semiarid shrub-grasslands. In: Ffolliott, P. F.; Baker, M. B., Jr.; Edminster, C. B.; Dillion, M. C.; Mora, K. L., tech. coords. *Land stewardship in the 21st century: the contributions of watershed management*. Proc. P-RMRS-13. Fort Collins, CO: U.S. Department of Agriculture, Forest Service, Rocky Mountain Research Station: 265–267.
- Reynolds, H. G. 1959. Managing grass-shrub cattle ranges in the Southwest. *Agric. Handb.* 162. Washington, DC: U.S. Department of Agriculture. 40 p.
- Reynolds, H. G.; Bohning, J. W. 1956. Effects of burning on desert grass-shrub range in southern Arizona. *Ecology*. 37: 769–777.
- Reynolds, H. G.; Martin, S. C. 1968. Managing grass-shrub cattle ranges in the Southwest. *Handb.* 163. Washington, DC: U.S. Department of Agriculture. 44 p.
- Reynolds, H. G.; Tschirley, F. H. 1963. Mesquite control in the Southwest. *Leaflet* 421. Washington, DC: U.S. Department of Agriculture. 8 p.
- Rivers, W. J.; Martin, S. C. 1980. Perennial grass improves with moderate stocking. *Rangelands*. 2: 105–106.
- Robinett, D. 1994. Fire effects on southeastern Arizona plains grasslands. *Rangelands*. 16: 143–148.
- Robinett, D.; Barker, S. 1996. Fire effects on Sonoran grasslands. In: Ffolliott, P. F.; DeBano, L. F.; Baker, M. B., Jr.; Gottfried, G. J.; Solis-Garza, G.; Edminster, C. B.; Neary, D. G.; Allen, L. S.; Hamre, R. H., tech. coords. *Effect of fire on Madrean Province ecosystems: a symposium proceedings*. Gen. Tech. Rep. RM-GTR-289. Fort Collins, CO: U.S. Department of Agriculture, Forest Service, Rocky Mountain Forest and Range Experiment Station: 64–68.
- Rogers, G. F.; Steele, J. 1980. Sonoran Desert fire ecology. In: Stokes, M. A.; Dieterich, J. H., tech. coords. *Fire ecology workshop: proceedings of a technical conference*. Gen. Tech. Rep. RM-81. Fort Collins, CO: U.S. Department of Agriculture, Forest Service, Rocky Mountain Forest and Range Experiment Station: 15–18.
- Rogers, G. F.; Vint, M. K. 1987. Winter precipitation and fire in the Sonoran Desert. *Journal of Arid Environments*. 13: 47–52.
- Ruyle, G. B.; Cox, J. 1985. Lehmann lovegrass—a naturalized citizen. *Arizona Farmer Stockman*. 51(4): 26.
- Ruyle, G. B.; Roundy, B. A.; Cox, J. R. 1988. Effects of burning on germinability of Lehmann lovegrass. *Journal of Range Management*. 41: 404–406.
- Sayre, N. 1999. The cattle boom in southern Arizona: towards a critical political ecology. *Journal of the Southwest*. 41: 239–271.
- Severson, K. E.; Medina, A. L. 1981. The Santa Rita Experimental Range. In: Patton, D. P.; de la Puente-E., J. M.; Ffolliott, P. F.; Gallina, S.; Bartlett, E. T., tech. coords. *Wildlife and range research needs in Northern Mexico and Southwestern United States*. Gen. Tech. Rep. WO-36. Washington, DC: U.S. Department of Agriculture, Forest Service: 56–59.
- Slayback, R. D.; Cable, D. R. 1970. Larger pits aid reseeding of semidesert rangeland. *Journal of Range Management*. 23: 333–335.
- Steuter, A. A.; McPherson, G. R. 1995. Fire as a physical stress. In: Bedunah, D. J.; Sosebee, eds. *Physiological ecology and developmental morphology*. Denver, CO: Society for Range Management: 550–579.
- Stoddart, L. A.; Smith, A. D.; Box, T. W. 1975. *Range management*. New York: McGraw-Hill Book Company. 532 p.
- Sumrall, L. F.; Roundy, B. A.; Cox, J. R.; Winkel, V. K. 1990. Seedbed ecology of Lehmann lovegrass in relation to fire. In: Krammes, J. S., tech. coord. *Effects of fire management of Southwestern natural resources*. Gen. Tech. Rep. RM-191. Fort Collins, CO: U.S. Department of Agriculture, Forest Service, Rocky Mountain Forest and Range Experiment Station: 186–189.
- Swetnam, T. W.; Baisan, C. H. 1996. Historical fire regime patterns in the Southwestern United States since AD 1700. In: Allen, C. D., tech. coords. *Fire effects in Southwestern forests: proceedings of the 2nd La Mesa fire symposium*. Gen. Tech. Rep. RM-GTR-286. Fort Collins, CO: U.S. Department of Agriculture, Forest Service, Rocky Mountain Forest and Range Experiment Station: 11–32.
- Tiedemann, A. R.; Klemmedson, J. O. 1971. Effect of mesquite (*Prosopis juliflora*) trees on vegetation and soils in the desert grassland. In: *Abstracts: 24th annual meeting*. Reno, NV: Society for Range Management: 15–16.
- Tiedemann, A. R.; Klemmedson, J. O. 1977. Effect of mesquite trees on vegetation and soils in the desert grassland. *Journal of Range Management*. 30: 361–367.
- Tiedemann, A. R.; Klemmedson, J. O.; Ogden, P. R. 1971. Response of four perennial Southwestern grasses to shade. *Journal of Range Management*. 24: 442–447.
- Tschirley, F. H. 1959. Effect of mesquite on range productivity. In: *Your range—its management*. Spec. Rep. 2. Tucson: Arizona Agricultural Experiment Station, University of Arizona: 17.

- Vallentine, J. F. 2001. Grazing management. San Diego, CA: Academic Press. 659 p.
- White, L. D. 1969. Effects of a wildfire on several desert grassland shrub species. *Journal of Range Management*. 22: 284–285.
- Wilson, T. B.; Webb, R. H.; Thompson, T. L. 2001. Mechanisms of range expansion and removal of mesquite in desert grasslands of the Southwestern United States. Gen. Tech. Rep. RMRS-GTR-81. Fort Collins, CO: U.S. Department of Agriculture, Forest Service, Rocky Mountain Research Station. 23 p.
- Womack, J. D. 2000. Mortality and sprouting vigor of burned and cut velvet mesquite (*Prosopis velutina* Wooten): the role of basal diameter and number of stems. Tucson: University of Arizona. 61 p. Thesis.
- Wright, H. A. 1980. The role and use of fire in the semidesert grass-shrub type. Gen. Tech. Rep. INT-85. Ogden, UT: U.S. Department of Agriculture, Forest Service, Intermountain Forest and Range Experiment Station. 23 p.
- Wright, H. A. 1990. Role of fire in the management of Southwestern ecosystems. In: Krammes, J. S., tech. coord. Effects of fire management of Southwestern natural resources. Gen. Tech. Rep. RM-191. Fort Collins, CO: U.S. Department of Agriculture, Forest Service, Rocky Mountain Forest and Range Experiment Station: 1–5.
- Wright, H. A.; Bunting, S. C.; Neuenschwander, L. F. 1976. Effect of fire on honey mesquite. *Journal of Range Management*. 29: 467–471.

Wildlife Ecology and Management, Santa Rita Experimental Range (1903 to 2002)

Abstract: The Santa Rita Experimental Range (SRER), established in 1903, is a natural laboratory used to better understand desert grasslands. We reviewed the literature to summarize studies that have been conducted on wildlife at SRER from 1903 to 2002 and to provide recommendations on expanding contemporary research at SRER. Research related to wild vertebrates has been limited to a few studies of reptiles, avifauna, and mammals. Mammalian studies were dominated by rodent research. Peer-reviewed publications dominated the references ($n = 45$), followed by technical bulletins ($n = 12$), theses ($n = 9$) and dissertations ($n = 9$), conference proceedings ($n = 3$), reports ($n = 3$), and other ($n = 3$). Although research on wildlife has been limited (about 0.8 publications per year) from 1903 to 2002, several works were landmark studies that led the way for future work (for example, water requirement studies, life history studies of small mammals, studies of coyotes, and disease studies). There has not been a concentrated effort to continue wildlife research at SRER, and since 1983, only five manuscripts have been published. We recommend that land managers and administrators initiate inventory and monitoring of all vertebrates on SRER to gather new knowledge, to quantify abundance trends, and to assist with resource research and management.

Acknowledgments: Y. Petryszyn and J. A. Bissonette reviewed this manuscript. Funding to conduct the review was provided by the School of Renewable Natural Resources and the Arizona Agricultural Experiment Station, University of Arizona, Tucson.

Introduction

The Santa Rita Experimental Range (SRER) was established in 1903 as a natural laboratory to better understand arid rangelands. It is the oldest research area maintained by the USDA Forest Service. Although it was established as a research site for range improvement in the Southwestern United States, only limited research has been directed toward wildlife. The history of SRER, location, and mission are outlined by Medina (1996). The purpose of our paper is to summarize the work that has been conducted at SRER on wild vertebrates, indicate the role those studies have on a better understanding of wildlife ecology and management, and make recommendations for the future.

We obtained information from the University of Arizona's digital archive (ag.arizona.edu/SRER), Medina's bibliography (1996), and literature searches conducted at the Science Library, University of Arizona. Most of the archival data supported the published material and was not referenced again.

Although the SRER was established in 1903, it was nearly 2 decades before the first manuscript related to wildlife was published (Vorhies and Taylor 1922). In the subsequent 5 decades there were approximately 10 publications per decade. In the eighth decade of SRER (1973 to 1982), the number of publications peaked at 25. Since 1983, only five publications have been produced and more than 5 are in press or in preparation. We are unaware of ongoing research on wildlife at SRER.

Although wildlife research has been limited (about 0.8 publications per year) at SRER over the past 100 years, much of the work published are landmark studies that created a framework for future studies, were classical works that are still used as

Paul R. Krausman is Professor and Research Scientist of Wildlife and Fisheries Science in the School of Renewable Natural Resources, University of Arizona, Tucson. He also serves as Associate Director of Arizona's Agricultural Experiment Station, and Adjunct Professor at Texas Tech University, Lubbock. He has worked with large mammals in arid environments related to habitat ecology, restoration, and mitigation throughout the Southwest, and in Asia and Africa. He is also heavily involved in wildlife education and administration and is the current editor of *Wildlife Monographs*. Paul completed a B.S. degree in zoology at Ohio State University, an M.S. degree in wildlife science at New Mexico State University, and a Ph.D. degree in wildlife science at the University of Idaho. Michael L. Morrison holds affiliated positions with the Desert Research Institute, Reno, NV, and the University of California. His interests include wildlife ecology, habitat restoration, and environmental education. He received his B.S. degree in zoology from Northern Arizona University, an M.S. degree in wildlife from Texas A & M University, and a Ph.D. degree in wildlife from Oregon State University.

In: McClaran, Mitchel P.; Ffolliott, Peter F.; Edminster, Carleton B., tech. coords. Santa Rita Experimental Range: 100 years (1903 to 2003) of accomplishments and contributions; conference proceedings; 2003 October 30–November 1; Tucson, AZ. Proc. RMRS-P-30. Ogden, UT: U.S. Department of Agriculture, Forest Service, Rocky Mountain Research Station.

reference sources, provided data that are applicable to wildlife in arid regions worldwide, or were part of larger studies to examine disease in desert mammals. Each of these appeared to be initiated by individuals who were aware of the SRER instead of any unified effort by SRER administrators to direct wildlife research. For example, the early life history studies were conducted by U.S. Biological Survey biologists; the water-balance work, most coyote and rodent studies, and disease studies were directed by scientists affiliated with universities. Because of the location of SRER to the University of Arizona, it would be valuable to begin a research program with more direction in the next 100 years to maximize our ability to learn and provide more and better information related to how wildlife influences grasslands grazed by livestock and vice versa. The wildlife research conducted over the past 100 years has been limited to a few studies of reptiles, avifauna, and mammals (dominated by rodents). Peer-reviewed publications dominated the references ($n = 45$), followed by technical bulletins ($n = 12$), theses ($n = 9$), dissertations ($n = 9$), conference proceedings ($n = 3$), reports ($n = 3$), and other (references in books, popular papers, and mimeographs) ($n = 3$). In addition, projects were conducted by mammalogy students from the University of Arizona as part of class requirements (Mammal Museum, University of Arizona, Tucson). The wildlife research is categorized as related to reptiles, avifauna, and mammals.

Reptiles

Reptiles received the least amount of attention by ecologists at SRER. A distribution of rattlesnakes was based on 40 records of diamondbacks (*Crotalus atrox* Baird and Girard), six records of tiger rattlesnakes (*C. tigris* Kennicott), seven records of Mohave rattlesnakes (*C. scutulatus* Kennicott), and nine records of blacktailed rattlesnakes (*C. molossus* Baird and Girard). Diamondbacks ranged from an elevation of 854 to 1,220 m. Mohave rattlesnakes ranged from an elevation of 854 to 1,373 m, and blacktails were found in canyons from 1,281 to 1,464 m. The distribution of tiger rattlesnakes overlapped the distribution of all the other rattlesnakes (Humphrey 1936).

As mesquite was cleared from SRER in various treatments, the Sonora spotted whiptail (*Cnemidophorus sonora* Lowe and Wright) was more abundant than in areas that contained undisturbed mesquite and mesquite with irregularly shaped clearings (Germano 1978; Germano and Hungerford 1981). The studies of Germano (1978) and Germano and Hungerford (1981) were pioneer studies in considering reptiles in landscape management plans in the Southwest.

Avifauna

Studies of birds at SRER were limited, and seven of the 13 published works were related to quail. The other six articles included short notes on the first record of the pectoral sandpiper (*Calidris melanotos* Vieillot) for Arizona (Vorhies 1932), the life history and diurnal activity of the roadrunner (*Geococcyx californianus* Lesson) (Calder 1968a,b), and diet and nesting data for 20 to 55 Sonoran Desert birds (Russell

and Gould 1974; Russell and others 1972, 1973) on a 20.3-ha study plot in SRER.

Studies of quail included water requirements, productivity, diets, and life history traits (Gorsuch 1934). Whether or not water supplied for wildlife influences populations has been debated for years (Grinnell 1927; Rosenstock and others 1999; Vorhies 1928). The controversy began over 50 years ago when biologists in Western States began to supply water for game birds (MacGregor 1953). The first studies to examine the response of Gambel's quail (*Callipepla gambelii* Gambel) to water sources provided as management activities were, in part, studied at SRER (Hungerford 1960a,b).

Water supplied by humans was not important, as quail maintained body moisture from succulent plants. Vitamin A was an important part of the life history, and during dry years quail did not store enough vitamin A in their liver for successful breeding. Rainfall, as it influenced vegetation, was the driving force for quail reproduction in southern Arizona, not water provided by humans (Hungerford 1960a,b, 1964). The importance of vitamin A was first proposed by Vorhies (1928) more than 30 years earlier based on his studies of lagomorphs on SRER. Diet and physiological studies (Hungerford 1960a,b, 1962, 1964) of quail supported Vorhies' observations.

Diets of scaled quail (*Callipepla squamata* Vigors) were studied at SRER (Medina 1988). The scaled quail also selected succulent food during dry seasons. Unfortunately, additional studies of avifauna have not been conducted at SRER.

Mammals

Scientists have concentrated mammalian studies at SRER on lagomorphs, rodents, coyotes (*Canis latrans* Say), colored peccaries (*Pecari tajacu* Linnaeus), and deer (*Odocoileus* spp). However, there are only limited data for each group, and no central theme prevails. Because SRER is primarily grassland, several studies examined influences of range management practices (for example, mesquite [*Prosopis* spp.] control) on wildlife. For example, the control of mesquite (15 to 100 trees per 0.41 ha) caused a subsequent reduction of use by mourning doves (*Zenaida macroura* Linnaeus), white-winged doves (*Zenaida asiatica* Linnaeus), Gambel's quail, scaled quail, and desert cottontails (*Sylvilagus audubonii* Baird). The abundance of antelope jackrabbits (*Lepus alleni* Mearns) and blacktailed jackrabbits (*L. californicus* Gray) did not change with mesquite removal (McCormick 1975). Other studies were very general and simply presented anecdotal sightings of animals (Martin 1966).

Lagomorphs

Some of the earliest studies of lagomorphs were conducted at SRER (Vorhies and Taylor 1933) with the use of treatment and control areas. These early wildlife biologists recognized the importance of examining species in their habitat and understanding their value and relationships with humans. The importance of considering human dimensions as a critical component of wildlife management was raised by Leopold (1933), and Vorhies and Taylor

(1933). Human dimensions have been a central aspect of wildlife management ever since. As stated by Vorhies and Taylor (1933: 579), "This is wild life management." Their publication came out the same year Leopold (1933) published *Game Management*, and the monograph serves as a model for the scientific management Leopold (1933) advocated. Through their studies of lagomorphs, Vorhies and Taylor (1933) determined life history traits, distribution, interactions with livestock, forage consumption, diseases and parasites, censusing techniques, habitat relationships, predation, and management of antelope and blacktailed jackrabbits. Their monograph was one of the first in-depth studies of a game species conducted in the United States. Taylor and others (1935) also documented and demonstrated ways that jackrabbits influenced vegetation, and argued that wild animals should be considered in maintaining balanced rangelands.

Two studies followed Vorhies and Taylor (1933) that expanded on their work. Forage consumed by jackrabbits was determined from experimental trials (Arnold 1942: 46–69); jackrabbits consume as much as a 454-kg range cow consumes. Arnold and others (1943) also explored ways to estimate lagomorph numbers with counts of fecal pellets.

The second study examined the growth, development, and forage requirements of young California jackrabbits (Haskell and Reynolds 1947). These studies were conducted in a scientific manner, and the data are still useful today (Brown and Krausman 2003), primarily due to the scientific approach adopted by early wildlife biologists. Lagomorphs on SRER were also used as a model to study water balance and water requirements.

Early observations correlated moist diets as one mechanism to reduce dependency on free-standing water for the kangaroo rat (*Dipodomys spectabilis* Merriam), wood rat (*Neotoma albigula* Hartley), round-tailed ground squirrel (*Spermophilus tereticaudus* Baird), and jackrabbits (Vorhies 1945). Later, more detailed studies of the physiology of jackrabbits were conducted, which determined that jackrabbits reduced their dependency on free water in other ways: seeking shade, the insulation properties of their fur, use of a clear sky as a radiation heat sink during midafternoon (when solar and reflected radiation are reduced), high blood flow in the ears to permit heat loss, and development of a high lethal body temperature (45.4 °C) (Schmidt-Nielsen and others 1966). The survival techniques described by Schmidt-Nielsen and others (1966) were further applied to and studied for cottontails and jackrabbits (Hinds 1970). The study by Hinds (1970) only used animals captured at SRER; experimentation was conducted at the University of Arizona, Tucson.

Rodents

More work has been conducted on rodents at SRER than any other group of mammals. The studies ranged from notes to studies on ecology and life history traits.

Notes—The note (Taylor and Vorhies 1923) that was published described the capture of a pair of kangaroo rats. This was a time in the evolution of natural history writing where unusual observations were published regularly.

Abundance Indices—The Standard Minimum Method was a reliable technique to estimate small, nocturnal rodents at SRER, except it required large, homogeneous sample areas (7.3 ha) and large grids in addition to the assumptions that accommodate the technique. These drawbacks are time consuming (Olding 1976; Olding and Cockrum 1977), which preclude the method as a rapid technique suitable for estimating small rodents.

Breeding population density (per 2.6 km²) was tabulated for SRER for selected species by Leopold (1933: 233). Data for rodents were from Taylor (1930), but estimates for other species were subjectively estimated.

Physiology—Most of the physiological studies of rodents on SRER were related to water. Some heteromyid rodents conserve water through excretion of concentrated urine. Their maximum excretory ability (1,200 mN for electrolytes and 900 mN for chlorides) exceeds the limits for other mammals (K. Schmidt-Nielsen and others 1948). Other rodents such as white-throated woodrats cannot survive on dry food only, but solved the water problem by consuming succulent plants (B. Schmidt-Nielsen and others 1948).

Further studies demonstrated the importance of the humidity in rodent burrows to survival. The humidity in burrows of kangaroo rats was higher than outside humidity and significant for their water balance (Schmidt-Nielsen and Schmidt-Nielsen 1950a,b, 1951). These studies were some of the first that examined the water balance of desert mammals and are still widely cited.

More recent studies have examined the survival of small mammals from which blood was collected (Swann and others 1997). The survival of most rodents was not influenced due to anesthetization and bleeding through the orbital sinus. Pocket mice (*Chaetodipus* spp.) were the exception, and those that were bled had significantly lower survival rates compared to controls (Swann and others 1997).

Range Relations—Because of the economic value of SRER and its representation of desert grasslands in general, managers were interested in animals that competed with livestock for forage. One of the earliest studies was to determine how much forage kangaroo rats consumed (Vorhies and Taylor 1922). Unfortunately, they miscalculated and later revised their figures (Vorhies and Taylor 1924). Kangaroo rats consumed forage equivalent to 28 steers per year. However, because resources are often limited prior to summer rains, the forage destroyed by kangaroo rats would support 336 cattle in one month during this critical period (Vorhies and Taylor 1924). Because rodents have such an impact on range resources, it is important for managers to know how much they consume before establishing carrying capacity for livestock. Numerous methods to determine rodent pressure on rangelands were established, but how rodents interact with other aspects of rangeland ecology are unknown and need further research (for example, pressure on soil, relationship between rodents and insects) (Taylor 1930). Only limited research occurred in the past.

Merriam kangaroo rats were identified as an agent of mesquite propagation. When harvested, many seeds were buried that germinated and developed away from the parent tree. The result was an increase of mesquite at the expense of grasslands (Reynolds and Glendening 1949).

Some researchers recommended a reduction in kangaroo rats, along with livestock management to manage forage (Reynolds 1950; Reynolds and Glendening 1949). Merriam kangaroo rats consume large-seeded perennial grasses and other large seeds. When rangelands are in poor condition, rodents eat most seeds, which prevents rangeland restoration (Reynolds 1950). However, because other mammals also perpetuate an increase in mesquite and a decrease in grassland, removing kangaroo rats only would not increase grassland landscapes (Reynolds 1954). Additional forage studies of heteromyid rodents were conducted by Price (1977), and effects of woody removal on nocturnal rodents was examined by Vaughan (1976). Overall, as woody vegetation was removed, rodents were not effected, with few exceptions: kangaroo rats decreased and silky pocket mice (*Perognathus flavus* Baird) increased, as did others. Manipulation of vegetation for any reason needs to address how it will influence overall biodiversity.

The early studies on rodents were directed at basic traits and interactions with the grasslands. However, they also served to guide future research questions.

Ecology and Natural History—There was not a constant theme identified for the broad area of ecology and natural history. Studies conducted ranged from soils to disease and included abundance related to rainfall, dispersal and movements, behavior, life history, and habitat.

Despite the importance of rainfall to rodent populations, only two studies examined rodent abundance in relation to rainfall. Rainfall from 1942 to 1972 was correlated to the density of 10 rodents. Rodent fluctuation was predicted based on the amount of rainfall during the previous year (Turkowski and Vahle 1977). Petryszyn (1982) was able to correlate extreme rodent population fluctuations at SRER with certain El Niño events. Heteromyid rodent numbers increased over sixfold in just a few months in 1973. This pattern was repeated in 1979. Biomass of the Arizona pocket mouse (*Perognathus amplus* Benson) increased from less than 100 g per ha in May 1973 to over 1,100 g per ha by September 1973. The timing and amplitude of these increases varied among the rodent species. Petryszyn (University of Arizona, unpublished data) continued monitoring rodent populations at SRER until 1994, thus providing a 24-year record of rodent population fluctuations.

Rodent movements were contrasted in a control area and areas cleared of woody vegetation. Shifts in home range from clearing vegetation were made by adults primarily. However, the difference in movements or numbers of individual rodents (kangaroo rats, *Perognathus penicillatus*, southern grasshopper mouse [*Onychomys torridus* Coves]) on disturbed and undisturbed areas was minor (Vaughan 1972). A short removal study (to determine how trapping affected rodents) most frequently captured the same three rodent species. Results were inconclusive (Courtney 1971). Additional removal studies were conducted (Courtney 1983), but removal did not influence home range size or physiology of kangaroo rats.

Studies on behavior were also limited. One dissertation was conducted on predatory behavior of the southern grasshopper mouse (Langley 1978). The southern grasshopper mouse learned how to kill different prey (for example, crickets, stink beetles, scorpions) based on their defenses (Langley 1981).

Because so little was known about the life history of many rodents, some of the earlier studies at SRER concentrated on establishing a basis of knowledge for several rodents. Early researchers were also interested in how rodents influenced rangelands.

Classical life history accounts (for example, status, taxonomy, range, periods of activity, breeding, habitat, diet, predation, economics, management) were provided for woodrats (Vorhies and Taylor 1940), Sonoran Desert pocket mouse (*Chaetodipus penicillatus pricei* Allen), Bailey's pocket mouse (*C. baileyi baileyi* Merriam), and Merriam's kangaroo rats (Reynolds 1958, 1960). There was no impact to rangelands from pocket mice or woodrats. Merriam's kangaroo rats were more abundant on rangelands grazed by livestock, and they are likely beneficial by burying seeds. However, they also bury mesquite and cactus seeds, which is not always favorable to range management objectives (Reynolds 1958).

Studies of habitat have been limited. Competition was examined as a mechanism for rodents to use different microhabitats for foraging (Price 1976, 1978). Similar results (for example, habitat selection as an important factor in species coexistence) were reported by Wondolleck (1975, 1978). Price and others (1984) also demonstrated that rodents spent less time in open areas on moonlit nights than on dark nights. Langley (1980) described habitat (such as burrowweed, a few grasses, and bare soil) for southern grasshopper mice at SRER. More recently, the habitat use and abundance of rodents at SRER was documented. These data revealed temporal and age-related differences in habitat use by rodents, which are of use in fine-scale planning for restoration of desert plant communities (Morrison and others 2002). Gottesman (2002) studied the habitat use and movement patterns of rodents in riparian vegetation and concluded that most animals made only short-distance movements. Although the papers on habitat were limited, they ranged from basic habitat requirements to brief discussions of habitat alteration and restoration.

Three studies addressed the response of soils to animal activity at SRER: Greene and Murphy (1932); Greene and Reynard (1932); and Taylor (1935). All were very general but pointed to the importance of physical and chemical changes animals caused in the soil. No other studies were found that addressed the influence of wildlife on soil.

Some of the more recent work with rodents at SRER has examined Sin Nombre virus prevalence. Thirteen species were captured and examined, but only mice in the genus *Peromyscus* were seropositive for the virus. There was a suggested correlation between population size and hantavirus-antibody prevalence (Kuenzi and others 1999).

Predators

In the 1970s and early 1980s a series of studies on coyotes was conducted at SRER. Home ranges (54 to 77 km² for juveniles), abundance, and behavior were documented (Danner 1976; Danner and Smith 1980). During these studies Danner and Fisher (1977) were the first to document homing by a marked coyote.

More detailed studies of coyotes were conducted at SRER by Drewek (1980) and Fisher (1980). Drewek (1980) examined home ranges, activity patterns, and age distribution.

Fisher (1980) examined how an abundant food source (such as carrion) influenced density, age distribution, weights, ovulation rates, and litter sizes of coyotes in three study areas (no differences). Other diet studies were also conducted (Short 1979).

Ungulates

Collared peccaries and deer received some attention at SRER. Collared peccary diets were examined and were found not to be competitive for forage with livestock (Eddy 1959, 1961). General life history data were also presented (Knipe 1957). Home ranges and movements of five mule deer were examined (Rodgers 1977; Rodgers and others 1978). These researchers concluded that disturbances by humans influenced breeding activity and normal movement patterns.

Feeding trials for Coues white-tailed deer (*Odocoileus virginianus* Coues) were conducted at SRER (Nichol 1936, 1938). Nichol (1938) also examined parasites, disease, water and salt consumption, reproductive patterns, and hybridization of mule deer and white-tailed deer. The study was initiated because the U.S. Forest Service was interested in appropriate allocation for livestock and wildlife, a controversy that still continues in Arizona. This was one of the first studies addressing these topics in Arizona, and the work is still used as a reference.

Despite the importance of deer to Arizona, including hunting, no studies were found that examined harvests in SRER. Some summary data were provided in a memo (Yeager and Martin 1965; not seen, cited in Medina (1996) (hunt success) for the 1964 deer season.

This array of research has been instrumental in establishing SRER as the natural laboratory it was designed to be. However, scientists and administrators could be more efficient with a directed approach for long-term research that include inventory and monitoring. To our knowledge, the U.S. Department of Agriculture's Forest Service or the University of Arizona administrators have not allocated funds or a central mission in which continuous studies of wildlife could be conducted. Unless a central theme or funding level is established, wildlife research at SRER will continue to be based on individual efforts.

Inventory and Monitoring _____

Inventory and monitoring are the most frequently conducted type of wildlife studies (Morrison and others 2002). They are done to gather new knowledge about an area, quantify trends in some animal or resource of interest, and to assist with resource management. The goal of an inventory is to quantify the current composition, distribution, and perhaps abundance of a species of interest in an area. Monitoring is simply conducting repeated inventories to quantify changes in composition, distribution, and abundance over time. In addition to the general pursuit of knowledge, inventory and especially monitoring are often mandated by legislation, such as by the National Forest Management Act (1976) and the Endangered Species Act (1973). Unfortunately, both initial inventories and followup monitoring are seldom conducted with sufficient rigor to

precisely estimate the parameters of interest (Morrison and Marcot 1995; Morrison and others 2002).

There are numerous reasons why establishing an organized and rigorous inventory and monitoring program would benefit an education and research mission at SRER. First, resource managers need to have reliable data upon which decisions can be based. Only a comprehensive monitoring program that involves all taxa can hope to provide an understanding of the interactions between management decisions and wildlife responses. Second, there is the need to provide students and potential researchers with a complete list of species composition, relative abundances, and distribution to assist with teaching and research planning. Third, the University of Arizona and the Forest Service should have an interest in monitoring the influence of local, regional, and global changes in climate, air quality, human population impacts, and other factors on wildlife populations over time.

Simply establishing a series of repeated sampling locations (regardless of the specific methodologies used) is insufficient, however, to address any questions regarding wildlife at SRER in a meaningful way. Specific and quantifiable objectives must be established before successful monitoring can be accomplished; these objectives then drive the sampling design, intensity of sampling, and statistical analyses. A typical goal of monitoring is to identify trends in a resource of interest. Trends represent the sustained patterns in count data that occur independently of cycles, seasonal variations, and irregular fluctuations in counts. A common problem in trend detection, however, is that sources of "noise" in counts obscure the "signal" associated with ongoing trends. The probability that a monitoring program will detect a trend in sample counts when the trend is occurring, despite the "noise" in the count data, represents its statistical power. Although statistical power is central to every monitoring effort, it is rarely assessed. Consequences of ignoring it include collection of count data insufficient to make reliable inferences about population trends, and collection of data in excess of what is needed (Gibbs 1995).

The statistical power of population monitoring programs must be estimated relative to (1) the number of plots monitored, (2) the magnitude of counts per plot, (3) count variation, (4) plot weighting schemes, (5) the duration of monitoring, (6) the interval of monitoring, (7) the magnitude and nature of ongoing population trends, and (8) the significance level associated with trend detection (Gibbs 1995). Because these factors interact in complex ways to determine the capacity of a monitoring program to detect trends in populations, such basic questions of "how many plots should I monitor" or "how often should I conduct surveys" rarely have intuitive answers. Programs such as **MONITOR** (Gibbs 1995) are designed to explore interactions among the many components of monitoring programs and to evaluate how each component influences the monitoring program's power to detect trends.

In general and certainly applicable to SRER, broad objectives for conducting monitoring are (Spellerberg 1991) to:

1. Provide guidance to wildlife management and conservation.
2. Better integrate wildlife conservation and management with other land uses.
3. Advance basic knowledge in addition to applied knowledge.

4. Track potential problems before they become real problems.

These objectives are often addressed by conducting monitoring studies (Gray and others 1996; Miller 1996) to:

1. Determine wildlife use of a particular resources or area.
2. Evaluate effects of land use on populations or habitats.
3. Measure changes in population parameters.
4. Evaluate success of predictive models.
5. Assess faunal changes over time.

Monitoring Elements

Key components of a monitoring program at SRER should include the:

1. Ability to link past, current, and any future research activities with a systematic grid system (in other words, to be able to locate relative to base monitoring sampling frame).
2. Sampling frame developed around an attribute-based GIS vegetation system.
3. Sampling protocol for rare species, such as adaptive cluster sampling, to be instituted in addition to the basic sampling frame.

For example, a 500- by 500-m grid coordinate system could be established across SRER. This spacing would be applicable for implementing a standard point-count methodology for birds because most counting protocols require an interpoint spacing of greater than or equal to 300 m. The actual spacing of grid points is actually irrelevant because the system would only exist as coordinates in a GIS layer and not physically exist on the ground. Using the 500- by 500-m spacing and beginning at a random starting point in one corner of SRER, points would be systematically spread across the area. Additional points would also be randomly placed within each currently recognized vegetation type, while ensuring that adequate sampling occurred in rare types. For example, additional (nongrid) points would need to be established in linear (for example, riparian) and relatively small (for example, hackberry [*Celtis reticulata*] woodland) types. A systematic placement of grid points is recommended because there is no assurance that a currently recognized classification of vegetation would be of adequate refinement for many applications, or that the classification would be stable into the future. It is likely, however, that certain vegetation classifications (for example, riparian, the major plant associations currently recognized) will remain adequate upon which to base the general allocation of points. The value of points is that they are readily locatable using GPS, even if they serve as the starting point of a transect.

The number of points to be sampled should be based on power analysis using the best available estimates of variance associated with each parameter of interest. It is important to recognize that power analysis only provides an initial estimate of sample size. The final sampling effort must be based on an iterative process that updates the number of required samples as data are gathered. Power analysis requires that a magnitude of biological effect be established. That is, what magnitude of change must be quantified with what level of certainty? For example, is it sufficient for SRER

resource managers to be able to identify a 5 percent annual change in abundance of a species in 3 years, or can they wait to identify this change over 5 years? The answer will vary depending on the species in question. Note that allowing for a 5 percent decline in abundance over 5 years results in a cumulative loss of 29 percent—a substantial decline for any species.

Unfortunately, very little general guidance is in the literature regarding appropriate initial sample sizes for a large-scale, multispecies monitoring program. This is due, in part, to the rather recent general interest in statistical rigor being shown among many wildlife professionals. However, many computer statistical packages are now available that allow easy access to power analyses. Because there are so many potential criteria that can appropriately be used for establishing monitoring parameters, and because the rarer species will require specialized sampling efforts, we cannot provide a cookbook answer for necessary sample sizes. Some studies on monitoring relatively common bird species have shown, however, that 30 to 50 points (usually counted 3 times each per season, most often in the breeding season) are adequate to detect a 5 percent annual change in abundance within a 5-year period. At SRER, however, it will not be possible to place that many points within relatively rare vegetative types or plant associations. In such situations, it becomes necessary to increase sampling intensity, and conduct a more intensive type of monitoring, to rigorously quantify change. With birds, for example, researchers often supplement point counts with more intensive spot mapping procedures.

Rare Species

Management recommendations are sometimes made for rare species based on data from common species, although rare species are excluded from analyses due to small sample sizes. In many cases, threatened or endangered species are “rare.” If a species only occurs in a very specialized habitat, it would be rare in that its only detections occur within spatially clumped areas. Alternatively, if a species has a large geographic range it may be considered rare because it is only detected during a community assessment as it wanders through a study area. Lastly, species are considered rare when local populations are composed of a few individuals per unit area, as is the case with most threatened and endangered species (Queheillalt and others 2002).

Due to the great number of “rare” species in plant and animal communities, these communities are known to adhere to lognormal species abundance distributions, in which a small number of species are common, only a few species reside in intermediate to low numbers, and most are uncommon (Harte and others 1999; Maina and Howe 2000; Rosenberg and others 1995; Van Auken 1997). Frequently used sampling designs, such as simple random sampling, stratified random sampling, and systematic random sampling, are ineffective when applied to infrequently encountered species, and such sampling designs return numerous zero counts and decrease the accuracy of the studies using these designs (Thompson 1992; Thompson and others 1998).

The exclusion of species due to low detection rates leads to the erroneous inflation of relative abundance and density calculations of included species. In instances of special

status species (for example, legally threatened or endangered), elevated density estimates may lead to the biological notion that a species is prevalent in sufficient numbers when in fact its actual density is low. Also, if the object of the study is to compare relative abundances over successive years, trends may appear for a species, which are due to the number of species excluded from abundance calculations rather than true biological trends.

Because rare species are often spatially clumped, we recommend using one of the forms of adaptive sampling methods—adaptive cluster sampling design, strip adaptive cluster sampling, or stratified adaptive cluster sampling—as described by Thompson (1992) to supplement the systematic arrangement of sampling points described above. Adaptive cluster sampling is a two-stage sampling design in which initial sampling plots are randomly selected and monitored. Any of the initial plots containing animals are selected to have all adjacent plots monitored as well. This process continues until adjacent plots no longer contain animals of interest (Krebs 1999; Morrison and others 2001; Thompson 1992). This method increases the probability of encountering clumped species, and thus often increases sample sizes.

Statistical analyses with small sample sizes can be problematic. When samples are from highly variable populations, statistical analyses often have low power. Although beyond the scope of this paper, there are options for statistical analyses with small sample sizes. Contingent upon the specific situation and type of data being used, nonparametric tests can be employed or data transformed to allow the use of parametric tests when working with small sample sizes.

References

- Arnold, J. F. 1942. Forage consumption and preferences of experimentally-fed Arizona and antelope jack rabbits. Tucson: University of Arizona. Arizona Agricultural Experiment Station Technical Bulletin. 98: 51–86.
- Arnold, J. F.; Reynolds, H. G. 1943. Droppings of Arizona and antelope jackrabbits and the “pellet census.” *Journal of Wildlife Management*. 7(3): 322–327.
- Brown, C. F.; Krausman, P. R. 2003. Habitat characteristics of 3 leporid species in southeastern Arizona. *Journal of Wildlife Management*. 67(1): 83–89.
- Calder, W. A. 1968a. The diurnal activity of the roadrunner, *Geococcyx californianus*. *Condor*. 70(1): 84–85.
- Calder, W. A. 1968b. There really is a roadrunner. *Natural History*. 77: 50–55.
- Courtney, M. W. 1971. Effects of removal on movements within populations of nocturnal desert rodents. Tucson: University of Arizona. 32 p. Thesis.
- Courtney, M. W. 1983. Effects of reduced interspecific interactions on population dynamics in Merriam's kangaroo rat, *Dipodomys merriami*. Tucson: University of Arizona. 73 p. Dissertation.
- Danner, D. A. 1976. Coyote home range, social organization, and scent post visitation. Tucson: University of Arizona. 86 p. Thesis.
- Danner, D. A.; Fisher, A. R. 1977. Evidence of homing by a coyote (*Canis latrans*). *Journal of Mammalogy*. 58(2): 244–245.
- Danner, D. A.; Smith, N. S. 1980. Coyote home range, movement, and relative abundance near a cattle feed yard. *Journal of Wildlife Management*. 44(2): 484–487.
- Drewek, J., Jr. 1980. Behavior, population structure, parasitism, and other aspects of coyote ecology in southern Arizona. Tucson: University of Arizona. 261 p. Dissertation.
- Eddy, T. A. 1959. Foods of the collared peccary *Pecari tajacu sonoriensis* (Mearns) in southern Arizona. Tucson: University of Arizona. 102 p. Thesis.
- Eddy, T. A. 1961. Foods and feeding patterns of the collared peccary in southern Arizona. *Journal of Wildlife Management*. 25(3): 248–257.
- Fisher, A. R. 1980. Influence of an abundant supply of carrion on population parameters of the coyote. Tucson: University of Arizona. 80 p. Dissertation.
- Germano, D. J.; Hungerford, C. R. 1981. Reptile population changes with manipulation of Sonoran desert scrub. *Great Basin Naturalist*. 41(1): 129–138.
- Germano, D. S. 1978. Response of selected wildlife to mesquite removal in desert grassland. Tucson: University of Arizona. 60 p. Thesis.
- Gibbs, J. P. 1995. Monitor: software for estimating the power of population monitoring programs to detect trends in plant and animal abundance. Users manual, version 6.3. New Haven, CT: Yale University, Department of Biology.
- Gorsuch, D. M. 1934. Life history of the Gambel quail in Arizona. Tucson: University of Arizona. *Biological Science Bulletin*. 2: 1–89.
- Gottesman, A. B. 2002. Movements and habitat use of the brush mouse. Tucson: University of Arizona. 50 p. Thesis.
- Green, R. H.; Young, R. C. 1993. Sampling to detect rare species. *Ecological Applications*. 3(2): 351–356.
- Greene, R. A.; Murphy, G. H. 1932. The influence of two burrowing rodents, *Dipodomys spectabilis spectabilis* (kangaroo rat) and *Neotoma albigula albigula* (pack rat), on desert soils in Arizona. II. Physical effects. *Ecology*. 13(4): 359–363.
- Greene, R. A.; Reynard, C. 1932. The influence of two burrowing rodents, *Dipodomys spectabilis spectabilis* (kangaroo rat) and *Neotoma albigula albigula* (pack rat), on desert soils in Arizona. *Ecology*. 13(1): 73–80.
- Grinnell, J. 1927. A critical factor in the existence of Southwestern game birds. *Science*. lxxvi: 528–529.
- Harte, J.; Kinzig, A.; Green, G. 1999. Self-similarity in the distribution and abundance of species. *Science*. 284(5412): 334–336.
- Haskell, H. S.; Reynolds, H. G. 1947. Growth, developmental food requirements, and breeding activity of the California jack rabbit. *Journal of Mammalogy*. 28(2): 129–136.
- Hinds, D. S. 1970. A comparative study of thermoregulation and water balance in hares and rabbits of the Sonoran Desert. Tucson: University of Arizona. 145 p. Dissertation.
- Humphrey, R. R. 1936. Notes on altitudinal distribution of rattlesnakes. *Ecology*. 17(2): 328–329.
- Hungerford, C. R. 1960a. The factors affecting the breeding of Gambel's quail *Lophortyx gambelii gambelii* Gambel in Arizona. Tucson: University of Arizona. 94 p. Dissertation.
- Hungerford, C. R. 1960b. Water requirements of Gambel's quail. North American Wildlife Conference. 25: 231–240.
- Hungerford, C. R. 1962. Adaptations shown in selection of food by Gambel quail. *Condor*. 64(3): 213–219.
- Hungerford, C. R. 1964. Vitamin A and productivity in Gambel's quail. *Journal of Wildlife Management*. 28: 141–147.
- Kuenzi, A. J.; Morrison, M. I.; Swann, D. E.; Hardy, P. C.; Downard, G. T. 1999. A longitudinal study of Sin Nombre virus prevalence in rodents, southeastern Arizona. *Emerging Infectious Diseases*. 5(1): 113–117.
- Knipe, T. 1957. Javelina in Arizona. Phoenix: Arizona Game and Fish Department. *Wildlife Bulletin*. 2: 1–96.
- Langley, W. 1980. Habitat preferences of *Onchomys Torridus* (Muridae) in a desert grassland. *Southwestern Naturalist*. 25(2): 266–267.
- Langley, W. 1978. The development of predatory behavior in *Onchomys Torridus* (Coves). Tempe: Arizona State University. 170 p. Dissertation.
- Langley, W. 1981. The effect of prey defenses on the attack behavior of the southern grasshopper mouse (*Onchomys Torridus*). *Z. Tierpsychology*. 56(2): 115–127.
- Leopold, A. 1933. *Game Management*. New York: Charles Scribner's Sons. 481 p.
- MacGregor, W. 1953. An evaluation of California quail management. *Western Association of State Game and Fish Commissioners*. 33: 157–160.
- Maina, G. G.; Howe, H. F. 2000. Inherent rarity in community restoration. *Conservation Biology*. 14(5): 1335–1340.
- Martin, S. C. 1966. Will you see any game today? *Progressive Agriculture in Arizona*. 18(4): 30–31.

- McCormick, D. P. 1975. Effect of mesquite control on small game populations. Tucson: University of Arizona. 66 p. Thesis.
- Medina, A. L. 1988. Diets of scaled quail in southern Arizona. *Journal of Wildlife Management*. 52(4): 753–757.
- Medina, A. L. 1996. The Santa Rita Experimental Range: history and annotated bibliography (1903–1988). Gen. Tech. Rep. RM-GTR-276. Fort Collins, CO: U.S. Department of Agriculture, Forest Service, Rocky Mountain Forest and Range Experiment Station. 67 p.
- Morrison, M. L.; Block, W. M.; Strickland, M. D.; Kendall, W. L. 2001. Wildlife study design. New York: Springer-Verlag. 210 p.
- Morrison, M. L.; Kuenzi, A. J.; Brown, C. F.; Swann, D. E. 2002. Habitat use and abundance trends of rodents in southeastern Arizona. *Southwestern Naturalist*. 47(4): 519–526.
- Morrison, M. L.; Marcot, B. G. 1995. An evaluation of resource inventory and monitoring programs used in National Forest planning. *Environmental Management*. 19(1): 147–156.
- Nichol, A. A. 1938. Experimental feeding of deer. Tucson: University of Arizona. Arizona Agricultural Experiment Station Technical Bulletin. 75: 1–39.
- Nichol, A. A. 1936. The experimental feeding of deer. *Transactions of the North American Wildlife Conference*. 1: 403–410.
- Olding, R. J., Jr. 1976. Estimation of desert rodent populations by intensive removal. Tucson: University of Arizona. 60 p. Thesis.
- Olding, R. J.; Cockrum, E. L. 1977. Estimation of desert rodent populations by intensive removal. *Journal of the Arizona Academy of Science*. 12: 94–108.
- Petryszyn, Y. 1982. Population dynamics of nocturnal desert rodents: a nine year study. Tucson: University of Arizona. 108 p. Dissertation.
- Price, M. V. 1976. The role of microhabitat in structuring desert rodent communities. Tucson: University of Arizona. 72 p. Dissertation.
- Price, M. V. 1977. Validity of live trapping as a measure of foraging activity of Heteromyid rodents. *Journal of Mammalogy*. 58(1): 107–110.
- Price, M. V. 1978. The role of microhabitat in structuring desert rodent communities. *Ecology*. 59(5): 910–921.
- Price, M. V.; Nickolas, M. W.; Bass, T. A. 1984. Effects of moonlight on microhabitat use by desert rodents. *Journal of Mammalogy*. 65(2): 353–356.
- Queheillalt, D. M.; Cain, J. W., III; Taylor, D. E.; Morrison, M. L.; Hoover, S. L.; Tuatoo-Bartley, N.; Ruge, L.; Christopherson, K.; Hulst, M. D.; Harris, M. R.; Keough, H. L. 2002. The exclusion of rare species from community-level analyses. *Wildlife Society Bulletin*. 30(3): 756–759.
- Reynolds, H. G. 1950. Relation of Merriam kangaroo rats to range vegetation in southern Arizona. *Ecology*. 31(3): 456–463.
- Reynolds, H. G. 1954. Some interrelations of the Merriam kangaroo rat to velvet mesquite. *Journal of Range Management*. 7(4): 176–180.
- Reynolds, H. G. 1958. The ecology of the Merriam kangaroo rat (*Dipodomys merriami* Mearns) on the grazing lands of southern Arizona. *Ecological Monographs*. 28(2): 111–127.
- Reynolds, H. G. 1960. Life history notes on Merriam's kangaroo rat in southern Arizona. *Journal of Mammalogy*. 41(1): 48–58.
- Reynolds, H. G.; Glendening, G. E. 1949. Merriam kangaroo rat a factor in mesquite propagation on southern Arizona range lands. *Journal of Range Management*. 2(4): 193–197.
- Reynolds, H. G.; Haskell, H. S. 1949. Life history notes on Price and Bailey pocket mice of southern Arizona. *Journal of Mammalogy*. 30(2): 150–156.
- Rodgers, K. J. 1977. Seasonal movement of mule deer on the Santa Rita Experimental Range. Tucson: University of Arizona. 63 p. Thesis.
- Rodgers, K. J.; Ffolliott, P. F.; Patton, D. R. 1978. Home range and movement of five mule deer in a semidesert grass-shrub community. Res. Note. RM-355. Fort Collins, CO: U.S. Department of Agriculture, Forest Service, Rocky Mountain Forest and Range Experiment Station. 6 p.
- Rosenberg, D. K.; Overton, W. S.; Anthony, R. G. 1995. Estimation of animal abundance when capture probabilities are low and heterogeneous. *Journal of Wildlife Management*. 59(2): 252–261.
- Rosenstock, S. S.; Ballard, W. B.; deVos, J. C., Jr. 1999. Benefits and impacts of wildlife water developments. *Journal of Range Management*. 52(4): 302–311.
- Russell, S. M.; Gould, J. P. 1974. Population structure, foraging behavior, and daily movements of certain Sonoran Desert birds. U.S. International Biological Program. Desert Biome Research Memorandum 74-27. 3: 129–135.
- Russell, S. M.; Gould, P. J.; Smith, E. L. 1973. Population structure, foraging behavior and daily movements of certain Sonoran Desert birds. U.S. International Biological Program. Desert Biome Research Memorandum 73-27. 3: 2.3.2.10.-1–2.3.2.10-20.
- Russell, S.; Smith, E.; Gould, P.; Austin, G. 1972. Studies on Sonoran birds. U.S. International Biological Program. Desert Biome Research Memorandum 72-31. 2.3.2.7.-1–2.3.2.7.-13.
- Schmidt-Nielsen, B.; Schmidt-Nielsen, K. 1950a. Evaporative water loss in desert rodents in their natural habitat. *Ecology*. 31(1): 75–85.
- Schmidt-Nielsen, B.; Schmidt-Nielsen, K. 1950b. Pulmonary water loss in desert rodents. *American Journal of Physiology*. 162(1): 31–36.
- Schmidt-Nielsen, B.; Schmidt-Nielsen, K. 1951. A complete account of the water metabolism in kangaroo rats and an experimental verification. *Journal of Cellular and Comparative Physiology*. 38(2): 165–181.
- Schmidt-Nielsen, B.; Schmidt-Nielsen, K.; Brokaw, A.; Schneiderman, H. 1948. Water conservation in desert rodents. *Journal of Cellular and Comparative Physiology*. 32(3): 331–360.
- Schmidt-Nielsen, K.; Dawson, T. J.; Hammel, H. T.; Hinds, D.; Jackson, D. C. 1966. The jack-rabbit—a study in its desert survival. *Hvalradets Skrifter*. 48: 125–142.
- Schmidt-Nielsen, K.; Schmidt-Nielsen, B.; Schneiderman, H. 1948. Salt excretion in desert mammals. *The American Journal of Physiology*. 154(1): 163–166.
- Short, H. L. 1979. Food habits of coyotes in a semidesert grass-shrub habitat. Res. Note RM-364. Fort Collins, CO: U.S. Department of Agriculture, Forest Service, Rocky Mountain Forest and Range Experiment Station. 4 p.
- Spellerberg, I. F. 1991. Monitoring ecological change. New York: Cambridge University Press. 334 p.
- Swann, D. E.; Kuenzi, A. J.; Morrison, M. L.; DeStefano, S. 1997. Effects of sampling blood on survival of small mammals. *Journal of Mammalogy*. 78(3): 909–913.
- Taylor, W. P. 1930. Methods of determining rodent pressure on the range. *Ecology*. 11(3): 523–542.
- Taylor, W. P. 1935. Some animal relations to soils. *Ecology*. 16(2): 127–136.
- Taylor, W. P.; Vorhies, C. T. 1923. Kangaroo rats and scorpion mice on the Santa Rita Reserve, Arizona. *Journal of Mammalogy*. 4(4): 255.
- Taylor, W. P.; Vorhies, C. T.; Lister, P. B. 1935. The relation of jack rabbits to grazing in southern Arizona. *Journal of Forestry*. 33(5): 490–498.
- Thompson, S. K. 1990. Adaptive cluster sampling. *Journal of the American Statistical Association*. 85(412): 1050–1059.
- Thompson, S. K. 1991b. Adaptive cluster sampling: designs with primary and secondary units. *Biometrics*. 47(3): 1103–1115.
- Thompson, S. K. 1991a. Stratified adaptive cluster sampling. *Biometrika*. 78(2): 389–397.
- Thompson, S. K. 1992. *Sampling*. New York: John Wiley & Sons, Inc. 367 p.
- Thompson, W. L.; White, G. C.; Gowan, C. 1998. *Monitoring vertebrate populations*. San Diego, CA: Academic Press. 365 p.
- Turkowski, F. J.; Vahle, J. R. 1977. Desert rodent abundance in southern Arizona in relation to rainfall. Res. Note RM-346. Fort Collins, CO: U.S. Department of Agriculture, Forest Service, Rocky Mountain Forest and Range Experiment Station. 4 p.
- Van Auken, O. W. 1997. Species rareness and commonness along spatial and temporal gradients. *The Southwestern Naturalist*. 42(4): 369–374.
- Vaughan, P. J. 1972. Dispersal in a small mammal population. Tucson: University of Arizona. 61 p. Thesis.
- Vaughan, T. C. 1976. Effects of woody vegetation removal on rodent populations at Santa Rita Experimental Range, Arizona. Tucson: University of Arizona. 95 p. Dissertation.
- Vorhies, C. T. 1928. Do Southwestern quail require water? *American Naturalist*. 682: 446–452.
- Vorhies, C. T. 1932. First record of the pectoral sandpiper for Arizona. *The Condor*. 34(1): 46–47.

- Vorhies, C. T. 1945. Water requirements of desert animals in the Southwest. Tucson: University of Arizona. Arizona Agricultural Experiment Station Technical Bulletin. 107: 487–525.
- Vorhies, C. T.; Taylor, W. P. 1922. Life history of the kangaroo rat, *Dipodomys spectabilis spectabilis* Merriam. Bull. 1091. Washington, DC, U.S. Department of Agriculture. 40 p.
- Vorhies, C. T.; Taylor, W. P. 1924. Damage by kangaroo rats. *Journal of Mammalogy*. 5(2): 144.
- Vorhies, C. T.; Taylor, W. P. 1933. The life histories and ecology of jack rabbits, *Lepus alleni* and *Lepus californicus* ssp., in relation to grazing in Arizona. Tucson: University of Arizona. Arizona Agricultural Experiment Station Technical Bulletin. 49: 471–587.
- Vorhies, C. T.; Taylor, W. P. 1940. Life history and ecology of the white-throated wood rat, *Neotoma albigula albigula* Hartley, in relation to grazing in Arizona. Tucson: University of Arizona. Arizona Agricultural Experiment Station Technical Bulletin. 86: 455–529.
- Wondolleck, J. T. 1978. Forage-area separation and overlap in heteromyid rodents. *Journal of Mammalogy*. 59(3): 510–518.
- Wondolleck, J. T. 1975. The influence of interspecific interactions on the forage areas of heteromyid rodents. Tucson: University of Arizona. 35 p. Thesis.
- Yeager, M.; Martin, S. C. 1965. Results of 1964 deer hunt on the Santa Rita Experimental Range. Tempe, AZ: U.S. Department of Agriculture, Forest Service, Rocky Mountain Forest and Range Experiment Station, and Arizona Game and Fish Department. 18 p. [Mimeo. Not seen]. Cited in Medina 1996.

Cultural Resources of the Santa Rita Experimental Range

Abstract: The Santa Rita Experimental Range is a vast open space with few signs of houses or human habitation, but at one time it was quite the opposite scene. Archaeological surface inspections reveal heavy use of the Range dating back hundreds of years. This paper will review the history of cultural resource management on the Range and provide a timeline of local cultural history pertinent to understanding the cultural landscape on the west flank of the Santa Rita Mountains. An archaeological site inventory done by Cynthia Buttery in 1985 and 1986 will be the central focus of this paper. Buttery's work provides an important picture of land use on the Range over 800 years ago by Hohokam farmers. The paper will conclude with comments on cultural resource management and research opportunities on the Santa Rita Experimental Range.

Introduction

This paper will address the history of cultural resource management on the Santa Rita Experimental Range (SREER or the Range) and will provide a summary of how the land was used by American Indians prior to European contact in the late 1690s. The paper will conclude with a summary of potential strategies to protect and preserve cultural resources on the Range and a view of how we might blend the environmental information found in prehistoric sites with more traditional range-oriented research themes.

Historic Preservation Policy Applicable to Santa Rita

Two Federal laws set the stage for cultural resource management on the Santa Rita Experimental Range. The Archaeological and Historic Preservation Act of 1960 (AHPA) (Public Law 86-523, 16 U.S.C. 468–469c-2) was adopted to further improve the intent of the Historic Sites Act of 1935 (16 USC 461–467). The intent of AHPA is to preserve historic American sites, buildings, objects, and antiquities of national significance. The Act provides for the protection of historical and archaeological data (including relics and specimens), which might be irreparably lost or destroyed as a result of alterations to the land caused by a Federal agency or a Federally licensed construction project.

The second law of importance was the National Historic Preservation Act (16 USC 470 *et seq.*). Enacted in 1966, this Act provides for a National Register of Historic Places, and has broad authority over national, State, and local historic preservation programs. Section 110 of the Act has had the most significant impact on the Range.

Section 110 directs the heads of Federal agencies to assume responsibility for the preservation of National Register listed or eligible historic properties owned or controlled by their agency. Agencies are directed to locate, inventory, and nominate properties to the National Register, to exercise caution to protect such properties, and to use such properties to the maximum extent feasible. Other major provisions of Section 110 include documentation of properties adversely affected by Federal undertakings and the establishment of trained Federal preservation officers in each agency.

After the passage of the National Historic Preservation Act, Federal agencies with land managing responsibilities began to fill their ranks with cultural resource managers. The Santa Rita Experimental Forest, as it was called in the 1960s, fell into a unique Federal land category. Because the land was not within the boundaries of a National Forest, it was identified as “other Federal lands” and was administered by the Bureau of Land Management (BLM). The USDA Forest Service Rocky Mountain Forest and Range Experiment Station managed the surface of the land through an interagency agreement with the BLM.

Management of cultural resources on the experimental range was shared between the Coronado National Forest and the Rocky Mountain Forest and Range Experiment Station. Little was known about the cultural resources before 1974. The Coronado National Forest employed its first Forest Archaeologist by 1975. Personnel at the Station, in cooperation with the

John H. Madsen is an Associate Curator of Archaeology at the Arizona State Museum, P.O. Box 210026, University of Arizona, Tucson, AZ 85721; e-mail: jmadsen@u.arizona.edu. He has a B.S. degree in environmental studies and an M.A. degree in archaeology from California State University, Sacramento.

In: McClaran, Mitchel P.; Ffolliott, Peter F.; Edminster, Carleton B., tech. coords. Santa Rita Experimental Range: 100 years (1903 to 2003) of accomplishments and contributions; conference proceedings; 2003 October 30–November 1; Tucson, AZ. Proc. RMRS-P-30. Ogden, UT: U.S. Department of Agriculture, Forest Service, Rocky Mountain Research Station.

Forest Archaeologist, conducted cultural resource inspection on SRER in advance of ground alterations related to fence installations, buried pipelines to livestock water supplies, and road maintenance.

In the 1980s opportunities arose to place large blocks of sensitive habitat in south-central Pima County under the jurisdiction of the U.S. Fish and Wildlife Service. In an elaborate exchange that involved land from several agencies including the U.S. Forest Service, BLM, and U.S. Fish and Wildlife Service, the Range was transferred to the State of Arizona in 1990. Today the Santa Rita Experimental Range is administered by the Arizona State Land Department and leased to the University of Arizona for ecological and ranch lands research.

Land management responsibilities for SRER now fall to the Arizona State Land Department and their lessee, the University of Arizona. National historic preservation policy applies to SRER when Federally funded or licensed projects or Federally funded grants are used in a way that might impact cultural resources. In such instances the Arizona State Historic Preservation Office in consultation with the funding or licensing agencies, the recipient of the funds or license, and other interested parties, such as Arizona Tribes, assure compliance with Federal legislation.

Two State laws now serve to protect and preserve the prehistoric, historic, and paleontological resources within the boundaries of the Experimental Range during the normal course of daily operations and management, and during State and privately financed research. The first of these laws is the Arizona State Historic Preservation Act of 1982 (Title 41, Chapter 4.2 Historic Preservation, Article 4, General Provisions, A.R.S. Sec. 41-861 through 864). This State law and its associated policies are administered in part by the Arizona State Historic Preservation Office and guide land-managing agencies and institutions like the University of Arizona through their responsibilities to protect and preserve cultural resources on lands they own or control.

The second State law pertaining to SRER is often referred to as the Arizona Antiquities Act, but in actuality is Title 41, Chapter 4.1 Article 4, Archaeological Discoveries (A.R.S. Sec. 41-841 *et seq.*). The University of Arizona has a long and honored role in the implementation of this law. In 1927, the Arizona Eight Legislature enacted the first law to regulate excavation of prehistoric ruins on State and Federal lands in Arizona through a permit system. The legislature assigned the task of administering this statute to the University of Arizona, Department of Anthropology. The Department administered the Act until 1960 when amendments placed administration of the law under the Arizona Board of Regents and the Director of the Arizona State Museum, University of Arizona (ASM).

The intent of the Arizona Antiquities Act is to protect the information contained in historic and prehistoric ruins, and paleontological deposits by controlling access to sites on State lands through a permit program administered by the ASM. The Act has been amended six times to keep pace with national and State historic preservation policy and is one of the strongest preservation and grave protection laws in the nation.

The University of Arizona has a consistent record of compliance with the State Historic Preservation Act and the Arizona Antiquities Act. New information about the cultural

resources on SRER is slowly but steadily gathered as archaeological surveys required by State law are conducted in advance of range management and range research projects.

Previous Archaeological Investigations

In the northeast corner of SRER lies Huerfano Butte. This rocky outcrop contains many archaeological features and will be described later on in this paper. In 1958 William Lindsay reported a bedrock seed-processing location on the Butte, and the ASM gave it a State site number. In 1965 the Butte gained public notoriety when a young girl discovered a prehistoric jewelry cache while on a picnic. This discovery resulted in the first and only scientific journal article about the archaeology of SRER (Bahti 1970).

In 1974 the U.S. Forest Service began to require surveys on the range in response to the passage of the National Historic Preservation Act. The Forest Service recorded eight small sites between 1974 and 1985.

Cynthia Buttery (1987) accomplished the first systematic archaeological inventory on the Range. Over a 2-year period from 1985 to 1986, Buttery recorded 46 Hohokam sites. This research was accomplished in partial fulfillment of her master's degree in anthropology at Texas Tech University and provided information for U.S. Forest Service and Research Station personnel to better manage and protect the cultural resources under their care.

From 1987 to present, five compliance surveys have been completed on the Santa Rita Experimental Range and were related to the placement of water pipelines, soil testing, and road improvement projects (Lange 1999; Lascaux 2000; Madsen 1991; Stone 2001; Swartz 2002). The most recent work by Swartz (2002) was in response to proposed carbon sequestration studies funded in part by NASA. The School of Natural Resources, University of Arizona contracted for archaeological assistance from Desert Archaeology, Inc., to meet Federal requirements for funding. Swartz examined the surface of six parcels prior to the excavation of trenches related to this study. The archaeological inspection resulted in the discovery, recordation, and avoidance of one small prehistoric site. Swartz also found historic features related to early research on the range. Swartz (2002: 17) found it interesting that: "Taken as a whole, across the entire 53,000-acre Range, ... markers and other remains from studies [conducted] in the first half of the twentieth century may meet eligibility requirements for inclusion in the National Register of Historic Places." These artifacts of past research on the Range may contribute to our understanding of the history of range research in the United States beyond the written record. By virtue of being an experimental station with 100 years of continuous operation and contributing significantly to range research, SRER today may warrant national recognition as an historic landmark.

Southern Arizona Prehistory

A short summary of southern Arizona prehistory is provided so that the reader can better understand the prehistoric cultural resources of the SRER. Some findings, particularly

those from Buttery (1987), are incorporated into the body of this summary, but most of the detailed information from her work on Hohokam resources will follow this summary.

Big Game Hunters

From archaeological and paleontological investigations a picture has emerged regarding life in the Western Hemisphere from 10,000 to 8,500 B.C. The term "Paleoindian" is used to identify the earliest inhabitants of North America. The origin and ethnicity of these people continues to be debated, but it is sufficient to say they moved about in small groups, lived in temporary camps, and hunted megafauna. Butchering sites with stone tools found in association with the remains of mammoth have characterized these people as big game hunters. In southern Arizona, known butchering sites are located in the San Pedro River Valley and Sulphur Spring Valley. A spear point type referred to as the Clovis Point (first discovered near Clovis, NM) has been found embedded in the bone of mammoth at the site of Naco, AZ (Haury 1953), and at the nearby sites of Lehner (Haury and others 1959), and Murray Springs (Hemmings 1970).

Mammoth remains have been found in the Santa Cruz River watershed. Within the boundaries of SRER a mammoth tusk was found in an eroding arroyo bank (Buttery 1987: 12). The discovery of Clovis points (Agenbroad 1967; Ayers 1970; Doelle 1985; Huckell 1982) and a later style of point called the Plainview Point (Agenbroad 1970; Hewitt and Stephen 1981; Huckell 1984a) indicate a presence of big game hunters in the Santa Cruz River Valley before 8500 B.C. However, archaeological sites with mammoth remains and Clovis or Plainview points have yet to be discovered in the Tucson Basin.

Archaic Hunter Gatherers

Mass extinction of mammoths, mastodons, camels, horses, giant ground sloths, and other large Pleistocene mammals is attributed to climatic change and excessive hunting. By 8500 B.C. the door closed on the big game hunter era, and for the next 7,000 years American Indians adapted to changing environments and landscapes. People focused on mixed subsistence strategies of hunting smaller game, fishing, and eating wild plant resources. Data on social organization, economy, and ritual behavior are severely limited, but there is evidence to show increased sedentism between the early and late periods. Across North America this period of 7,000 years has been separated into the Early, Middle, and Late Archaic periods. These periods are not chronologically similar from region to region. In Arizona, Archaic hunter-gatherer sites are assigned to one of three periods within the Southwest Archaic Tradition: the Early Archaic (ca. 7500 to 5000 B.C.), the Middle Archaic (ca. 5000 to 1700 B.C.), and Late Archaic (ca. 1700 B.C. to A.D. 150). The term Late Archaic is also synonymous with Huckell's Early Agricultural Period (Huckell and others 1995).

Transition to Agriculture

The term Early Agricultural best reflects the cultural setting between 1700 B.C. and A.D. 150. During this period

farmers irrigated fields of maize on the flood plain of the Santa Cruz River and farmed at the mouths of watered canyons. They supplemented their diet with deer and other small game and wild plant foods (Diehl 1997; Ezzo and Deaver 1998; Gregory 1999; Huckell and Huckell 1984; Huckell and others 1995; Mabry 1998; Roth 1989). Sedentism is expressed in the archaeological record by discoveries in recent years that include dozens of houses per village, irrigation ditches, and the byproducts of food processing such as carbonized or burned maize and animal bone. With people spending more time in one location, trash accumulated, as objects were discarded or cached away. The resulting material culture of the early agriculture period includes diverse flaked stone and ground stone tool assemblages, carved stone pipes, clay figurines, and crude pottery vessels. Seashell and other nonlocal resources indicate involvement in trade. Data on social organization and ritual behavior are speculative. Larger than normal oval structures found in village settings might be social or ritual places or perhaps the homes of influential people.

Huckell (1984b) excavated 10 sites at Rosemont on the eastern slopes of the Santa Rita Mountains immediately east of SRER; these sites span the later portion of the Southwest Archaic Tradition through the Early Agricultural Period. No such sites are recorded yet on SRER, but 10 diagnostic arrow points of Archaic and Early Agricultural origin have been found on the Range.

Early Ceramic Period

The Early Ceramic Period (A.D. 150 to 650) is a relatively new concept within the Tucson Basin (Heidke and Ferg 2001; Heidke and others 1998). Although ceramic artifacts, including clay figurines and crude plain pottery, were made during the Early Agricultural period, pottery containers revolutionized life after A.D. 150. Over this 500-year period, pottery was refined into nicely made plain ware and red ware vessels. A variety of new pit house styles are found—basically shallow rectangular pits protected by a framework of posts and beams supporting a coat of matted grass, brush, and mud. Overall a less homogenous culture is seen. As people become less mobile, more time is available to experiment and to adopt ideas from distant lands to make life easier. It is not known if these changes are a step in the evolution of the local sedentary population or reflect the influence of new people. Cultigens, including maize, beans, squash, and cotton, wild plants, and hunting were important parts of the subsistence economy. Greater quantities of imported materials such as turquoise, obsidian, and shell suggest a greater investment in a sedentary life. Data on social organization and ritual behavior remain speculative. The cultural setting by A.D. 650 sets the stage for the emerging Hohokam tradition.

Hohokam

Hohokam is the English pronunciation of Hu Hu Kam, a word used in the Piman language to mean "those who are gone." O'odham ancestral roots are deeply embedded in the ancient cultures of the Sonoran Desert.

The geographic extent of the Hohokam tradition coincides closely with the basic and persistent patterns of settlement

and subsistence seen in the Sonoran Desert before the sixth century A.D. By A.D. 650 new cultural traits such as pottery with red decoration, public architecture, and extensive irrigation systems are identifying characteristics of the Hohokam. These new cultural elements were so innovative that renowned archaeologists Harold Gladwin (1948) and Emil Haury (1976) postulated a Mesoamerican migration into the fertile Salt River and Gila River valleys. In recent years new archaeological data suggest that the traits that uniquely identify the Hohokam are products of internal experimentation as well as the external influences of the Anasazi and Mogollon cultures and the northern cultures of Mesoamerica.

Hohokam Community—For purposes of this discussion, Hohokam history is divided into the Preclassic period (A.D. 650 to 1150) and the Classic period (A.D. 1150 to 1450). The Hohokam aggregated into cohesive agricultural communities that occupied every hospitable niche within the Sonoran Desert. The term “community” refers to clusters of sites dominated by villages of different size and social complexity that maintained farmsteads, multifaceted agricultural systems, and smaller sites located strategically to acquire natural resources (Fish and others 1992).

Each community had a central village supporting one or more forms of public architecture. In the Preclassic period, clay-capped ceremonial mounds and ball courts identified the religious, economic, and social centers of a community (Gladwin and others 1937; Wilcox and others 1981; Wilcox and Sternberg 1983). A shift in Hohokam ideology eventually caused the decline and eventual abandonment of ball court centers and the rise of Classic-period platform mound communities reflecting the emergence of new positions of authority. O’odham oral history suggests that platform mounds may have been built for the Hohokam elite (Teague 1993).

Hohokam community organization speaks to a high order of cooperation and social interaction that reaches beyond community boundaries. These same organizational skills are also seen at the village level with remarkable consistency through time. During the Preclassic period, families organized into cohesive courtyard groups. Each courtyard group contained clusters of rectangular pit houses, cooking ovens, cemeteries, and trash disposal areas positioned around the edge of a common open space (or courtyard). In some larger villages, multiple courtyard groups were positioned around larger central plazas (Doyel 1991).

By the Classic period the courtyard group takes on a pueblo design because of innovations in architectural materials, particularly adobe block construction. Villages contain from one to as many as 20 compounds, each defining the living and working space of a related social group. Within compound walls, groupings of houses and ramadas face common yards containing workspace and cemeteries. Trash mounds and large cooking ovens lie on the exteriors of compound walls.

Hohokam Farming—By the sixth century A.D., the people of the Sonoran Desert had had nearly 2,000 years to hone their agricultural strategies. In the broadest river valleys like the Phoenix Basin, Preclassic and Classic-period Hohokam communities were organized to maintain one or more river-fed irrigation systems. Villages and farms were

strategically positioned along miles of arterial aqueducts, canals, and ditches that provided water to croplands.

In narrow river basins like the Santa Cruz and San Pedro, mountains squeeze the flood plains into narrow stripes of fertile land. During the Preclassic and Classic period, Hohokam communities organized along the edges of these flood plains and successfully used river water to irrigate crops. The narrowness of valleys also offered the same communities an opportunity to diversify their agricultural strategies by farming the alluvial fans of nearby mountains. Here the Hohokam planted the lower limits of fans where a combination of direct rainfall and the construction of diversion dams directed water from swollen washes to adjacent fields.

In basins with no perennial waters alluvial-fan farming was supplemented with other farming techniques including diverting rainwater into deeply excavated storage reservoirs for domestic use and pot irrigation, blocking gullies with rock terraces to capture flowing water and sediments, and planting crops in gardens bordered on all sides by rock walls that captured rainwater, prevented runoff, and caused soil saturation. Specialized crops like agave were grown in piles of soil and rock that caused a mulching effect and minimized evaporation.

Hohokam Craft Specialization—Part of the diverse material culture of the Hohokam—craft specialization—emerges from the early ceramic period and takes on a strong Mesoamerican orientation. Seashell, minerals and rock, animal bone, plant fiber, and clay were transformed into utilitarian, status, and ritual objects with diverse form and function. The common person possessed the skill to make plain ware pottery and flaked stone tools for hunting, harvesting, and processing food, but skilled craft specialists were spread throughout communities and were actively involved in repetitive manufacture of products and their subsequent trade. People specialized in making jewelry, ritual objects of stone and clay, textiles, and decorative pottery.

Pottery such as bowls, jars, ladles, and effigy forms, with painted red designs was the signature of the Hohokam people. The earliest decorated pottery was a gray ware with simple incised exterior lines and red painted designs. By A.D. 800 brown pottery with red designs dominated southeastern Arizona while buff-colored pottery with red designs dominated the central basins of the Salt and Gila Rivers. By A.D. 1300 the introduction of distinctive red, black, and white polychrome pottery provides intriguing questions about cultural influences, suggesting, perhaps, the acceptance of outside ideology and/or religion (Crown 1994).

The momentum of the Hohokam culture wanes by A.D. 1350, and their descendants reorganize themselves over the landscape. Pima oral histories tell of social and political upheaval and of environmental factors that profoundly alter the cultural landscape of the Sonoran Desert (Teague 1993).

Reorganization Period

By A.D. 1450 warfare, drought, floods, disease, or some combination of these factors caused change in the structure of Hohokam society. Desert people did not vanish from the landscape—they simply reorganized. In 1697, Captain Juan

Mateo Manje and Father Eusebio Kino explored the valleys of the San Pedro, Gila, and Santa Cruz Rivers. In the Gila River Valley these explorers noted the abandoned Casa Grande Ruin and other burned out Hohokam towns. Yet the Spanish encountered fertile irrigated croplands and many villages, where often hundreds of people would come out to welcome them. People were still living a sedentary lifestyle, but it was seemingly on a different scale than 250 years prior and analogous to that of people living a thousand years earlier. Villages were nothing more than clusters of small oval huts built of sticks and mats (Burrus 1971; Karns 1954). The people encountered by Kino were the descendants of the Hohokam and are the ancestors of the O'odham-Piman people.

Southern Arizona History

Hispanic Arizona—Hispanic Arizona is separated into the Spanish Colonial period (1536 to 1821) and the era of Mexican Independence (1821 to 1856). Most of the major river valleys of present-day Arizona were explored, and a pattern of European settlement was established over this 320-year span. Life on the northern frontier of New Spain was dangerous, and for the Spanish, and for the later Mexican citizen, being able to safely and permanently settle in any one location was never easy.

Franciscan priests attempted a permanent secular presence with the Hopi Tribe from 1629 to 1730 but met with little success. In southern Arizona the Jesuits similarly placed priests at the Indian settlements of Guevavi and Bac on the upper Santa Cruz River between 1701 and 1732. It was not until 1736, when silver was discovered south of present-day Nogales, that miners and ranchers hurried to the borderland of New Spain. The stage was now set for a permanent Hispanic presence in what is now Arizona, and the Santa Cruz River drainage attracted the highest density of Hispanic people. Thereafter, conflict with Indian communities, particularly the conflict between the Apache and Spanish colonists, impeded permanent political and social stability. Even the stationing of garrisoned troops and the building of four presidios, including one at Tubac (established 1751) and one at Tucson (established 1776), did little to protect missionaries, miners, ranchers, and Indian allies. A brief negotiated peace between the Apache Indians and the Spaniards brought calm to the region around 1790, but the success of the Mexican Independence Movement culminated in the end of Spanish rule in 1821, bringing new political problems and instability between the Hispanic population and American Indian.

During the Mexican period (1821 to 1854), conflict with the Apache people intensified in the borderlands, and settlers again retreated to the safety of the presidio forts. Only the courageous dared to face the isolation of the mining camps and ranches of the hinterlands. The instability of the period is exemplified by the failure of land grants. The San Ignacio De La Canoa Land Grant is of particular interest because of its proximity to SRER. In 1821 brothers Tomás and Ignacio Ortiz gained title to 42,000 ha (17,000 acres) along the Santa Cruz River, extending from the western edge of SRER south to present-day Amado. The southern boundary of the land grant was just a few miles north of the presidio of Tubac, yet by 1835 repeated Apache raids forced

the brothers to abandon their ranch and to tend their herds from the safety of the Tubac Presidio.

United States Annexation—Mexico's refusal to sell lands to the United States or to resolve land disputes in Texas resulted in the Mexican War of 1846. The Treaty of Guadalupe Hidalgo in 1847 ended Mexican control over a vast region, including Texas, as well as portions of New Mexico, northern Sonora, and upper California. Under the Compromise of 1850, the U.S. Congress created the New Mexico Territory, including present-day Arizona north of the Gila River, Southwest Colorado, southern Utah, and Southern Nevada. The Treaty of La Mesilla, also known as the Gadsden Purchase, finally clarified international boundaries in 1854 when the United States purchased 30,000 square miles south of the Gila River.

The period of annexation was a time of transition in the Santa Cruz River Valley. To paraphrase Sheridan (1995), most Anglo Americans viewed southern Arizona as an obstacle and a wasteland on their way to better lands. In 1846 the Mormon Battalion passed through Tucson while mapping a route to California. On their heels came scores of miners, merchants, and stockmen lured west by the discovery of gold in California in 1848. Through the 1850s and 1860s, Anglo attempts at ranching and mining in the Santa Cruz River Basin were marginal and paid few dividends. The Civil War created new problems as Union forces left the region, opening it to Apache reprisals. For example, between 1855 and 1862 cattle ranching continued on the San Ignacio De La Canoa Land Grant; by 1859 a lumber mill, hotel, and tavern were built just southwest of SRER at La Canoa. Apache raiders burned the newly constructed buildings in 1861 (Willey 1979). In 1862 the Civil War reached Tucson when a brief tug-of-war over occupation ended with Union Troops in possession and Confederate Troops retreating to Texas.

The U.S. military, like their Spanish and Mexican predecessors, could do little to calm old and new ethnic conflicts throughout the period of annexation. During this period, however, Mexican and Mexican-American residents established the foundation of later successes in southern Arizona.

Arizona Territory (1863 to 1912)—In 1863 the Arizona Territory was carved out of the Territory of New Mexico. The land once considered an obstacle to westward expansion was rediscovered. From 1863 forward, Arizona's gold, silver, and copper resources lured an aggressive rush of miners to the territory, and with each new discovery mercantile centers thrived. The cattle boom of the 1880s paralleled the growth of mining; and, finally, the arrival of the railroad through southern and northern Arizona culminated in the end of the frontier. Throughout the entire era, a growing U.S. military presence broadened warfare, leading to suppression and confinement of Arizona's Indian tribes.

Santa Cruz River Valley—In the 1860s and 1870s, Tucson thrived as a center of commerce and was the territorial capital from 1867 to 1877. Mexican and Mexican-American businessmen dominated the economic markets and provided the majority of services to settlers, ranches, mines, farms, and above all military posts. Networks of freight wagons delivered produce from Mexico, as well as hardware and other goods from the east and west coasts. By 1881 the

Southern Pacific Rail Road offset the balance of power in Hispanic Arizona. Easterners rolled into the region and successfully outbid the established frontier merchants for local markets.

South of present-day Tucson, SRER was in the shadow of the ranching and mining booms. Frederick Maish and Thomas Driscoll ran cattle on the San Ignacio De La Canoa Land Grant in the late 1860s and purchased the land from founder Tomás Ortiz in 1879. By 1899 they had acquired title to the Grant from the U.S. Government. Copper was discovered at the north end of SRER in 1875. Here the mining town of Helvetia had ups and downs with some mining successes until it was abandoned in 1911. The Narragansett Copper Mine was established on the eastern edge of SRER in 1879. Thereafter, a community of 150 people worked the Rosemont Copper Mill and Smelter from 1894 to 1910.

Buttery (1987) notes the presence of at least three historic-period ruins on SRER, and Swartz (2001) notes evidence of past range experimental plots that may date to the Territorial and Statehood periods. Little information exists to fully describe these historic resources. Nathan Sayre (this proceeding) provides an overview of the history of the SRER, and his data will provide a glimpse of what historic resources may lie untapped and awaiting anthropological/archaeological study.

At this point I return to a more indepth look at the Hohokam culture and the patterns of Hohokam use of land within the Santa Rita Experimental Range.

Cultural Resources on the Range

The work by Buttery (1987) provides the primary source of information about Range cultural resources. The principal reason for Buttery's research was to examine how specific environmental factors such as landform, soil, hydrology, and to a broader extent vegetation, influenced how people organized themselves over the landscape in the prehistoric past.

Buttery conducted a systematic surface inspection of the Range with a crew of two to three people spaced 20 m apart. This team walked north-south transects along U.S. Geological Survey (USGS) topographic section lines and half-section lines. These parallel transects at half-mile intervals were chosen to give an evenly spaced, systematic sample covering of all biotic zones on the Range. Based on transect width and length, Buttery indicates that approximately 19,700 ha (8,000 acres), or a 15-percent sample of the 146,000-ha (53,000-acre) range was inspected for archaeological resources. Buttery found 46 prehistoric sites during her study (fig. 1). Sites were plotted on USGS 7.5-minute topographic maps and on to Mylar™ sheets covering 1:24,000-scale aerial photographs. The surface characteristics of each site were recorded on U.S. Forest Service site forms, and sketch maps were made. All site forms are on file at the Supervisor's Office of the Coronado National Forest in Tucson, AZ. Site information is now available to qualified researchers through the State AZSITE Geographic Information System.

Criteria for designating sites were based on the standards of the Coronado National Forest in 1985. Archaeological

sites were defined by the U.S. Forest Service as the presence of six or more artifacts in proximity to each other on the surface, or by the presence of obvious prehistoric features on the landscape, such as seed-processing sites with mortar holes in bedrock outcrops.

In 1985 considerable data were available from adjacent regions to seriate Hohokam sites by time periods, and to classify sites into functional groups based on surface artifact assemblages and visible surface features. Borrowing from a site classification system used during Phase B of the Central Arizona Project (Czaplicki and Mayberry 1983: 27–29), Buttery sorted SRER sites into five categories: (1) Lithic Scatters, (2) Garden Sites, (3) Limited Activity Sites, (4) Habitation Sites, and (5) Specialized Activity Sites.

Lithic Scatters (Places Where Stone Tools Were Made)

The Hohokam and their predecessors were expedient toolmakers. If a task required the use of cutting, scraping, or piercing tools, the nearest source of fine-grained rock was used to make the needed implement. The import of exotic stone tools and raw material from outside southern Arizona occurred but was not in any way necessary or extensive.

The Santa Rita Mountains provide a wide range of rock types suitable for making stone tools. On the Range, fine-grained black to gray porphyritic andesite is found in abundant quantities on cobble terraces overlooking the Santa Cruz Floodplain (Jones and others 1998). The same material is plentiful in streambeds on the upper bajada.

Buttery identified six lithic scatters where someone split porphyritic andesite cobbles to make tools. Lithic scatters are characterized by the presence of cores, flakes, and waste debris. Stone cores are cobbles with flakes removed; the resulting flakes are sharp and can be used for cutting, or can be flaked further into other tools. Debris is the byproduct of toolmaking. Three lithic scatters were found in the upper reaches of Sawmill Canyon, and three others at the lower reaches of this drainage. These sites range from 80 to 270 m² in size.

Garden Sites

Prehistoric agricultural fields marked by rock piles and low stone alignments cover hundreds of hectares along the edge of the flood plain of the Santa Cruz River from the international border to locations 80 miles downstream at Marana (Fish and others 1992). Interdisciplinary study of these prehistoric agricultural complexes has detailed the nature and extent of agave cultivation during the later portion of the Hohokam sequence. Rock piles and stone terraces enhance the planting environment of the agave plant. The uneven, porous surface of a rock pile allows penetration of rainfall, and the rock acts as mulch, slowing evaporation of soil moisture. Agave pups gathered from a high-elevation habitat in the Santa Rita Mountains were transplanted into rock piles at lower elevation. Agave (or century plant) has been a source of food and fiber for most aboriginal groups of North America living within the distributional range of these drought-adapted perennial succulents.

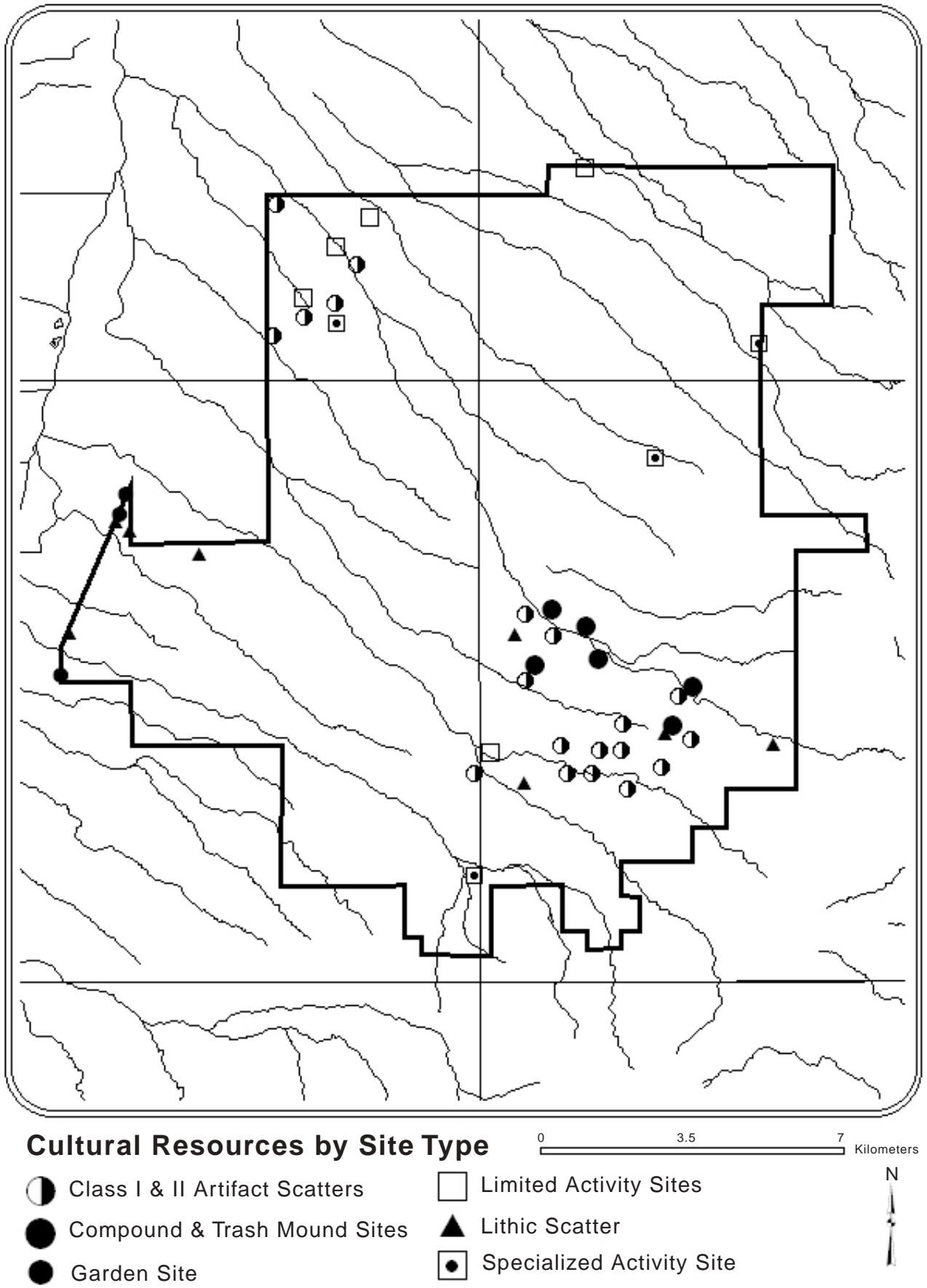

Figure 1—Archaeological site locations on the Santa Rita Experimental Range.

Four agave fields were recorded on the lower bajada of SRER below 945 m (3,100 ft) elevation. Fields range from 391 to 10,000 m² in size with four to 18 rock piles per site. One agricultural site has a 60-m-long rock terrace. Buttery found no habitation sites near these fields and postulated that people living on or near the flood plain maintained them. Recent work on the western periphery of SRER (Jones and others 1998) shows that villages dating to the late pre-Classic and early Classic periods are within a mile of Buttery's agave fields.

Limited Activity Sites

Seven Hohokam sites, each with fewer than 25 artifacts, were scattered between the upper and lower bajada. These sites range from 12 m² to 6,360 m² in size and contain plain ware pottery and flaked stone artifacts. One of the sites has three unidentified decorated pot sherds. From this limited information no particular function can be assigned to these sites.

Habitation Sites

Over half of the sites recorded by Buttery on SRER (25 of the 46 sites) are identified as habitation sites. As the word implies, these are places where people built houses and lived seasonally or year round. To determine seasonal versus year-round habitation requires a multidisciplinary approach to many lines of excavated archaeological data, but habitation in the broadest sense is easily recognized without excavation from specific indices of artifacts and features seen on the surface. Buttery separated habitation sites into four categories based on the types of artifacts and feature exposed on the surface.

Compound Sites—By A.D. 1150 the Hohokam were building their houses within walled compounds. Compounds were made from solid adobe blocks or from upright posts intertwined with sticks and brush and bound together with adobe mud. Evidence of both construction methods are expressed archaeologically by remnant stone footings on the surface.

Two habitation sites on the upper bajada of SRER are classified as compound sites. One site has two small rock compounds with interior spaces of 48 m² and 108 m². Thirteen other segments of wall footing were also recorded including one footing 25 m long. The larger compound site has a rock footing nearly 40 m long with three attached perpendicular walls about 10 m long each. Two rectangular rooms are attached to the interior of this enclosure.

Besides hundreds of broken pieces of plain utilitarian pottery and a few decorated pieces, the artifacts on the surface of both sites include food-grinding tools and flaked-stone cutting, scraping, and piercing tools. The dates of occupation are tentatively placed after A.D. 1150 based on the Classic period compound architecture. A few pieces of Rincon Red-on-brown pottery, dated to between A.D. 950 and 1150, were found on both sites. Another pottery type called Tanque Verde Red-on-brown dated between A.D. 1150 and 1300 was found on one of the sites. Site area is based on the distribution of artifacts on the surface. The first site covers an area of 14,000 m², and the second, larger site

covers an area of 105,340 m². The potential for buried cultural features on both sites is certain.

Trash Mound Sites—Villages occupied year round or seasonally over many years have locations set aside for trash disposal. After repeated dumping episodes in one location, trash accumulates into mounds, and if conditions are favorable, these mounds remain visible for centuries. On the upper bajada of SRER four villages were occupied for extended periods of times as suggested by the presence of trash mounds. Two villages have four trash mounds, and the two others each have one mound. Most of the mounds are only a few centimeters high and are identified by the presence of artifact concentrations, but the largest known trash mound on SRER covers 72 m² and is mounded 50 cm high.

Based on the distribution of surface artifacts, the four villages range from 70,000 to 200,000 m² in size. Artifacts scattered across these sites include plain utilitarian pottery, flaked-stone cutting, scraping, and piercing tools, and waste flakes and debris from toolmaking. Seed-grinding tools (manos and metates) and jewelry made from seashells are present. Three of the four villages have datable decorated pottery including Rincon Red, and Rincon Red-on-brown, as well as Sacaton Red-on-buff, indicating occupation between A.D. 900 and 1150. The earliest of the four sites has one trash mound with Santa Cruz Red-on-buff pottery placing its occupation between A.D. 875 and 950. With little doubt, these sites have archaeological deposits that include many buried houses and features.

Class I Artifact Scatters—Buttery used the term "Class I Artifact Scatter" to describe sites with three or more types of artifacts. These sites have no surface evidence of trash mounds, but a few have heavy concentrations of artifacts that may represent locations of trash disposal. The absence of trash mounds may have to do with the length of occupation, the intensity and type of use, or the rate of deflation. It is certain that some of these sites represent permanent villages with several houses, while others in this group may be small seasonal farmsteads with a few houses or ramadas. The surface areas of these sites range from 8,000 m² to as large as 306,000 m².

Plain utilitarian pottery, flaked-stone cutting, scraping, and piercing tools, waste flakes, and debris from toolmaking are present on most of these sites. Twelve sites have food-grinding implements (manos and metates). Dispersed unevenly among the 14 sites are seashell artifacts, carved stone jewelry, tabular agave knives, a stone axe, pottery spindle whorls, a quartz crystal, evidence of a cemetery, and rock pile clusters protruding through the surface.

Five of the 14 sites have datable decorated pottery. Rincon Red-on-brown dating from A.D. 900 to 1150 is dominant, followed by Rillito Red-on-brown (A.D. 875 to 950), and unidentified buff ware sherds.

Class II Artifact Scatters—Buttery grouped these four sites together because the artifact assemblages are limited to broken pottery and flaked stone. Plain ware (utilitarian brown ware) is the dominant pottery type on the surface of these sites. Rincon Red-on-brown on three sites suggests an occupation between A.D. 900 and 1150. Flaked stone is limited to flakes and cores (cobbles with flakes removed), hammer stones (tools for removing flakes from cobbles), and

cutting tools. One site has a single small rock pile of indeterminate function. These sites range from 14,000 to 95,000 m² in size, and although they are large sites, the surface artifact assemblages lack the variety usually found at permanent habitation sites. The proximity of Class II sites to washes and fans may indicate they were seasonal habitation sites that functioned as farmsteads.

Special Activity Sites

These four sites are diverse in function. The first is a plant-processing site where four mortar holes and four grinding slicks (bedrock metates) were created on exposed bedrock near the mountain pediment. In these locations, food products like mesquite pods were milled or ground into flour with stone pestles and manos. Buttery notes that the largest mortar hole is 15 cm in diameter and 9 cm deep. The four nearby bedrock grinding slicks each measure about 70 cm long, 30 cm wide, and 18 cm deep.

The second special activity site is located at Huerfano Butte, a small rocky hill in the northeast quadrant of the Range. Buttery notes that shallow bedrock forces ground water to the surface in a wash on the south side of the Butte. Exposed outcrops of granite on either side of the wash have 50 bedrock mortar holes and numerous smaller cupules, further suggesting that the location may have been a reliable water source at times. Along the same wash is a vertical stone surface with pictographs painted in red hematite. The paintings include human and animal life forms as well as concentric circles. A few plain ware and unidentified decorated pottery sherds and flaked-stone artifacts were noted in the area. As mentioned earlier, Huerfano Butte gained notoriety in 1965 when a young girl discovered an extensive prehistoric jewelry cache while on a picnic. While exploring cracks and crevices on the butte the young girl discovered a prehistoric bowl filled with turquoise and shell beads, as well as carved bird and frog pendants. This discovery resulted in the first and only scientific journal article about the archaeology of SRER (Bahti 1970). The cached offerings, the red paintings, and the numerous food-processing features may or may not be related, but one can imagine that a reliable water source near, or on the surface, is an element that could bind all of the site's features together.

The third special activity site is associated with food processing. It is located on the lower bajada in an area experiencing deflation. The site is 98,400 m² in size, and within its boundaries are 34 rock piles, most of which are check dams. Some of the other rock features are hearths and roasting pits filled with broken and fire-charred grinding implements. Buttery recorded 70 manos, 5 metates, and observed several pestles. The pottery at this site is dominated by mostly broken plain ware, but four broken decorated sherds were noted, including Snaketown Red-on-buff (A.D. 650 to 900), Rincon Red-on-brown (A.D. 900 to 1150), and Tanque Verde Red-on-brown (A.D. 1150 and 1300). Buttery noted a dozen modified sherds, some ground round into spindle whorls. Buttery noted that the flaked-stone tools made from black porphyritic rhyolite were abundant and include flakes, scraping and cutting tools, and cores.

The fourth special activity site is located in Florida Canyon and was identified as a source of black porphyritic

cobbles. These cobbles were broken to test the quality of the stone for toolmaking. Some material was used on the spot to make tools, but it is also likely that cobbles were collected and taken elsewhere for use (see "Lithic Scatter" above). This site covers 70,000 m² of land. The discovery of an Archaic triangular biface tool along with plain ware Hohokam pottery suggest a long history of use. Every habitation site on SRER contains stone artifacts made from black porphyritic igneous rock, and as indicated earlier, Florida Canyon is not the only source for this material. Other drainages certainly have similar deposits of stone as do the lower bajada Holocene fans and ridges (Jones and others 1998).

Settlement Pattern

The pattern of Hohokam settlement on the northern slopes of the Santa Rita Mountains reflects both environmental risks and opportunities. Settlement will be examined in its relationship to the availability of resources on the upper bajada, middle bajada, and lower bajada of the Range.

Upper Bajada—Finding large numbers of Hohokam sites in upper bajada locations is a common pattern in the basin-range country of the Sonoran Desert, particularly where mountains rise above 1,219 m (4,000 ft) in elevation. The Santa Rita Mountains rise just over 2,881 m in elevation (9,453 ft), and the bajada slopes around the entire base provide many opportunities conducive to human settlement. Buttery indicates that 63 percent of the Hohokam sites on the Range are located on the upper bajada between 1,097 m (3,600 ft) and 1,341 m (4,400 ft) above sea level. Here, there is enhanced precipitation from orographic rainfall, sufficient elevation to lessen frost from cold air drainage, surface water, and bedrock water catchments. The bajada itself offers plant foods like mesquite pods and cacti fruit, and proximity to the mountain provides access to a rapid succession of plants and animals used for a variety of purposes, including food, clothing, and shelter.

The Hohokam living on the northern side of the Santa Rita Mountains depended on the relatively abundant local precipitation for domestic and agricultural use. The uplift of moisture-laden air passing over the Santa Rita Mountains delivers predictable precipitation to the mountain peaks, provides perennial surface water in canyons, and heightened chances for direct rainfall on the upper bajada in the winter and summer months, probably more so than on the valley floor. At the mountain front, Holocene sediments over bedrock are typically no deeper than a few meters; accessible water tables at the mouth of Box Canyon and Sawmill Canyon and in nearby ephemeral drainages were important factors in settlement location.

Upper bajada agriculture—Bottomlands with high agricultural potential are not evenly distributed along Box and Sawmill Canyons but vary with factors such as width and morphology of the flood plain, water-table depth, watershed size, and drainage gradient. The importance of such acreage for supporting relatively dense populations is indicated by the locations of large habitation sites along those stretches of Box Canyon and Sawmill Canyon suitable for flood plain fields. Buttery suggests that the water may have flowed in these canyons continuously in the prehistoric period.

The Holocene soils on the broad upper bajada terraces between major washes are also suitable for agriculture.

The surface runoff would have easily infiltrated the sandy Holocene soils and remained close to the surface because of the underlying Pleistocene clay soil. When the water reaches the clay soil, it would begin to move laterally. At the point where the sandy soil becomes shallow or pinched out, it is likely that there would have been free water on or near the surface, thus creating temporary seeps following above average winter precipitation.... (Buttery 1987: 92).

Between 1,097 m (3,600 ft) and the mountain pediment, Buttery noted locations where moist conditions near the surface caused lush growing condition for local gasses.

Middle Bajada—The middle reach of the Range's bajada was not a place of settlement because drinking water was inconveniently distant at either the Santa Cruz River below or at the mountain edge above. As Box Canyon and Sawmill Canyon drain downhill and cross into the mid-bajada, surface flow tends to diminish or disappear in channels through infiltration into increasingly deep valley fill. The lower limit of habitation sites on Box Canyon and Sawmill Canyon probably mark the downslope extent of significant surface flow from all but the largest precipitation events following major storms.

Many small drainages with bajada catchments are sufficiently shallow that farmers from upper and lower bajada settlements could have successfully farmed the middle bajada by diverting storm water into fields. However, water would have been available only in cases of storms directly over the watershed, a relatively unpredictable event compared to higher elevation precipitation triggered by uplift of air over the mountains. At this time there is no archaeological evidence suggesting agricultural use of this zone.

The vegetation regimes seen on the Range today probably mimic to some extent the Range around A.D. 1150, when the prehistoric population was at its highest. If there were any differences, it is in the frequency of native trees and plants seen today as opposed to the presence or absence of these species in the past. Within the Tucson Basin, analysis of charcoal from 21 roasting pits dating from A.D. 1150 to 1300 (Fish and others 1992) and from a single roasting pit dating from A.D. 894 and 1148 (Van Buren and others 1992) shows abundant fuel woods of mesquite, ironwood, and palo verde, all consistent with the vegetation seen in the same locations today. It is likely that exploitation of annual and perennial plants in the middle bajada was frequent and shared by the people living above and below this zone.

Lower Bajada—Buttery indicated that 37 percent of the sites on the Range are below 945 m (3,100 ft) and include small agave gardens, lithic scatters, a plant-processing site, and five habitation sites. Lower bajada habitation sites are linked to the flood-plain community. Here water in the Santa Cruz River, and at springs like those at Canoa, provides domestic water sources. Like elsewhere, mesquite, cactus, and other annual and perennial plants provided food resources. Hardy upland agave plants also were transplanted to lower elevation gardens, cultivated, and successfully propagated for food and fiber on the gravel ridges overlooking the flood plain.

Low bajada agriculture—Alluvial fans, composed of outwash sediments from the uplands, coalesce on the lower

bajada north of Box Canyon. Gentle slopes provide an active depositional environment and controllable water flow. In these situations flood waters following storms provided both moisture and simultaneous enrichment for crops in the form of suspended nutrients and organic detritus. The clustering of habitation sites at the lower limits of alluvial fans on the Range mirrors similar patterns throughout the Santa Cruz watershed.

Hohokam Community

The archaeological survey conducted by Buttery covered approximately 19,700 ha (8,000 acres), or a 15-percent sample of the 146,000 ha (53,159 acres). Of the 46 archaeological sites recorded, 25 are habitation sites representing places of permanent or seasonal habitation by the Hohokam people. This sample of area and sites provides sufficient information to predict with some confidence that many more Hohokam sites are present on the Range. The majority of the recorded Hohokam habitation sites were occupied between A.D. 900 and 1150, and at least two were occupied until A.D. 1300. As indicated in the cultural history section of this paper, the Hohokam organized into communities with central sites with public architecture at their core. There is little doubt that the dense Preclassic population on the Range is part of one or more communities. This suggests that a central site with a ball court, a form of Hohokam public architecture associated with Preclassic communities, should be found somewhere on the Range probably in an upper bajada location. There is insufficient information on Hohokam Classic period sites, with only two recorded at this time, to understand their place and relationship to other sites.

Concluding Comments

Cultural Resource Management on the Range

Preservation of archaeological resources for scientific investigation outside the Range is not possible except in rare instances. Since 1987, over 29,600 ha (12,000 acres) of land has been inspected for archaeological sites on the western and northern periphery of the Range, mostly as the result of enforcement of the Pima County Cultural Resource Ordinance (Sec. 18.81.060,B.10). These inspections resulted in the recordation of over 400 archaeological sites, but unfortunately only a small portion of these sites will be set aside for preservation in perpetuity. Those sites not fully protected will be subjected to compliance-related archaeological investigations. Unfortunately, the cost of scientific study is very expensive, and all work is more often than not geared to collecting samples that never capture the full breadth and understanding of how people lived and survived in these arid lands.

This is why cultural resources inside areas like the Santa Rita Experimental Range are so important to protect. Within the Range lies important information about the prehistory of the region and the history of homesteading and ranching. Equally important is archaeological information about the history of range experimentation itself, and how early scientific research was carried out. A record of this scientific use

is embedded in the landscape and will not be found in the written or photographic history of the Range. Beyond the humanistic elements of archaeology, sites on the range contain vast amounts of information useful to studies of climate, plant and animal ecology, geology, and geomorphology.

We are rapidly approaching the time when the Santa Rita Experimental Range finally and forever will be enclosed on three sides by a dense urban landscape. High-density residential communities will create new challenges for the Range and will require an increased commitment on the part of the Arizona State Land Department, the Arizona Game and Fish Department, the Arizona Department of Agriculture, and the University of Arizona to manage and monitor the health of the Range.

A complete inventory of SRER cultural resources will facilitate the implementation of future range projects, to include improvements to the land needed in the normal course of use and during the selection of lands for scientific study related to the principal purposes of the experimental range. With the inevitable growth around the periphery of the Range, inventories of cultural resources are necessary for the sheer purpose of protecting them and for assessing impact from allowable public use within the current context of State law and State Trust lands policy.

Cultural resource inventory can coincide with the teaching mission of the University of Arizona. Opportunities for students to design and implement research on the scale of the work accomplished by Buttery (1987) and Fish and others (1992) abound on the Range, and can co-occur and even complement and contribute important information useful to the research objectives of the modern day range ecologist. With that said, the 100th Anniversary of the Santa Rita Experimental Range also presents an opportunity for constituents with common interests in the survival of the Range to develop a long range plan that binds public and scientific interest in this open space.

References

- Agenbroad, Larry D. 1967. The distribution of fluted points in Arizona. *The Kiva*. 32(4): 113–120.
- Agenbroad, Larry D. 1970. Cultural implications from the statistical analysis of a prehistoric lithic site in Arizona. Tucson: University of Arizona, Department of Anthropology. Thesis.
- Ayres, James E. 1970. Two Clovis fluted points from Southern Arizona. *The Kiva*. 35(3): 121–124.
- Bahti, Mark. 1970. A cache at Huerfano Butte. *The Kiva*. 36(2): 17–22.
- Burrus, Ernest H. S. J. 1971. *Kino and Manje: explorers of Sonora and Arizona. Sources and Studies for the History of the Americas* 10. Rome and St. Louis: Jesuit Historical Institute.
- Buttery, Cynthia E. 1987. Investigations into prehistoric settlement and subsistence on the Santa Rita Experimental Range, southern Arizona. College Station: Texas Tech University. Thesis.
- Crown, Patricia L. 1994. *Ceramics and ideology: Salado Polychrome pottery*. Albuquerque: University of New Mexico Press.
- Czaplicki, Jon S.; Mayberry, James D. 1983. An archaeological assessment of the middle Santa Cruz River Basin, Rillito to Green Valley, Arizona, for the proposed Tucson Aqueduct Phase B, Central Arizona Project. Arizona State Museum Archaeology Series 164. Tucson: University of Arizona, Arizona State Museum.
- Diehl, Michael W. 1997. Archaeological investigations of the Early Agricultural Period Settlement at the Base of A-Mountain, Tucson, Arizona. Tech. Rep. 96-21. Tucson, AZ: Center for Desert Archaeology.
- Doelle, William H. 1985. Excavations at the Valencia Site-A Preclassic Hohokam Village in the Southern Tucson Basin. Institute for American Research, Anthropological Papers 3. Tucson, AZ: Institute for American Research.
- Doyel, David E. 1991. Hohokam cultural evolution in the Phoenix Basin. In: Gumerman, George J., ed. *Exploring the Hohokam, prehistoric desert peoples of the American Southwest*. An Amerind Foundation Publication, Dragoon, Arizona. Albuquerque: University of New Mexico Press.
- Ezzo, Joseph A.; Deaver, William L. 1998. *Watering the desert: late archaic farming at the Costello-King Site*. Tech. Series 68. Tucson, AZ: Statistical Research.
- Fish, Suzanne K.; Fish, Paul R.; Madsen, John H., eds. 1992. *The Marana Community in the Hohokam World*. Anthropological Papers 56. Tucson: University of Arizona Press.
- Gladwin, Harold S. 1948. Excavation at Snaketown. IV. Review and conclusions. *Medallion Papers* 38. Gila Pueblo, AZ: Globe.
- Gladwin, Harold S.; Haury, E. W.; Sayles, E. B.; Gladwin, Nora. 1937. Excavation at Snaketown, Material Culture, *Medallion Papers* 25. Gila Pueblo, AZ.
- Gregory, David A., ed. 1999. Excavation in the Santa Cruz River Floodplain: the Middle Archaic Component at Los Pozos. Anthropological Papers No. 21. Tucson, AZ: Center for Desert Archaeology.
- Haury, Emil W. 1953. Artifacts with mammoth remains, Naco, Arizona 1. Discovery of the Naco mammoth and associated projectile points. *American Antiquity*. 19: 1–14.
- Haury, Emil W. 1976. *The Hohokam: desert farmers and craftsmen*. Tucson: University of Arizona Press.
- Haury, Emil W.; Sayles, E. B.; Wasley, William W. 1959. The Lehner mammoth site in southeastern Arizona. *American Antiquity*. 25(1): 2–30.
- Heidke, James M.; Ferg, Alan. 2001. Ceramic containers and other artifacts of clay. In: Gregory, D. A., ed. *Excavation in the Santa Cruz River Floodplain: the Early Agricultural Period Component at Los Pozos*. Anthropological Papers No. 21. Tucson, AZ: Center for Desert Archaeology: 163–194.
- Heidke, James M.; Miksa, Elizabeth J.; Wiley, Michael K. 1998. Ceramic artifacts. In: Mabry, J. B., ed. *Archaeological Investigations of Early Villages in the Middle Santa Cruz Valley; analysis and Synthesis*. Anthropology Papers No. 19. Tucson, AZ: Center for Desert Archaeology: 471–544.
- Hemmings, Thomas E. 1970. *Early man in the San Pedro Valley, Arizona*. Tucson: University of Arizona, Department of Anthropology. Dissertation.
- Hewitt, James E.; Stephen, V. M. David. 1981. Archaeological investigation in the Tortolita Mountain Region, Southern Arizona. Pima Community College Anthropology Series, Archaeological Field Report No. 10. Tucson, AZ.
- Huckell, Bruce B. 1982. The distribution of fluted points in Arizona: review and update. Arizona State Museum, Archaeological Series 145. Tucson: University of Arizona.
- Huckell, Bruce B. 1984a. The Paleo-Indian and archaic occupation of the Tucson Basin: an overview. *The Kiva*. 49: 3–4.
- Huckell, Bruce B. 1984b. The archaic occupation of the Rosemont area, northern Santa Rita Mountains, southeastern Arizona. Arizona State Museum Archaeological Series 147. Tucson: University of Arizona.
- Huckell, Bruce B.; Huckell, Lisa W. 1984. Excavations at Milagro, a late archaic site in the eastern Tucson Basin. Manuscript on file at: Arizona State Museum, University of Arizona, Tucson.
- Huckell, Bruce B.; Huckell, Lisa W.; Fish, Suzanne K. 1995. Investigations at Milagro, a Late Prehistoric site in the Eastern Tucson Basin. Tech. Rep. 94-5. Tucson, AZ: Center for Desert Archaeology.
- Karns, Harry J., translator. 1954. *Unknown Arizona and Sonora, 1693–1721, from the Francisco Fernandez de Castillo Version of Luz de Terra Incógnita, by Captain Juan Mateo de Manje*. Tucson: Arizona Silhouettes.
- Jones, Jeffery B.; Lenhart, Austin; Stephen, David 1998. *Madera Highlands Archaeological Survey near Green Valley, Pima County, Arizona*. P.A.S.T. Cultural Resources Report No. 97859 Tucson.
- Lange, Richard C. 1999. [Untitled]. Arizona State Museum, University of Arizona. Archaeological Records: Letter.
- Lascauz, Annick. 2000. A Class III archaeological inventory for a new access road connecting Madera Canyon Road and the proposed Madera Canyon Estates site, Pima County, Arizona. SWCA Cultural Resources Rep. 2000-168. Tucson, AZ.

- Mabry, Jonathan B., ed. 1998. Archaeological investigations of early village sites in the Middle Santa Cruz Valley: analysis and synthesis. Anthropological Papers No. 19. Tucson, AZ: Center for Desert Archaeology.
- Madsen, John H. 1991. An archaeological survey of a proposed fence and pipeline on the Santa Rita Experimental Range. Archaeological Records, Arizona State Museum, University of Arizona. Archaeological Records: Letter.
- Roth, Barbara J. 1989. Late archaic settlement and subsistence in the Tucson Basin. Tucson: University of Arizona, Department of Anthropology. Dissertation.
- Sheridan, Thomas E. 1995. Arizona—a history. Tucson and London: University of Arizona Press.
- Stone, Bradford W. 2001. A cultural resources survey for two proposed improvement projects along Madera Canyon Road, approximately 12 miles southeast of Green Valley, Pima County, Arizona. Archaeological Research Services Inc. Rep. 2001-83, Tempe, AZ.
- Swartz, Deborah L. 2002. A cultural resources survey of six parcels on the Santa Rita Experimental Range, Pima County, Arizona. Project Rep. 02-159. Desert Archaeology, Inc. (DAI Project No. 02-139). Tucson, AZ.
- Teague, Lynn S. 1993. Prehistory and the traditions of the O'odham and Hopi. *The Kiva*. 58(4): 435–455.
- Van Buren, Mary; Skibo, James M.; Sullivan Alan P., III. 1992. The archaeology of an agave rasting location. In: *The Marana community in the Hohokam world*. Anthropological Papers of The University of Arizona Number 56. Tucson: University of Arizona Press.
- Willcox, David R.; Sternberg, Charles. 1983. Hohokam ballcourts and their interpretation. Arizona State Museum Archaeological Series 160. Tucson: University of Arizona.
- Willcox, David R.; McGuire, T. R.; Sternberg, Charles. 1981. Snaketown revisited. Arizona State Museum Archaeological Series 155. Tucson: University of Arizona.
- Wiley, R. R. 1979. La Canoa: a Spanish land grant lost and found. Tucson Corral of the Westerners, *The Smoke Signal* 38.

Revegetation Practices on the Santa Rita Experimental Range

Abstract: This paper discusses the revegetation activities on the Santa Rita Experimental Range since 1903. Revegetation research includes experiments to evaluate adaptation, seedbed preparation, and sowing methods. We also discuss criteria used to determine if a site has the potential for a successful revegetation. Successful revegetation was initially based on plant emergence and establishment but not persistence. Plants in successful plantings typically died or the initial stand declined substantially within about 10 years. Revegetation trials typically used native and introduced species. However, introduced species such as Lehmann lovegrass (*Eragrostis lehmanniana* Nees) more successfully established and spread. Lehmann lovegrass is invading and reducing the biodiversity of the semidesert grasslands. Scientists and others are now emphasizing revegetation with native plants. The Santa Rita Experimental Range will continue to serve as an outdoor laboratory in the search for revegetation methods, combined with the use of native species, to improve the biodiversity as well as watershed stability of the semidesert grasslands.

Keywords: Lehmann lovegrass, native plants, reseeding, seedbed, and transplanting

Acknowledgments: We would like to thank our editors, Dr. Steven Smith and Dr. Bruce Roundy, for reviewing this document and providing comments, suggestions, and collaboration in developing this document. We would also like to thank Dr. Ramona Garner for her comments. Much of the information presented in this paper was provided by the Santa Rita Experimental Range Paper Archives.

Introduction

From the late 1800s through the early 1900s woody plants increased and grasses decreased on rangelands throughout the Southwestern United States and Northern Mexico (Roundy 1995). Declining forage conditions and increased erosion led scientists and land users to attempt to develop management practices to improve the vegetation on these rangelands. Experimental ranges were created to serve as centers for the study of rangelands and development of information and practices that would protect, restore, and provide for the proper management of these environments. The Santa Rita Experimental Range (SRER) was established in 1903 to serve as an experimental range for the arid Southwest (Medina 1996). Early revegetation studies at the SRER and elsewhere in southern Arizona were conducted by D. A. Griffiths and J. J. Thornber. Griffiths' work began in southern Arizona in 1904 and utilized both native and introduced perennial forage species. He incorporated the use of furrows to concentrate and store moisture in an effort to improve plant establishment. Poor results from these plantings directed Griffiths to conclude that annual plants were better suited for revegetation of desert rangelands (Glendening and Parker 1948). In 1910 Thornber, based on his work in southern Arizona, reported that introduced forage plants were not well adapted to the desert rangelands, and that native plants that are ecologically adapted to the desert and to soils that are subject to flooding gave the best results in his trials (Glendening and Parker 1948). E. O. Wooton's revegetation trials in 1916 at the SRER supported Griffiths' and Thornber's earlier findings that, with the exception of annual filaree (*Erodium cicutarium* (L.) L'Her. ex Ait.), revegetation with introduced grasses was not likely to be successful. While revegetation studies began soon after the SRER was established (Martin 1966), a formal range revegetation program did not

Bruce D. Munda has worked for the Natural Resources Conservation Service (formerly the Soil Conservation Service) since 1975. He received a B.S. degree in agriculture (minor in watershed hydrology and range management) and an M.S. degree in agronomy and plant genetics from the University of Arizona. Contact Bruce at: Natural Resources Conservation Service, Tucson Plant Materials Center, 3241 N. Romero Road, Tucson, AZ 85705-9223; e-mail: Bruce.Munda@az.usda.gov. Mark J. Pater has worked for the Bureau of Land Management since 2002. Mark formerly worked for the Natural Resources Conservation Service (formerly the Soil Conservation Service) from 1987 to 2002. Mark received a B.S. degree in environmental resource management from Arizona State University and an M.S. degree in agronomy and plant genetics from the University of Arizona.

In: McClaran, Mitchel P.; Ffolliott, Peter F.; Edminster, Carleton B., tech. coords. Santa Rita Experimental Range: 100 years (1903 to 2003) of accomplishments and contributions; conference proceedings; 2003 October 30–November 1; Tucson, AZ. Proc. RMRS-P-30. Ogden, UT: U.S. Department of Agriculture, Forest Service, Rocky Mountain Research Station.

begin until 1935. Glendening and Parker (1948) stated that the most successful species to use in rangeland revegetation within the semidesert grassland, based on revegetation experiments at the SRER, were Boer lovegrass (*Eragrostis curvula* (Schr.) Nees), Lehmann lovegrass (*E. lehmanniana* Nees), and Wilman lovegrass (*E. superba* Peyr.). However, most revegetation trials resulted in failure. Most often this was attributed to a lack of adequate moisture for plant establishment. This led to the search to find drought-tolerant plant species for use in revegetation. Scientists and others experimented with innovative methods in seedbed preparation and evaluating introduced species in search of methods and species that would successfully revegetate severely eroding rangelands (Roundy 1995). In southern Arizona, these "miracle plants" appeared to be primarily the exotic lovegrasses from Southern Africa. Several lovegrass species were tested for revegetation use on the SRER. The most successful was Lehmann lovegrass. The revegetation program conducted by the Rocky Mountain Forest and Range Experiment Station ended on the SRER in the mid-1950s (Medina 1996).

Since 1939, the U.S. Department of Agriculture, Natural Resources Conservation Service, Tucson Plant Materials Center (PMC) has conducted plantings on the SRER. The SRER has provided the PMC with long-term evaluation sites for comparison of the potential of native and introduced species for revegetation on Southwestern rangelands. The most recent experimental planting was established in 1968. Eighteen different plantings (12 warm season and 6 cool season) were conducted at this site from 1968 through 1988. This site is located in pasture 5N south of Desert Tank on Road 401 (SW ¼ of the SW ¼ of Section 3, Township 18 south and Range 14 east). The objective of these plantings was to determine the production and erosion control potential of native and introduced species selected from the PMC testing program for the arid Southwest (USDA 1988).

Revegetation Principles

Researchers have attempted to describe factors to consider when determining if revegetation is feasible. The number of factors varies depending on the author but generally includes (1) site selection, (2) seedbed preparation, (3) species selection, and (4) seeding method (Anderson and others 1957; Jordan 1981; Martin 1966; Roundy and Biedenbender 1995). The following discussion is a review of the many efforts conducted at the SRER to enhance our knowledge of these factors.

Site Selection

Based on revegetation trials on the SRER, Anderson and others (1957) summarized the many factors to consider when determining if a revegetation effort is feasible. Site selection should be based on local climate and soil types. Sites should have medium textured soils with moderate infiltration rates, good waterholding capacities, be at least 2 ft deep, and receive 11 inches of average annual precipitation. Sites that receive less precipitation may be expected to have successful seedings only in above-average rainfall years. In drought years, even seedings on favorable sites may result in failure. Existing vegetation can indicate the

area's forage production potential. Areas with dense cover may indicate deep soils with good waterholding capacity and the potential to produce forage. Anderson and others (1957) suggested that the existing plant community may be used to determine if revegetation efforts will be successful. Stands of mesquite (*Prosopis velutina* Woot.) and burroweed (*Isocoma tenuisecta* Greene) are good indicators of sites suitable for revegetation and supporting grass. Species like saguaro (*Carnegiea gigantea* (Engelm.) Britton & Rose), palo verde (*Parkinsonia* spp. L.), triangleleafbursage (*Ambrosia deltoidea* (Torr.) Payne), and ironwood (*Olneya tesota* Gray) indicate sites that are arid and droughty and unsuited to revegetation. Dense stands of woody vegetation must be controlled before attempting to reseed. Anderson and others' (1957) research on the SRER found that if mesquite density exceeded 15 to 25 trees per acre they had to be controlled prior to revegetation. Also, if burroweed was a principal component of the plant community it would have to be removed prior to revegetation. Revegetation is seldom justified on those areas where desirable grasses remain and stand recovery can be obtained following proper grazing management practices. Reynolds (1951), based on his work at the SRER, suggested that with an appropriate rest period sandy loam soils in semidesert rangeland that have an existing 10- to 20-percent stand of Rothrock and black grama should not be recommended for revegetation with Lehmann lovegrass. Reynolds suggested that a rest period of 8 to 10 years is needed on these sites for native grass stands to recover to similar forage production as similar-aged stands of seeded Lehmann lovegrass. Cox and Jordan (1983), from their rangeland revegetation work in southeastern Arizona, suggested that revegetation should be discontinued in the Chihuahuan Desert if it is based on an expected gain in livestock numbers. They stated that a successful seeding can be expected in 1 of 10 years in the Chihuahuan Desert of southeastern Arizona, and that forage production from a successful seeding can be expected to decline over a 10-year period. Sites heavily infested with cholla and pricklypear cacti (*Opuntia* spp. P. Mill.) are seldom suitable for revegetation because the physical manipulation required to prepare the seedbed would aid in dissemination of cactus propagules and increase their density. Martin (1966) stated that competitors, especially woody plants, should be removed or controlled prior to revegetation. Livingston and others (1997) found that Bush muhly (*Muhlenbergia porteri* Scribn. ex Beal) had greater density and cover under overstory woody species compared to open areas on their research plots at the SRER, suggesting that shade-tolerant species may emerge and persist if seeded under overstory plants.

Selection of revegetation sites should incorporate proper management of the site after revegetation. Revegetation sites should be rested from grazing for at least 1 to 2 growing seasons to allow young plants to become established. The site should be managed so that livestock or other grazers are not allowed to concentrate and overutilize the reseeded area. When planning a revegetation project, care should be given to its size so the reseeded area can be incorporated into the overall management plan and be properly managed. Also, indigenous fauna (rodents and rabbits) can have a significant impact on the success of a revegetation project (Anderson and others 1957), especially small revegetation projects.

Jordan (1981) summarized that site selection should be based on climate, soils, and terrain. The site must have the

potential for successful establishment and ability to support the proposed revegetation. The terrain and soil types must be suitable to support the desired vegetation change. Shallow, coarse, rocky, saline, and or alkaline soils should be avoided, as should terrain with slopes above 30 percent.

In southern Arizona, Jordan (1981) proposed that seeding sites should ideally receive an average of 5.5 inches of precipitation in July, August, and September and at least 11 inches of average annual precipitation to be considered for potential revegetation. In his summary of revegetation activities on the SRER, Martin (1966) indicated that seeding should take place in May or June prior to the start of the summer rainy season. Roundy and others (1993) conducted laboratory germination experiments with regard to seeding depth and water availability for three grasses used in semi-desert revegetation. Their results indicated that these grasses required frequent rainfall events for establishment. Lack of frequent rainfall events may be one reason many of the revegetation activities in the Southwest have poor results. Research by Abbott and Roundy (1995) on the SRER suggested that native grass seedings should take place the third week of July to increase the chance of successful establishment. They found that native grasses germinated faster than Lehmann lovegrass, especially when sown as naked caryopsis. By waiting to seed until the third week of July there is a greater opportunity of receiving rainfall events that are 5 days apart or less.

Seedbed Preparation

Wooton's revegetation recommendations based on research conducted between 1913 and 1916 on the SRER were to broadcast native seed onto bare ground without preparing the seedbed (Glendening and Parker 1948). Wilson's work, conducted from 1927 to 1931 in southern and central New Mexico, determined that the best revegetation results were obtained by seeding just prior to summer rains with little or no seedbed treatment except when a mechanical treatment was needed to control competition (Glendening and Parker 1948). Bridges work (Glendening and Parker 1948) from 1938 to 1941 in southern New Mexico indicated that seedbed preparation was necessary to ensure a successful revegetation. The equipment he used was a two-row lister followed by a 6-ft drill. Glendening and Parker (1948) stated that the eccentric disk-cultipacker seeder, developed by the Soil Conservation Service, was the best piece of equipment for preparing the seedbed and seeding. On sandy soils, successful revegetation has been achieved by broadcasting directly onto the soil surface (Glendening and Parker 1948).

Range trials in 1951 used a Krause cutaway disc to prepare the seedbed, tilling to a depth of 2 to 4 inches. This seedbed preparation implement was commonly used in the 1950s prior to broadcast seeding and cultipacking (Reynolds 1951). Martin (1966) suggested that planting methods should ensure proper seed placement in the soil surface, ¼ inch for fine-seeded species and up to 1 inch deep for large-seeded species, and promote moisture penetration into the soil. Successful seedbed preparation methods include pitting, contour furrowing, ripping, and imprinting (Reynolds and Martin 1968). Slayback and Cable (1970) conducted a 4-year trial to evaluate the effectiveness of "intermediate pits" and conventional pits on three different soil types (sandy loam,

loam, and clay loam) on the SRER at the old PMC site that was north of the intersection between roads 505 and 401. The conventional pits were constructed using a standard pitting disc, creating a pit that was 18 to 24 inches long, 12 inches wide, and 6 inches deep. Intermediate pits were constructed with the basin-forming machine developed by Frost and Hamilton (1964) (fig. 1), which created broad, shallow pits 5 ft wide, 5 to 6 ft long, and 6 inches deep. The intermediate pit was developed to create pits that had a longer effective life. Conventional pits were effective for initial plant establishment, but they filled with soil after intense rainfall events and lost their ability to concentrate water within the first year or two. The average forage production over a 4-year period was 2½ times greater in the intermediate pit (basins) as in the standard pit (Martin and Cable 1975). Slayback and Renney (1972) compared bulldozer pits, reportedly similar to the pits made by the Frost basin-forming machine, to conventional pits or interrupted contour furrows, and their brand of "intermediate pits" (fig. 2) at the current PMC site located approximately 1 mile south of Desert Tank on road 401. Slayback and Renney's intermediate pits differed from Frost's intermediate pits primarily in the type of equipment used to construct them. Slayback and Renney used a tractor with a three-point hitch-mounted blade to form pits that were approximately the same size as the pits formed by Frost's basin forming machine. A range-land drill was used to sow the seeds into the pits compared to Frost's machine that formed pits and planted the seed in a single operation. Herbage production and stand counts were taken over the 4-year planting effort. Their results indicate that the intermediate pit was more effective with

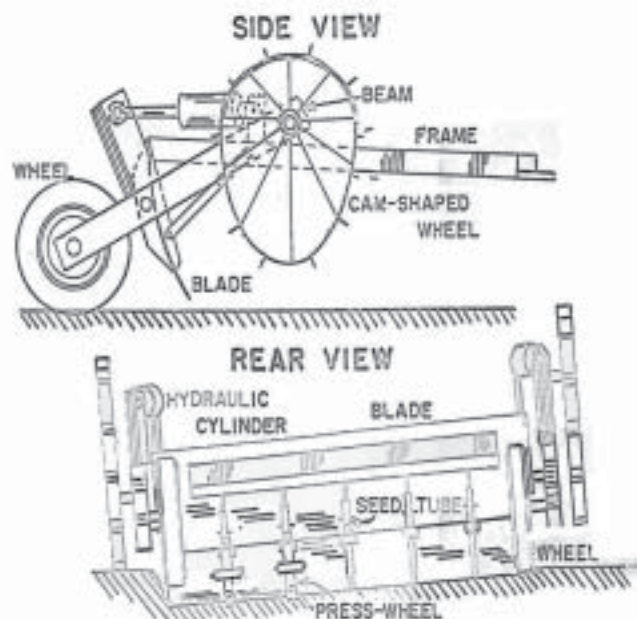

Figure 1—Frost basin-forming machine (from K. R. Frost and L. Hamilton, publication date and source unknown). Reclaiming semidesert land by planting perennials in basins on uncultivated soils (available in Paper Archives at U.S. Department of Agriculture, Natural Resources Conservation Service, Tucson Plant Materials Center).

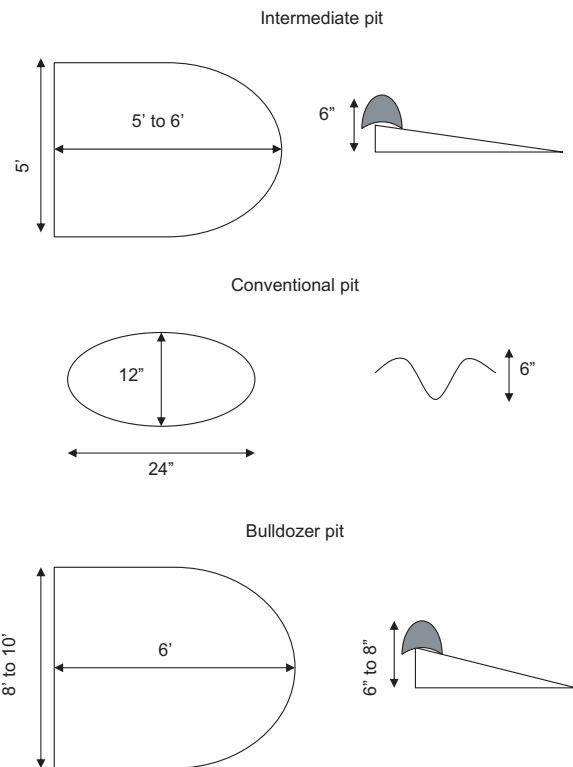

Figure 2—Pit types used on the Santa Rita Experimental Range by NRCS at the Desert Tank planting site (adapted from Slayback and Cable 1970).

regard to stand establishment and forage production than the conventional pit and the bulldozer pit treatments.

At the current SRER PMC site, one or more seedbed treatments were incorporated in all experimental plantings from 1968 to 1988. Treatments included intermediate pits, disking, or contour furrowing after ripping. Intermediate pits were created as described by Slayback and Renney (1972) along a 200-ft row perpendicular to the slope. Intermediate pits were used in 11 of the 18 plantings at the PMC site, while only three plantings used the disked treatments and only one used the furrowed following ripping treatment. Only two planting dates (1983 and 1984) resulted in good stand establishment and persistence of seeded species using the intermediate pits. The disked seedbed treatment had similar results with regard to percent stand and persistence in most plantings, but in the 1982 planting the stand persistence was much lower than the intermediate pits.

Cattle trampling has been another method recommended for preparing a seedbed that would encourage seedling establishment (Winkel and Roundy 1991). In the Altar Valley south of Three Points, Winkel and Roundy (1991) compared seedling emergence using cattle trampling, land imprinting, and ripping as seedbed preparation treatments. They found in years where summer precipitation provided available soil surface water for at least 3 weeks, land imprinting and heavy cattle trampling increased plant emergence for Blue panic (*Panicum antidotale* Retz.) and "Cochise" atherstone lovegrass (*Eragrostis trichophora* Coss. and Dur.). In years where summer precipitation provided available soil

water for 6 to 9 days, they found that seedbed treatments with the greatest disturbance (heavy trampling, land imprinting, and ripping) produced higher emergence than no disturbance or light disturbance treatments. In years where the available soil water was only 2 to 3 days, emergence was low for all seedbed treatments. Winkel and Roundy (1991) suggested that seedbed disturbance may be unnecessary in wet years and provide little benefit for plant establishment in dry years, depending on soil type and seed size of sown species (Winkel and others 1991).

Species Selection

Early revegetation work in southern New Mexico by Bridges, working from 1938 to 1941, determined that the most successful species for revegetation (of the 118 tried) were Rothrock grama (*Bouteloua rothrockii* Vasey), Boer and Lehmann lovegrass, and fourwing saltbush (*Atriplex canescens* (Pursh) Nutt.) (Glendening and Parker 1948). In the semidesert grassland of southern Arizona the best adapted species were Boer, Lehmann, and Wilman lovegrass (Glendening and Parker 1948).

Glendening (1937) conducted and evaluated several revegetation trials at the SRER from 1933 to 1937. These included irrigation, use of mulch, seedbed cultivation, winter seeding, seeding with native hay, seeding with annuals, transplanting, and revegetation using transported topsoil. The following is an overview of this work.

All of the trials were initiated in 1935 except as noted. An irrigated seeding trial used 24 small seedbeds (1 m²) that were sown to either mixtures or pure stands of the following species: black grama (*Bouteloua eriopoda* (Torr.) Torr.), hairy grama (*B. hirsuta* Lag.), slender grama (*B. repens* (Kunth) Scribn. & Merr), sprucetop grama (*B. chondrosioides* (Kunth) Benth. ex S. Wats), Rothrock grama, sideoats grama (*B. curtipendula* (Michx.) Torr.), and parry grama (*B. parryi* (Fourn.) Griffiths); bush muhly and Arizona cottongrass (cottontop) (*Digitaria californica* (Benth.) Henr.). Plots were sown in early July and hand irrigated for approximately 2 weeks, or until the start of the summer rains. Excellent stands of all the grasses were obtained except black grama and bush muhly. Poor seed quality was the main reason cited for the performance of black grama. After 2 years the established plants were spreading vegetatively. Glendening indicated that if a source of viable seed could be developed black grama would be an excellent species for revegetation due to its ability to persist and spread on poor soils. Glendening considered bush muhly a very poor species to be used in revegetation due to its poor emergence characteristics.

A mulch trial incorporated four (10 by 10 ft) plots that were totally protected from grazing. Plots were seeded to different species after the start of the summer rains. One-half of each plot was covered with 1 inch of barley (*Hordeum vulgare* L.) straw. Grass species used were slender, Rothrock, and sideoats grama; and tanglehead (*Heteropogon contortus* (L.) Beauv. ex Roemer & J.A. Schultes). Seed was applied to the bare undisturbed soil surface. An excellent stand was obtained for each grass plot with mulch. The plots without mulch had little to no emergence or plant establishment (fig. 3). A seedbed cultivation trial was installed in June 1936 prior to the start of the summer rains. A 500-ft² plot was seeded to a mixture of Rothrock, slender, and sprucetop grama, and

Mulch trial (1935)

Species	Number of seedlings per square foot ¹							
	Flot I		Flot II		Flot III		Average	
	Littered ²	Bare	Littered ²	Bare	Littered ²	Bare	Littered ²	Bare
Slender grama	33	0	22	0	26	2	27	1*
Rothrock grama	6	0	5	0	27	0	13	0
Side-note grama	42	0	39	1*	14	0	32	1*
Tanglehead	3	0	4	0	1	0	1	0
Average							17	1*

¹Count made 30 days after seed was planted.
²Less than 1 seedling to the square foot.

Figure 3—“Germination upon bare ground and under artificial litter” (Mulch trial 1935; Glendening 1937).

tanglehead, Arizona cottontop, and bush muhly. The plots were hand raked to disturb the soil to a depth of 1 inch, and half of the plot was lightly covered with mulch. Emergence was good despite poor summer rainfall. The mulch-covered portion of the plot had the best emergence, but it was not as dramatic as the previous trial where the seed was sown on the bare soil without disturbance. This trial indicates that cultivation may offset the lack of litter on the soil surface. A similar trial sown in August 1936 compared three treatments: mulch, raked topsoil, and a control. The species from the previously described planting were used in addition to sideoats and black grama. Due to late planting and limited precipitation few plants established. Plots with mulch had the greatest number of seedlings though. A winter seeding trial was sown on December 5, 1935, onto a 2,500-ft² plot. The seed mixture included Rothrock, slender, sideoats, and black grama, bush muhly, tanglehead, and Arizona cottontop. The plot had raked and unraked soil surfaces for seedbed treatments. The raked treatment involved cultivating to a depth of about 2 inches, sowing the seed, and then lightly raking to cover the seed. This trial was apparently a failure due to temperatures being too low for germination. This trial was repeated in January 1937 using the same species and treatments with the inclusion of mulch on one-third of the plot. The same results were obtained with no germination or emergence noted.

A native grass hay trial was conducted during the summer of 1936. During 1935 a native grass stand (sideoats, slender, and sprucetop grama, cottontop, and feathergrass (*Chloris virgata* Sw.) was cut when the seed was reaching maturity. The hay was stored and then spread over the study area in 1936. Emergence was good, but plant survival was low by the end of the summer due to below normal summer rainfall. Glendening felt strongly that the use of mulch or grass hay was one of the most promising seeding methods for revegetation of desert rangelands. A winter annual trial included: indianwheat (*Plantago ovata* Forsk.), California poppy (*Eschscholzia californica* Cham.), filaree, fiddleneck (*Phacelia* spp. Juss.), mustards (*Descurainia* spp. Webb & Berth. and *Lepidium* spp. L.), and sixweeks fescue (*Vulpia octoflora* var. *octoflora* (Walt.) Rydb.). Two plantings were conducted

(September and October) in 1935 at the Gravelly Ridge site, which is almost due south of the present Continental Grade School on the highway 62. Treatments included the application of mulch over seeds that were sown on bare soil, cultivating the soil prior to sowing, and sowing seeds on bare undisturbed ground. Emergence was good for all treatments due to good November and December rainfall. Rainfall was poor for the months of January through March. The best growth was obtained with the cultivated plot, and the poorest was associated with the bare undisturbed plot.

Glendening's (1937) observations from these SRER trials are summarized below:

Native forage grasses

1. Arizona cottontop, and Rothrock, slender, sprucetop, and hairy grama were the best performers. Black grama, curly mesquite (*Hilaria belangeri* (Steud.) Nash), and bush muhly were typically difficult to establish.

2. Seeding should be conducted at the beginning or just prior to the summer rainy season.

3. Mulch can improve germination, especially on eroded soils. Cultivation and seed incorporation into the soil helps enhance germination but not as much as mulch.

4. Due to erratic precipitation, natural reproduction of native grasses does not occur except in years of average or above average precipitation.

Winter annuals

1. Good stands can be expected from sowing annual species common to Arizona.

2. Winter annuals should be fall planted prior to winter rains.

3. Repeated plantings of annuals should not be required due to their ability to produce seed even during seasons with low precipitation.

4. Cultivation appears to increase germination, but it is not necessary. The application of mulch has no apparent effect on germination but does help overall plant growth.

5. Annuals are generally easy to establish, even on poor soils. Although they can provide some forage they add mulch to the soil that should improve the condition of the soil where grasses could become established.

Glendening (1935) evaluated the use of grass sod in his first transplant trials at the SRER. He indicated that transplanting is a feasible method for small areas but not practical for large areas. Species used in his transplant trial included pearl millet (*Pennisetum glaucum* (L.) R.Br.), bush muhly, tanglehead, Arizona cottontop, poverty threeawn (*Aristida divaricata* Humb. & Bonpl. ex Wild.), small or Santa Rita threeawn (*Aristida californica* Thurb. ex S. Wats var. *glabrata* Vasey), and slender, sideoats, black, and Rothrock grama. Transplants were either dug directly from the field or grown as potted plants. Field-dug plants were placed into flats and taken directly to the trial site and planted (fig. 4). Potted plants were handled the same except plants were taken from the flats and planted into tar-paper pots at the nursery. Potted plants were watered until they were transplanted into the field. It is interesting to note that the potted plant method was considered more time consuming and costly compared to the field-dug plants. Treatments included three planting times (spring, summer, and fall) along with either complete protection from all grazing or protection from livestock grazing only. In June 1935, about



Figure 4—“Small plots 1 by 2 m were transplanted to native grasses. The plants were set out in rows. The rocky nature of the soil made it necessary to use a heavy pick to dig the furrows” (Glendening 1937).

4,000 field-dug plants were transplanted (spring planting) at three study sites on the SRER and irrigated for 3 weeks until the start of the summer rainy season. Transplants were generally planted the same day and never held for more than 24 hours. Five months after transplanting 57 percent of the transplants had established, and 18 months after planting 46 percent of the plants had persisted (fig. 5). The

Species planted	Number planted June 15, 1935	Percentage established November 1935	Percentage survival after 18 months
		percent	percent
<i>Heteropogon contortus</i>	11	100	100
<i>Bouteloua filiformis</i>	266	91	81
<i>Bouteloua chondrosioides</i>	485	72	92
<i>Hilaria belangeri</i>	285	65	23
<i>Aristida californica</i>	325	65	36
<i>Chaetochloa griebachii</i>	385	64	35
<i>Bouteloua rothrockii</i>	490	61	59
<i>Bouteloua curtipendula</i>	330	60	31
<i>Valota saccharata</i>	350	52	40
<i>Bouteloua eriopoda</i>	725	40	44
<i>Aristida divaricata</i>	350	29	24
<i>Muhlenbergia porteri</i>	70	17	4
Total	4013	57	46

Figure 5—“Percentage of grasses established by transplanting during the spring, with artificial irrigation” (Glendening 1937). *Bouteloua filiformis* syn. *Bouteloua repens*, *Aristida californica* syn. *Aristida californica* var. *glabrata*, and *Valota saccharata* syn. *Digitaria californica*.

summer planting was conducted after the rains started in mid-July 1935 (fig. 6). This planting incorporated three planting sites and 8,500 field-dug plants, which were watered only once at the time they were transplanted. Each planting site had three plots, two with complete grazing protection and one protected from livestock grazing only. Six weeks after planting, one plot was fertilized with a mixture of sodium nitrate and ammonium sulfate. Six months after planting the overall establishment was 58 percent, and after 14 months survival fell to 28 percent. There was no apparent difference between the fertilized and unfertilized plots after 4 months, but after 14 months there was higher survival on the protected unfertilized plots. Plant establishment was much lower on the control plots due to grazing by rodents (fig. 7). The species that had the best establishment on the control plot was tanglehead. Low establishment, for all planting dates and treatments, was believed to be due to low summer rainfall in 1936 followed by a lack of spring precipitation in 1937. Fall transplant trials were initiated in August 1936 and December 1936. Species from the previously described planting were used except the transplants were nursery potted plants. The initial results for the August planting were favorable (fig. 8). Persistence was low, however, due to heavy grazing from rodents that eventually killed the plants. The winter planting met with similar results in that survival and establishment were very low.

Topsoil transplanting was also evaluated by Glendening in 1935 and 1936 at the SRER. Topsoil was removed from well-grassed areas and spread 3 inches deep onto denuded areas where the topsoil had eroded away. Topsoil applications were conducted in July of 1935 and 1936. In both cases fair plant growth was observed. Annuals comprised most of the growth, but a few perennial grasses also germinated and established.

Glendening (1937) summarized his transplanting results as follows:

1. Transplanting of native grasses is feasible under proper weather conditions and can be used to establish perennial



Figure 6—“Grasses transplanted during the summer of 1935 made good growth and many of them set seed during the fall” (Glendening 1937).

-Percentage of grasses established by transplanting during the summer of 1935.

Species	Number planted July 15, 1935				Percentage established November 1935				Percentage survival after 24 months			
	CP	CF	TP	Total	CP	CF	TP	Total	CP	CF	TP	Total
	fert.	fert.	fert.		percent	percent	percent	percent	percent	percent	percent	percent
<i>Bouteloua rothrockii</i>	263	271	299	833	85	90	94	90	5	41	60	36
<i>Valota saccharata</i>	226	161	188	575	65	89	94	81	26	64	86	57
<i>Heteropogon contortus</i>	210	162	171	543	70	67	86	76	40	65	80	62
<i>Bouteloua filiformis</i>	290	288	279	857	64	77	76	73	7	44	50	33
<i>Chaetochloa grisebachii</i>	186	175	181	542	66	61	65	64	11	43	37	30
<i>Bouteloua curtipendula</i>	206	150	158	514	51	64	69	61	12	49	43	35
<i>Muhlenbergia porteri</i>	166	163	164	493	67	52	54	58	11	31	39	27
<i>Bouteloua chondrosioides</i>	115	290	311	716	45	60	47	50	6	27	50	27
<i>Bouteloua eriopoda</i>	296	208	294	898	34	49	44	42	1	35	23	19
<i>Aristida divaricata</i>	251	166	151	568	31	52	44	41	5	17	46	26
<i>Aristida californica</i>	309	290	294	893	49	43	21	38	5	8	14	9
<i>Hilaria belangeri</i>	301	295	302	898	46	29	34	36	0	8	22	30
Total	3043	2726	2822	8591	55	60	59	58	9	32	45	28

1. Protected from cattle grazing
2. Protected from cattle and rodent grazing and fertilized
3. Protected from cattle and rodent grazing but not fertilized.

-Percent of grasses established by transplanting during the summer of 1936

	Number planted August 1936			Percentage established April 1937		
	CP	CF	Total	CP	CF	Total
	percent	percent	percent	percent	percent	percent
<i>Trichachne californica</i>	100	50	150	97	96	97
<i>Bouteloua filiformis</i>	200	100	300	74	93	80
<i>Heteropogon contortus</i>	100	50	150	80	64	75
<i>Bouteloua chondrosioides</i>	200	100	300	60	91	70
<i>Aristida californica</i>	200	100	300	60	70	64
<i>Bouteloua rothrockii</i>	200	100	300	47	94	63
<i>Chaetochloa spp.</i>	100	50	150	43	76	54
<i>Aristida divaricata</i>	100	50	150	42	72	52
<i>Bouteloua eriopoda</i>	200	100	300	44	63	50
<i>Bouteloua curtipendula</i>	100	50	150	27	74	43
<i>Hilaria belangeri</i>	200	100	300	13	39	22
<i>Muhlenbergia porteri</i>	100	50	150	12	34	19
Total	1800	900	2700	50	76	58

Figure 8—"Percent of grasses established by transplanting during the summer of 1936" (Glendening 1937). *Bouteloua filiformis* syn. *Bouteloua repens*, *Aristida californica* syn. *Aristida californica* var. *glabrata*, *Trichachne californica* syn. *Digitaria californica*, and *Chaetochloa* spp. syn. *Setaria* spp.

grasses on sites where direct seeding cannot be accomplished successfully.

2. Transplanting should be done in July at the start of the summer rainy season.

3. Direct field transplants have performed as well as potted nursery stock. Potted nursery stock may have some advantages when used in low rainfall areas or on poor soils.

4. Transplanting topsoil from well-grassed areas to badly eroded sites can be successful.

5. Transplanting soil should be done in late spring prior to summer rains to provide the opportunity for perennial grass seed present in the topsoil, to germinate with the summer rains.

6. Topsoil should be acquired from areas supporting grass that naturally reproduce from seed. Sites dominated by curly mesquite and black grama should be avoided due to a lack of a viable soil seed bank.

Glendening installed four trials in the Middle Tank Revegetation Plot, Study Area 205 at the SRER from 1940 to 1948. The four trials were (1) species adaptation, (2) planting methods (discussed under seeding methods), (3) compatible mixture, and (4) grazing (not discussed here).

The species adaptation trial used 50 native and introduced species, mostly grasses. Most of the accessions were acquired from the Tucson Plant Materials Center (table 1). Three treatments were used in this two-replication trial: (1) row plantings, (2) contour furrows, and (3) contour furrows with mulch. The row planting treatment involved hand planting of each species in three 12-ft rows spaced 1 ft apart. The contour furrow treatment used furrows that were 3 to 4 inches deep in 12-ft lengths and on 16-inch centers. Seed was sown and covered by hand. Contour furrows with mulch were installed in the same manner as the contour furrow treatment with mulch applied to the soil surface after seeding. Due to below average rainfall in 1946 and 1947, replanting was done in 1947 and 1948. The May 1949 evaluation indicated that many of the replants failed, especially buffelgrass (*Pennisetum ciliare* (L.) Link). Hall's panic (*Panicum hallii* Vasey) was one of the few replanted accessions found growing in 1949, and African lovegrass (*Eragrostis echinocloidea* Stapf.) and weeping lovegrass (*E. curvula* (Schrad.) Nees) had all but disappeared. Plants survived better on the contour furrows than on the row plantings. The only remaining shrub was rough menodora (*Menodora scabra* Gray). In general, the best performing species were Lehmann, Boer, and Wilman lovegrasses, and Arizona cottontop, and tanglehead (table 2).

A compatible mixture trial evaluated various grasses, mixed with Lehmann lovegrass at different seeding rates or seeded as a single species. The seedbed was prepared by double disking, harrowing to remove plant debris, and installing contour furrows 4 to 6 inches deep at 2-ft intervals. A cyclone seeder was used to broadcast the seed. No seed incorporation treatment was used. Seedings were conducted in July 1946 and repeated in July 1947 due to poor stand establishment from the 1946 planting. The 1947 planting compared Wilman lovegrass, Lehmann lovegrass, and Arizona cottontop at differing seeding rates (table 3a). Comments on the July 1947 planting were that due to below average rainfall this planting had a very poor stand. A second July 1947 planting compared six accessions (Lehmann, Wilman and Boer lovegrasses, and Arizona

Table 1—Species adaptation trials: species list for July 1946 planting. Middle Tank Reseeding Plot, Study Area 205 (adapted from Glendening and others 1946).

Species	SCS accession number
<i>Bothriochloa barbinodis</i>	A 11495
<i>B. ischaemum</i>	A 1407
<i>Dichanthium sericeum</i> (R.Br.)A. Camus	A 11812
<i>Astrebula elymoides</i> Bailey & F.Muell. ex F.M. Bailey	A 1335
<i>A. lapacea</i> (Lindl.) Domin	A 8839
<i>Atriplex canescens</i>	A 5099
<i>A. nummularia</i> Lindl.	A 30
<i>Bouteloua curtipendula</i>	A 2969
<i>B. eludens</i> Griffiths	A 11563
<i>B. eriopoda</i>	A 5066
<i>B. gracilis</i> (Willd. Ex Kunth) Lag. ex Griffiths	A 121424
<i>B. hirsuta</i>	A 10216
<i>B. radicata</i> (Fourn.) Griffiths	A 11327
<i>Calliandra eriophylla</i> Benth.	A 11672
<i>Chloris berroi</i> Arech.	A 2086
<i>C. cucullata</i> Bisch.	A 2977
<i>Eragrostis bicolor</i> Nees	A 11958
<i>E. brigantha</i> (author not found)	A 620
<i>E. curvula</i>	A 84
<i>E. curvula</i>	A 67
<i>E. echinocloides</i>	A 11960
<i>E. intermedia</i> A.S. Hitchc.	A 8028
<i>E. lehmanniana</i>	A 68
<i>E. lehmanniana</i> var. <i>ampla</i> (author not found)	A 11961
<i>E. superba</i>	A 11965
<i>Krashennikovia lanata</i> (Pursh) A.D.J. Meeuse & Smit	Commercial
<i>Heteropogon contortus</i>	Number not given
<i>Hilaria belangeri</i>	A 3323
<i>Pleuraphis mutica</i> Buckl.	A 8772
<i>Krameria erecta</i> Willd. Ex J.A. Schultes	A 2284
<i>Leptochloa dubia</i>	A 11695
<i>Lycurus phleoides</i> Kunth	A 10217
<i>Medicago lupulina</i> L.	Commercial 3460
<i>Menodora scabra</i>	A 2408
<i>M. scabra</i>	A 2390
<i>M. longiflora</i> Gray	A 9126
<i>Muhlenbergia porteri</i>	A 2346
<i>Achnatherum hymenoides</i> (B.L. Johnson) Barkworth	A 2691
<i>Piptatherum miliaceum</i> (L.) Coss.	A 1895
<i>Panicum hallii</i> Vasey	A 8002
<i>P. prolutum</i> F. Muell.	A 2664
<i>Pappophorum vaginatum</i> Buckl.	A 8666
<i>Paspalum setaceum</i> Michx.	A 149
<i>Pentzia incana</i> (Thunb.) Kuntze	A 149
<i>Pennisetum ciliare</i>	A 2348
<i>P. orientale</i> (Willd.) L.C. Rich.	A 131
<i>Setaria vulpiseta</i>	A 9051
<i>Sporobolus airoides</i> (Torr.) Torr.	A 920
<i>S. contractus</i> A.S. Hitchc.	A 11569
<i>S. cryptandrus</i> (Torr.) Gray	A 810
<i>S. fimbriatus</i> (Trin.) Nees	A 69 & A 72
<i>S. flexuosus</i> (Thrub. Ex Vasey) Rydb.	A 10117
<i>Digitaria californica</i>	A 8084
<i>Tridens muticus</i> (Torr.) Nash var. <i>elongatus</i> (Buckl.) Shinnery	A 3014
<i>T. muticus</i> (Torr.) Nash var. <i>muticus</i>	A 11321
<i>Erioneuron pilosa</i> (Buckl.) Nash	A 9456
<i>Vicia americana</i> Muhl. ex Willd.	Commercial
<i>V. villosa</i> Roth	Commercial

Table 2—Species adaptation trial and stand rating as of May 1949. Middle Tank Reseeding Plot, Study Area 205 (adapted from Glendening and others 1946).

Species	Type of planting		
	Flat or row	Furrow	Furrow and mulch
<i>Heteropogon contortus</i>	Good	Excellent	Excellent
<i>Eragrostis curvula</i>	None	Very good	Very good
<i>E. superba</i>	Very poor	Good	Good
<i>E. lehmanniana</i>	Fair	Good	Good
<i>E. lehmanniana-Ampla</i>	Poor	Fair	Fair
<i>Pennisetum ciliare</i>	Poor	Good	Poor
<i>Digitaria californica</i>	Fair	Fair	Good
<i>Bothriochloa ischaemum</i>	None	Poor	Poor
<i>Bouteloua repens</i>	None	None	Poor
<i>Panicum hallii</i>	None	None	Poor
<i>Setaria macrostachya</i>	None	None	Poor
<i>Leptochloa dubia</i>	None	None	Trace

Table 3a—Compatible mixture trial, July 23, 1947. Middle Tank Reseeding Plot, Study Area 205 (adapted from Glendening and others 1946).

Species	Seeding rate (lb per acre)	Subplot number
Wilman lovegrass	6	1
Lehmann and Arizona cottontop	3 and 8	2
Wilman and Arizona cottontop	2 and 8	3
Lehmann	3	4
Lehmann and Arizona cottontop	1 and 8	5
Wilman and Arizona cottontop	6 and 8	6
Lehmann and Arizona cottontop	1 and 8	7
Lehmann and Arizona cottontop	3 and 8	8
Wilman	6	9
Wilman and Arizona cottontop	6 and 8	10
Lehmann	3	11
Wilman and Arizona cottontop	2 and 8	12

Table 3b—Compatible mixture trial, July 30, 1947 Middle Tank Reseeding Plot, Study Area 205 (adapted from Glendening and others 1946).

Species	Seeding rate (lbs per acre)	Subplot number
Boer lovegrass	Not shown	A
Arizona cottontop	Not shown	B
Lehmann and Boer and sand dropseed	1, 2, 2	C
Lehmann and Slender grama	-, 3	D
Wilman lovegrass	Not shown	E
Lehmann and slender grama	2, 3	F

cottontop, sand dropseed, and slender grama) at different seeding rates (table 3b). Comments on this July 1947 planting were that a good stand of Lehmann lovegrass and slender grama had emerged, but due to low precipitation in 1948 the established plants for both July 1947 plantings failed to persist (USDA 1947–1948).

In the early 1950s, several plantings were installed in Pasture 140 by H. G. Reynolds, similar to those planted in study area 205 (Reynolds 1952). In July 1951 a three-species mixture trial was sown in Pasture 140. The mixture trial incorporated combinations of Lehmann, Boer, and Wilman lovegrass. The site was cleared of mesquite and the seedbed prepared with the Krause cutaway disc. A hand-held whirlwind seeder was used to broadcast the seed, and all plots were cultipacked. In July 1951, a yield study was planted that used nine different species (table 4). This planting was repeated in July 1952 with minor changes in species used. All species were broadcast seeded followed by a cultipacking. The best performing species was plains bristlegrass (*Setaria vulpiseta* (Lam.) Roemer & J.A. Schultes) because it had better overall emergence. Results for these three plantings were not definitive with comments indicating that all three trials were considered failures. Lack of rainfall in 1951 and 1952 (60 percent of average) was indicated as the primary reason for failure.

Martin (1966) states that based on results from experiments conducted on the SRER the best adapted plants for range revegetation include the introduced species Lehmann, Boer, and weeping lovegrass, and the native species Arizona cottontop, black grama, and sideoats grama with Lehmann and Boer lovegrass considered most reliable. Lehmann lovegrass is considered easier to establish but not as palatable or as long lived as Boer lovegrass. Arizona cottontop, black grama, weeping lovegrass, and sideoats grama were considered viable choices but are more difficult to establish. Weeping lovegrass and sideoats grama are considered suitable for upland sites that receive more moisture or where soils stay moist for a longer period of time. For areas where water accumulates such as swales, blue panic, Johnsongrass (*Sorghum halepense* (L.) Pers.), and Boer, and Lehmann lovegrass are adapted species (Reynolds and Martin 1968). Wilman lovegrass is another suitable species but only in those areas where winter temperatures do not fall below 10 °F. Lehmann lovegrass is generally the only species recommended for upland areas that receive less than 14 inches of precipitation. Martin stated in his 1966 report that adapted species and successful seeding methods have not been developed for areas below 11 inches of annual precipitation (Martin 1966).

Jordan (1981), based on his research conducted in southern Arizona, developed additional criteria to be considered

Table 4—Yield trial-species list, July 11, 1951. Pasture 140 (adapted from Glendening and others 1946).

Species	Accession	Planting rate (lb per acre)
<i>Bouteloua eriopoda</i>	Flagstaff-1949	40
<i>B. repens</i>	A10123-2172	10
<i>Eragrostis bicolor</i>	A11958-II26	2
<i>E. lehmanniana</i>	A68-2168	1
<i>Heteropogon contortus</i>	SRER 1939	5
<i>Muhlenbergia porteri</i>	A8368	25
<i>Panicum hallii</i>	A8002-2158	3
<i>Sporobolus cryptandrus</i>	Mixed lots 40-41	1
<i>Digitaria californica</i>	A8084-1718-49	12

when selecting species for rangeland revegetation. Included among these were (a) germination rate—species that can germinate in 3 days are better adapted to limited moisture conditions than those species requiring 5 days; (b) species should have good seedling vigor; (c) when revegetation conditions are favorable adapted native species should be used. However, if the site does not have all the favorable conditions, an introduced species may be a better choice; and (d) selected species must be commercially available. A species' commercial availability is directly related to not only its field performance but how much seed it yields, seed production requirements, ease of harvest, seed conditioning requirements, and ability to be sown with currently available equipment. Current research suggests that slower germination, mimicking the conservative germination behavior of Lehmann lovegrass, may improve the potential for emergence and establishment of native species (Abbott and Roundy 2003; Biedenbender and Roundy 1996; Roundy and Biedenbender 1995).

The PMC plantings conducted on the SRER from 1968 through 1970 utilized 12 lovegrass accessions and 2 accessions of buffelgrass and incorporated yellow bluestem (*Bothriochloa ischaemum* (L.) Keng) in the 1969 summer planting. Overall results from these plantings showed that common buffelgrass, T-4464, had the greatest forage production, but it was not significantly higher than the lovegrasses A-1739 and A-17340 or Lehmann lovegrass A-16651, or yellow bluestem. The final evaluation, conducted in 1973, found that "Palar" Wilman lovegrass and a commercial strain of Wilman lovegrass were considered the two best performers in these plantings based on forage production, basal cover, and plant density.

Small observational trials were planted in the fall of 1968, 1969, and 1971. Species were planted using mechanical push planters and seeded into intermediate pits. Sixteen accessions of native and introduced shrubs and forbs were included in these trials. Results from the 1968 and 1969 plantings indicated fair to good overall emergence, but none of the species survived due to dry winters. Two accessions of rough menodora and prostrate kochia (*Kochia prostrata* (L.) Schrad) were sown with two accessions of ballonpea (*Sutherlandia frutescens* (L.) R.Br.). Galleta grass (*Pleuraphis jamesii* Torr.) was included with the above-mentioned species. The final (1979) evaluation indicated that prostrate kochia—A-18219, and rough mendodora—A-17773, from Pomerene, AZ, were the better performers. However, established accessions from both plantings were rated as poor with regard to overall stand, forage production, and erosion control.

In 1980 the PMC installed a summer and fall planting at the PMC planting site on the SRER. The 1980 summer planting included shrubby senna (*Senna corymbosa* (Lam.) Irwin & Barneby), Colorado four o'clock (*Mirabilis multiflora* (Torr.) Gray), spike muhly (*Muhlenbergia wrightii* Vasey ex. Coult.)—A-8604 and "El Vado," green sprangletop (*Leptochloa dubia* (Kunth) Nees), and four accessions of blue panic. Initial emergence and stand were rated as excellent on disked only plots. Due to droughty, loose soil conditions, high plant mortality was observed in this treatment. A September 1982 evaluation indicated that the summer planting of "SDT" blue panic exhibited the highest vigor and stand ratings of the four blue panic accessions planted. The Colorado four

o'clock accessions displayed good initial establishment but were no longer evident by the fall of 1982. The 1980 fall seeding exhibited no evidence of emergence or establishment of the seeded species.

In 1983 a total of 18 species of native and introduced grasses, forbs, and shrubs were sown on the SRER at the PMC planting site. Seedbed treatments were intermediate pits and disking. The summer 1983 planting received abundant summer precipitation that resulted in good stands for most of the grasses on both seedbed treatments. As of 1991, "SDT" and "A-130" blue panic, plains bristlegrass, cane bluestem (*Bothriochloa barbinodis* (Lag.) Herter), and yellow bluestem were still exhibiting good stand and vigor ratings.

The PMC installed July plantings in 1985 and 1986 at the SRER site. The 1985 planting consisted of 25 accessions comprised of seven introduced species and nine native species. A transplant trial using African thatchgrass (*Hyparrhenia* spp. Anderss. ex Fourn.) and saltbush (*Atriplex* spp. L.) was installed with this planting. The July 1985 planting exhibited only fair emergence with infrequent establishment of only a few accessions. It was noted that competition from Lehmann lovegrass and common buffelgrass quickly crowded out the established accessions. Rabbits grazed out the saltbush transplants, and only one African thatchgrass accession exhibited significant survival. The 1986 planting revealed no emergence or plant establishment. Low precipitation was considered the reason for this planting failure.

A 1988 planting evaluated the use of "Seco" barley as a mulch cover crop on one-half of the seeding plot and Mediterranean ricegrass (*Piptatherum coeruleum* (Desf.) P. Beauv.) on the other half of the plot. Both accessions were planted approximately 1/2 inch deep in December 1988 using a grain drill. The barley was planted at a rate of 30 pure live seed (PLS) pounds per acre and the Mediterranean ricegrass at a rate of 2 PLS pounds per acre. By the spring of 1989 only a few barley plants and no Mediterranean ricegrass plants were observed. Lack of sufficient winter precipitation and rodent predation on the barley seed was determined as the primary reasons for this failure.

The USDA Natural Resources Conservation Service, Plant Materials Program is unique among Federal programs in that it can "release" accessions that have superior qualities to commercial growers for public use. The Tucson PMC has released two species that were originally collected on the SRER. "Santa Rita" fourwing saltbush was collected by S. Clark Martin from a native stand on the SRER December 1962. The collection site was T18S, R14E, in section 3 (Tucson Plant Materials Center 1987). "Loetta" Arizona cottontop was collected from a native stand on the SRER by Larry Holzworth in October 1975. The collection site was T18S, R14E, in the southwest 1/4 of Section 3 (Tucson Plant Materials Center 2000).

Seeding Methods

In rangeland revegetation, seed is typically sown by broadcasting or by drilling. Both methods have varying degrees of effectiveness depending on condition of the seedbed and seed size. Drill seeding was initially conducted using grain drills, evolving into today's rangeland drills. Prior to the rangeland drill, scientists had to develop their

own seeding equipment. Jordan used a modified Nisbet seeder along with modified seed metering plates to plant the tiny lovegrass seeds at recommended rates (Roundy and Biedenbender 1995).

Glendening and others (1946) installed a seeding method trial in 1946 in the Middle Tank Revegetation Plot, Study Area 205, at the SRER. This trial compared the effectiveness of various seedbed treatments and seeding methods using Boer lovegrass. Treatments included two controls (no treatment); mowed, contour-furrowed, and seeded with a two-gang cultipacker with seeder attachment; mowed, contour-furrowed, cultipacked with single-gang cultipacker, and broadcast seeded; and mowed, and cultipacker-seeded only. Evaluations made in 1947 indicated a good stand of Boer lovegrass was obtained with the contour furrow and cultipacker seeder only (USDA 1947–1948). Evaluations made in 1948 indicated that established plants had died due to low precipitation in 1948. A new planting was conducted by Glendening in 1949 that used five seedbed treatments and three seeding treatments with Lehmann and Boer lovegrasses. Imposed on these treatments was a mowing treatment to control burroweed. The five seedbed and seeding treatments were (1) the Krause cutaway disc and cultipacker seeder, (2) Eccentric disc and drill, (3) interrupted furrow and drill, (4) interrupted furrow and broadcast, and (5) no seedbed preparation and broadcast seeding. Results for the 1949 planting indicated that Lehmann lovegrass had better establishment than Boer lovegrass over all treatments. This occurred in the interrupted furrow with drill seeding and interrupted furrow with broadcast seeding. The controlled burroweed plots had twice as many lovegrass plants as the uncontrolled plots.

In 1964 a field trial at the SRER was conducted to compare pelleted and nonpelleted Boer and Lehmann lovegrass seed that was broadcast onto desert rangeland following herbicide application. Pellet size was $\frac{1}{4}$ inch with an average of 10 seeds per pellet, and the pellets were aerially applied at a rate of 62 pounds per acre. On average, there were 1,400 pellets per pound (Chadwick 1964). Chadwick in 1969 summarized the results of the pelleted program. Chadwick found that only one seedling had emerged for every six pellets sown 1 month after sowing, and at the end of September no seedlings were observed, even though the site received over 10 inches of rain during July, August, and September (Chadwick and others 1969). Sowing nonpelleted seed into a prepared seedbed was more successful than broadcasting pelleted seed. Pelleted seeding failed due to lack of good seed soil contact, and the pelleting process actually reduced germination (Roundy and Biedenbender 1995).

All PMC plantings were drill seeded either using a small rangeland drill, push planter (Planet Jr.), or grain drill. Seeding rates were generally based on 20 to 25 (PLS) per ft of row for grasses and 10 PLS per ft for shrubs. Seeding depth was $\frac{1}{4}$ inch for most small-seeded species and up to $\frac{1}{2}$ inch for large-seeded species. The 1971 planting incorporated the use of barley straw for mulch. The site was drill seeded, then the mulch was applied by hand and tucked into the soil using a Soil Erosion Mulch Tiller. The mulch, as well as receiving favorable winter precipitation, provided for good emergence and stand establishment. However, when the final evaluation

was conducted in the fall of 1972, only one species, Australian saltbush (*Atriplex semibaccata* R. Br), remained alive.

Summary

The Santa Rita Experimental Range has provided an extensive outdoor laboratory for long-term rangeland revegetation trials on species adaptation, seedbed preparation methods, sowing times and rates, and unique cultural treatments such as mulching. These studies have shown promise with regard to seedbed treatments that enhance plant establishment. Much of the information gained from revegetation trials on the SRER is used in developing the USDA Natural Resource Conservation Service (Arizona) standards and specifications for the Range Planting practice (USDA 2002.)

Seedbed preparation and selection of adapted species are important factors when planning a range revegetation activity. It is evident that timing and amount of precipitation are the primary elements that ultimately determine the success or failure of a planting. Research conducted at the SRER has clearly shown that successful establishment may not indicate long-term persistence. Long-term evaluations on persistence are needed to improve and refine recommendations for range revegetation. Due to costs for brush control, future revegetation activities may leave larger areas of existing woody vegetation, creating the need for identification of shade-tolerant species that can be successfully sown under existing overstory canopies (Livingston and others 1997). Scientists have expanded research efforts to include seedbed ecology, seed germination characteristics, and range plant genetics (Smith 1998; Smith and others 2000). Recent research on the SRER has dealt with germination characteristics and seedbed ecology of Lehmann lovegrass. Results from this research have provided suggestions for managing existing Lehmann lovegrass stands and potential methods, using fire and herbicides, for re-establishing native grasses in Lehmann's dominated areas of the semidesert grassland (Abbott and Roundy 2003; Biedenbender and Roundy 1996; Livingston and others 1997). This additional information and direction can only move us closer to achieving revegetation success. It is interesting to note that early revegetation work used native plants. Unsuccessful plantings with natives led to the search and use of introduced plants such as Lehmann lovegrass. Lehmann lovegrass proved to be very successful, spreading aggressively and reducing biodiversity. Range scientists and others are again working with native plants in the semidesert grassland. This renewed interest in native plants will require research on their germination characteristics, field establishment requirements, and seed production qualities and requirements. Identification of successful establishment characteristics will help to identify native species and or their genotypes for use in revegetation. These species will be used if they are readily available in needed quantities and at an affordable price. The SRER will again provide testing sites for revegetation trials and demonstrations for livestock forage production, erosion control, and improving the biodiversity of plant communities dominated by invasive species.

References

- Abbott, L. B.; Roundy, B. A. 2003. Available water influences field germination and recruitment of seeded grasses. *Journal of Range Management*. 56: 56–63.
- Anderson, D.; Hamilton, L. P.; Reynolds, H. G.; Humphrey, R. R. 1957. Reseeding desert grassland ranges in southern Arizona. University of Arizona, Agricultural Experiment Station Bull. 249, revised.
- Biedenbender, S. H.; Roundy, B.A. 1996. Establishment of native semidesert grasses into existing stands of *Eragrostis lehmanniana* in southeastern Arizona. *Restoration Ecology*. 4: 155–162.
- Chadwick, H. W. 1964. Supplement No. 10—Santa Rita field trial—planting pelleted vs. non-pelleted seed on a mesquite area after herbicide application. FS-RM-1704. Tempe: Arizona State University. SRER Paper Archives file 137. Tucson: University of Arizona, College of Agriculture and Life Sciences.
- Chadwick, H. W.; Turner, G.T.; Springfield, H. W.; Reid, E. H. 1969. An evaluation of seeding rangeland with pellets. Res. Pap. RM-45. Fort Collins, CO: U.S. Department of Agriculture, Forest Service, Rocky Mountain Forest and Range Experiment Station. 28 p.
- Cox, J. R.; Jordan, G. L. 1983. Density and production of seeded range grasses in southeastern Arizona (1970–1982). *Journal of Range Management*. 36: 649–652.
- Frost, K. R.; Hamilton, L. P. 1964. Mechanization of range seeding. *Progressive Agriculture in Arizona*. 16(1): 4–6.
- Glendening, G. E. 1937. Artificial revegetation of depleted semidesert ranges in southern Arizona. Progress Report, RR-SW investigative program, artificial revegetation. SRER Paper Archives file 549. Tucson: University of Arizona, College of Agriculture and Life Sciences.
- Glendening, G. E.; Darrow, R. A.; Hamilton, L. P. 1946. Artificial revegetation of deteriorated semidesert grassland ranges. SRER Paper Archives file 1046. Tucson: University of Arizona, College of Agriculture and Life Sciences.
- Glendening, G. E.; Parker, K. W. 1948. Problem analysis “range revegetation in the Southwest.” RR-SW, research program, problem analyses (artificial revegetation-revegetation). Tucson: Southwestern Forest and Range Experiment Station, Tucson, Arizona. (revised May 1950 by H. G. Reynolds). SRER Paper Archives file 1649. Tucson: University of Arizona, College of Agriculture and Life Sciences.
- Jordan, G. L. 1981. Range seeding and brush management on Arizona rangelands. Tucson: University of Arizona Agricultural Experiment Station T81121.
- Livingston, M.; Roundy, B. A.; Smith, S. E. 1997. Association of overstory plant canopies and native grasses in southern Arizona. *Journal of Arid Environments*. 35: 441–449.
- Martin, S. C. 1966. The Santa Rita Experimental Range: a center for research on improvement and management of semidesert rangelands. Res. Pap. RM-22. Fort Collins, CO. U.S. Department of Agriculture, Forest Service, Rocky Mountain Forest and Range Experiment Station. 24 p.
- Martin, S. C.; Cable, D. R. 1975. Highlights of research on the Santa Rita Experimental Range. In: Arid shrublands: proceedings of the third workshop of the United States/Australia Rangelands Panel; 1973 April 5–April 26; Tucson, AZ: 51–56.
- McClaran, M. P. 1995. Desert grasslands and grasses. In: McClaran, M. P.; Van Devender, T. R., eds. *The desert grassland*. Tucson: University of Arizona Press: 1–30.
- Medina, A. L. 1996. The Santa Rita Experimental Range: annotated bibliography (1903–1988). Gen. Tech. Rep. RM-GTR-276. Fort Collins, CO: U.S. Department of Agriculture, Forest Service, Rocky Mountain Forest and Range Experiment Station. 67 p.
- Reynolds, H. G. 1951. Comparative returns from artificial and natural revegetation. Annual report, artificial revegetation. RR-SW. SRER Paper Archives file 1046. Tucson: University of Arizona, College of Agriculture and Life Sciences.
- Reynolds, H. G. 1952. Accomplishment reports, pasture 140, artificial revegetation-species mixtures. SRER Paper Archives files 58, 59, 60, & 1046. Tucson: University of Arizona, College of Agriculture and Life Sciences.
- Reynolds, H. G.; Martin, S. C. 1968. Managing grass-shrub cattle ranges in the Southwest. *Agric. Handb.* 162, revised. Fort Collins, CO. U.S. Department of Agriculture, Forest Service, Rocky Mountain Forest and Range Experiment Station. 44 p. Washington, DC: U.S. Government Printing Office.
- Roundy, B. A. 1995. Lessons from the past—Gilbert L. Jordan’s revegetation research in the Chihuahuan and Sonoran Deserts. In: Proceedings of the wildland shrub and arid land restoration symposium; 1993 October 19–21; Las Vegas, NV. Gen. Tech. Rep. INT-315. Ogden, UT: U.S. Department of Agriculture, Forest Service, Intermountain Research Station: 107–112.
- Roundy, B. A.; Biedenbender, S. H. 1995. Revegetation in the desert grassland. In: McClaran, M. P.; Van Devender, eds. *The desert grassland*. Tucson: University of Arizona Press: 265–303.
- Roundy, B. A.; Winkel, V. K.; Cox, J. R.; Dabrenz, A. K.; Tewolde, H. 1993. Sowing depth and soil water effects on seedling emergence and root morphology of three warm-season grasses. *Agronomy Journal*. 85: 975–982.
- Slayback, R. D.; Cable, D. R. 1970. Larger pits aid revegetation of semidesert rangeland. *Journal of Range Management*. 23: 333–335.
- Slayback, R. D.; Renney, C. W. 1972. Intermediate pits reduce gamble in range seeding in the Southwest. *Journal of Range Management*. 25: 224–227.
- Smith, S. E. 1998. Variation in response to defoliation between populations of *Bouteloua curtipendula* var. *caespitosa* (Poaceae) with different livestock grazing histories. *American Journal of Botany*. 85: 1266–1272.
- Smith, S. E.; Riley, E.; Tiss, J. L.; Fendenheim, D. M. 2000. Geographical variation in predictive seedling emergence in a perennial desert grass. *Journal of Ecology*. 88: 139–149.
- Tucson Plant Materials Center. 1987. Notice of release: Santa Rita fourwing saltbush (*Atriplex canescens*). USDA-NRCS Tucson Plant Materials Center, Tucson, AZ. May 1987. 17 p.
- Tucson Plant Materials Center. 2002. Notice of release: Loetta Arizona cottontop (*Digitaria californica*). USDA-NRCS Tucson Plant Materials Center, Tucson, AZ. May 2000. 8 p.
- U.S. Department of Agriculture, Natural Resources Conservation Service. Arizona 2002. Field office technical guide, Section IV—practice standards and specifications, range planting. Phoenix, AZ: Natural Resources Conservation Service.
- U.S. Department of Agriculture, Soil Conservation Service. 1947–1948. Technical Report of the Tucson Plant Materials Center, 1947–1948. Tucson, AZ: Tucson Plant Materials Center.
- U.S. Department of Agriculture, Soil Conservation Service. 1988. Technical Report of the Tucson Plant Materials Center, 1988. Tucson, AZ: Tucson Plant Materials Center.
- Winkel, V. K.; Roundy, B. A. 1991. Effects of cattle trampling and mechanical seedbed preparation on grass seedling emergence. *Journal of Range Management*. 44: 176–180.
- Winkel, V. K.; Roundy, B. A.; Blough, D. K. 1991. Effects of seedbed preparation and cattle trampling on burial of grass seeds. *Journal of Range Management*. 44: 171–175.

Hydrology and Soil Erosion

Abstract: We review research on surface water hydrology and soil erosion at the Santa Rita Experimental Range (SRER). Almost all of the research was associated with eight small experimental watersheds established from 1974 to 1975 and operated until the present. Analysis of climatic features of the SRER supports extending research findings from the SRER to broad areas of the Southwest with similar climates. Conceptual models for annual water balance and annual sediment yield at the SRER were developed and supported by data from four very small experimental watersheds. The impacts of rotation and yearlong grazing activities, and of mesquite removal were analyzed using data from four small experimental watersheds. The analyses suggested that mesquite removal reduced runoff and sediment yield, but differences in hydrologic response from paired watersheds due to soil differences dominated grazing and vegetation management impacts. The 28 years of monitoring under the same experimental design on the four pairs of watersheds provides us with a long period of “pretreatment” data on the paired watersheds. New treatments could now be adapted and designed based on lessons learned from monitoring over nearly three decades. There is a unique opportunity to institute long-term adaptive management experiments on these experimental watersheds.

Keywords: water balance, runoff, sediment yield, watersheds

Acknowledgments: We gratefully acknowledge the dedicated technicians and scientists from the U.S. Department of Agriculture’s Forest Service and Agricultural Research Service, and the University of Arizona, College of Agriculture, who have steadfastly operated and maintained the Santa Rita raingage network, and the land use and management metadata, conducted vegetation and soil surveys and monitoring, and installed and maintained the eight experimental watersheds used for the research described in this paper. Without their efforts, there would be no studies of hydrology and soil erosion on the Santa Rita Experimental Range. We also appreciate the reviewers’ timely and helpful comments and suggestions that significantly improved the paper. We thank all of you.

Introduction

Background

Soil, water, air, the plants and animals they support, and human interaction with them are a central focus of natural resources research and management. In this paper we focus on hydrology (specifically surface water hydrology) and soil erosion (specifically soil erosion and sediment transport by water). The Santa Rita Experimental Range (the SRER or simply the Range hereafter) was established in 1903 (see, for example, Medina 1996). Since the end of World War II, several landmark programs have contributed to our current understanding of hydrology in desert (arid) and semidesert (semiarid) ecosystems. Notable examples include the following.

At the third General Conference of UNESCO held in Beirut in 1948, an International Institute of Arid Zone was proposed. In December of 1949 an International Council was approved, and it met in November, 1950. This effort led to the preparation of a series of reports on arid regions of the earth. In 1951 the Southwestern and Rocky Mountain Division of the AAAS

Leonard J. Lane is a Research Hydrologist (retired) with the USDA Agricultural Research Service, Southwest Watershed Research Center in Tucson, AZ. He completed a B.S. degree (honors) in engineering mathematics and an M.S. degree in systems engineering at the University of Arizona, and a Ph.D. degree in civil engineering (hydrology and water resources) at Colorado State University. Mary R. Kidwell is an Ecologist with the USDA Agricultural Research Service, Southwest Watershed Research Center in Tucson, AZ. She received a B.A. degree in economics and organizational behavior and management from Brown University and an M.S. degree in renewable natural resource studies from the University of Arizona.

In: McClaran, Mitchel P.; Ffolliott, Peter F.; Edminster, Carleton B., tech. coords. Santa Rita Experimental Range: 100 years (1903 to 2003) of accomplishments and contributions; conference proceedings; 2003 October 30–November 1; Tucson, AZ. Proc. RMRS-P-30. Ogden, UT: U.S. Department of Agriculture, Forest Service, Rocky Mountain Research Station.

established the Committee on Desert and Arid Zones Research to assist "study of the factors affecting human occupancy of semiarid and arid regions." This Committee was very active and productive for over two decades in a variety of natural and social science areas.

In 1953 the U.S. Department of Agriculture established the 150-km² Walnut Gulch Experimental Watershed near Tombstone, AZ. Research from this experimental watershed established an infrastructure and the scientific understanding and apparatus enabling measurement of surface runoff, soil erosion, and sediment yield from small rangeland watersheds. This nearby infrastructure and understanding led to the establishment of eight small experimental watersheds on the SRER in 1974 and 1975.

From 1967 to 1974 the United States participated in the International Biological Program. The National Science Foundation funded and supported the Desert Biome Program throughout the West from 1972 through 1977. Beginning in 1971 and continuing to the present the Arizona Section of the American Water Resources Association and the Hydrology Section of the Arizona-Nevada Academy of Science has published "Hydrology and Water Resources in Arizona and the Southwest." In 1978, Academic Press, Inc., London, started publishing the "Journal of Arid Environments" as a forum for multidisciplinary and interdisciplinary dialogue on problems in the world's deserts.

Purpose

Although these programs and projects have immeasurably increased our knowledge and understanding of hydrology of deserts areas, none has produced a focused and in-depth synthesis of surface water hydrology and soil erosion in arid and semiarid areas, and especially, on the SRER. Therefore, we propose to partially fill this gap with this paper. Toward this end, the paper focuses on surface water hydrology and soil erosion by water. Emphasis is on hydrology and erosion occurring on the SRER, but regional data and research findings are used for background information and as comparative studies to contrast and broaden similar findings on the SRER.

Scope and Limitations

Our review and analyses are focused on measurements and modeling of surface water hydrology, upland soil erosion by water, and yield of water and sediment from very small experimental watersheds. While major emphasis is on measured data and what we can learn from them, interpretation and understanding of the measured data require understanding and application of conceptual models of the dominant physical processes, and mathematical models (computer simulation models or simply simulation models) describing those processes. The inclusion of conceptual and simulation models is necessary to interpret the measured data, to add a dimension of predictability, and to help understand the processes across a continuum of space and time when measurements are limited to points in space over short time periods.

Review of Hydrologic and Soil Erosion Research at Santa Rita

Overview

Research has been conducted on the 21,500-ha SRER since 1903. The goal of research at the SRER is to investigate and understand the ecology and management of semiarid rangelands. The U.S. Department of Agriculture Bureau of Plant Industry operated the SRER from 1903 until 1915, and from 1915 until 1988 the U.S. Department of Agriculture Forest Service assumed responsibility. Since 1988 the SRER has been under the administration of the Arizona State Land Department and is managed by the University of Arizona for the purpose of conducting ecological and rangeland research (McClaran and others 2002).

According to Martin and Reynolds (1973), the SRER is representative of over 8 million hectares of semiarid (semi-desert) grass-shrub ecosystems in southern Arizona, New Mexico, Texas, and northern Mexico. The extent to which research findings from the SRER are transferable over these broad geographical areas depends, in large part, upon how widespread climatic characteristics of the SRER are represented regionally.

Climate

Although the focus herein is hydrology and soil erosion, climate plays such a strong role that a brief climatic summary of the SRER is necessary. Green and Martin (1967) analyzed precipitation data from the Range. A common 26-year period, 1940 to 1965, for 22 raingages situated across the SRER was used for statistical analyses. Average annual precipitation for this period of record varied from about 282 mm at the northwest gage at an elevation of approximately 914 m MSL to 492 mm at an elevation of approximately 1,310 m. This range of $492 - 282 = 210$ mm over an elevation difference of only $1,310 - 914 = 396$ m indicates a strong trend of about 53 mm of precipitation per 100 m difference in elevation. These two raingages are located about 17.4 km apart so that the rate of change in mean annual precipitation is $210 \text{ mm per } 17.4 \text{ km} = 12 \text{ mm per km}$ of distance.

These statistics of 53 mm of mean annual precipitation change per 100 m of elevation change and 12 mm of mean annual precipitation change per km horizontal distance indicate a strong orographic effect in precipitation. The dry adiabatic lapse rate is about 9.8 °C per km of elevation so that mean annual temperature also varies with elevation. Taken together, the changes in mean annual precipitation and temperature with elevation mean that the Headquarters (Florida location or Santa Rita Experimental Range station) climate does not represent the average conditions over the 21,500 ha SRER. Rather, the Florida station represents an extreme in terms of high precipitation and cooler temperature. In fact, following Trewartha and Horn (1980), the Florida station is near the boundary between semiarid and subhumid climates, and the Northwest station is near the boundary between semiarid and arid climates. The average climate for the SRER is classified as semiarid or steppe.

Annual Water Balance

The term "hydrologic cycle" is the most general way of describing the cycling or movement of water through the lands, oceans, and atmosphere. The hydrologic cycle is usually described and quantified in terms of its components. These components include precipitation, evaporation, transpiration, runoff, ground water, and water temporarily stored such as in soil moisture, lakes, and reservoirs. The term "water balance" as used in hydrologic studies has a similar meaning to the term "hydrologic cycle," but it connotes a budgeting or balancing of components in the hydrologic cycle for a given place or area. In this paper, the area we use to make water balance calculations is the watershed.

A watershed is described with respect to surface runoff as being defined by a watershed perimeter (for example, see Lane and others 1997). This watershed perimeter is the locus of points where surface runoff produced inside the perimeter will flow to the watershed outlet. Therefore, water balance calculations are for a watershed and a specific time period such as annual, seasonal, daily, or hourly. Our emphasis herein is on an annual water balance and on storm event or daily values of water balance used to compute an annual balance on small watersheds in upland areas.

Conceptual Model for Annual Water Balance—In warm to hot semiarid regions with bimodal annual precipitation, such as the SRER, a conceptual model of an annual water balance can be described as follows. Precipitation varies seasonally with the most prominent period of precipitation in the summer (July to September), with a secondary peak in the winter (late December to March), and with relatively dry periods in the spring and fall. Mean annual precipitation varies between about 250 and 500 mm. Mean annual surface runoff from small upland watersheds (defined herein as small areas ranging in size from a few square meters up to a few hectares) varies from near zero up to about 10 percent of annual precipitation or from near zero to 50 mm. Actual mean annual evapotranspiration (the sum of the actual amount of evaporation from soil and cover material and the actual amount of plant transpiration) ranges from about 90 to near 100 percent of mean annual precipitation. During extremely high precipitation episodes (for example, heavy summer or fall rainfall from the influx of moisture from tropical storms and hurricanes and very wet winters when the winter storm track is over southern Arizona), soil moisture can increase to field capacity (the upper limit of soil moisture storage when percolation through the soil profile begins) and deep percolation of soil moisture below the plant rooting depth can occur (see for example, Lane and others 1984; Renard and others 1993). These periods of high soil moisture and deep percolation are relatively rare so that mean annual values derived from them are highly variable and highly uncertain.

The conceptual model is that there is little and very rare percolation below the root zone so that most soil moisture remains in the upper meter or so of the soil, surface runoff is due to rainfall rates exceeding the infiltration capacity of the soil, actual annual evapotranspiration is nearly equal to annual precipitation (minus infrequent surface runoff and very rare deep percolation), and that soil moisture storage is

recharged and depleted on an annual basis so that the mean annual change in soil moisture is near zero.

Empirical evidence of the applicability of this conceptual model for an annual water balance at the SRER includes the general absence of (1) perennial and intermittent streams, (2) springs and seeps, and (3) shallow ground water. Exceptions to ephemeral streams may occur when perennial streams originating in the mountains flow onto the SRER. However, the conceptual model is for small upland areas on the SRER and is generally supported by observations and measurements (see Lawrence 1996, as discussed later).

Mathematical Model for Annual Water Balance—A mathematical model of annual water balance for upland watersheds, such as those on the SRER, can be written as follows. The one-dimensional water balance equation for a unit area, to plant rooting depth, ignoring runoff (runoff originating out of the unit area and flowing onto it) and assuming subsurface lateral flow is zero, can be written as

$$dS/dt = P - Q - AET - L \quad (1)$$

where dS/dt is the change in soil moisture (mm), P is precipitation (mm), Q is runoff (mm), AET is actual evapotranspiration (mm), L is percolation or leaching below the rooting depth (mm), and t is time (years for an annual water balance although the actual calculations may be made using a daily time step).

Example Water Balance Calculations Using a Simple Model—We selected a simple water balance model that could be operated based on limited available climatic, soils, vegetation, and land use data. The CREAMS Model (Knisel 1980) solves equation 1 for a daily time step and then sums the results for monthly and annual values. The CREAMS Model has previously been applied at arid and semiarid sites somewhat similar to the SRER, including the Walnut Gulch Experimental Watershed near Tombstone, AZ (see Renard and others 1993 and Goodrich and others 1997 for details on modeling and descriptions of Walnut Gulch).

The CREAMS Model was applied to Watershed Lucky Hills 3, a small semiarid watershed on the Walnut Gulch Experimental Watershed. Rainfall and runoff data were available for 17 years (1965 to 1981), and were used to optimize the model parameters for runoff simulation. As P and Q were measured, the model was calibrated to match observed values of runoff, Q , and then AET and L were estimated using a form of equation 1. These calculations are summarized in table 1. In table 1, column 1 lists the month or the annual period, column 2 lists measured precipitation in mm, column 3 lists measured surface runoff in mm, column 4 lists the estimated actual evapotranspiration in mm, column 5 lists estimated percolation below the plant rooting depth in mm, and column 6 lists the estimated average plant available soil moisture in mm. Notice that the annual values in Columns 2 to 5 are annual summations, whereas the annual value for plant available soil water is an average annual value. Values of Q , AET , and L in table 1 do not exactly sum to P because dS/dt was not exactly equal to zero over the simulation period. However, dS/dt was relatively small, about 1.4 mm in the entire soil profile for the data shown in table 1.

Table 1—Average annual water balance for Watershed 63.103 at Walnut Gulch, Arizona, as calculated with the CREAMS Model calibrated using 17 years of rainfall and runoff data, 1965 to 1981 (adapted from Renard and others 1993).

Month	Precipitation	Runoff	AET	Percolation	Plant available soil water
1	2	3	4	5	6
----- mm -----					
January	18.0	0.58	18.6	0.03	22.2
February	14.2	.28	18.0	.17	2.7
March	15.0	.18	21.2	.0	16.1
April	3.8	.0	11.8	.0	6.6
May	5.3	.13	7.4	.0	2.0
June	8.3	.28	8.4	.0	1.3
July	87.9	7.24	62.2	.0	9.8
August	63.3	4.78	63.7	.0	14.9
September	39.1	3.45	34.8	.0	15.7
October	21.0	1.70	16.5	.0	16.0
November	7.7	.05	9.7	.0	16.0
December	19.3	1.02	12.1	.0	18.8
Annual	302.9	19.7	284.4	.20	11.8

The mean monthly precipitation distribution at Walnut Gulch is bimodal (table 1) with a strong summer peak from July through September and a small secondary peak from December through March. Soil moisture storage (plant available soil water) follows this trend with recharge occurring July through October and again in December and January. Rapid soil moisture depletion occurs from February through June (table 1, last column).

Annual Water Balance for Small Watersheds on the Santa Rita—In cooperation with the USDA Forest Service and the University of Arizona, the USDA Agricultural Research Service established and instrumented eight small experimental watersheds during 1974 to 1975 within the Santa Rita Experimental Range. These experimental watersheds were established to study the impact of cattle grazing and vegetation manipulation methods on hydrology and soil erosion. Four of the watersheds (WS1 to WS4) were located at an approximate elevation of 976 to 1,040 m, while the other four watersheds (WS5 to WS8) were located at a higher elevation of about 1,170 m. The four upper watersheds are emphasized in this paper and their locations are shown in figure 1.

These watersheds enable scientists to study the effects of livestock grazing and vegetation management practices on runoff and sediment yield in the semiarid regions of the Southwestern United States (Martin and Morton 1993). In 1974, two of the watersheds (WS6 and WS7) were treated with basal applications of diesel oil to control the invasion of mesquite (*Prosopis velutina*–Woot.), and were subsequently retreated as needed. Watersheds 5 and 8 remained untreated. Grazing practices include yearlong grazing on two watersheds (WS7 and WS8) and a rotation system on the other 2 (WS5 and WS6). Treatment and management have remained constant since the study's inception. The watersheds are instrumented to measure precipitation rate and depth, surface runoff, and sediment yield (Lawrence 1996). Channel cross-sections, using the method described by Osborn and Simanton (1989), and vegetation characteristics (Martin and

Morton 1993) have been measured periodically. Although this is a brief description, more information on the SRER can be found in Medina (1996) and McClaran and others (2002).

Lawrence (1996) used measured data and experts' judgment in a multiobjective decision support system to evaluate management systems on the upper four small watersheds described above. Available precipitation and runoff data from these watersheds were compiled for a 16-year period, 1976 to 1994 (Lawrence 1996). Therefore, an annual water balance could be constructed by estimating actual evapotranspiration and percolation below the root zone. These estimates are summarized in table 2. The drainage area for each watershed and its generalized soil texture are shown in column 1 of table 2. The mean annual values of actual evapotranspiration (AET) (column 5) and percolation below the rooting depth (L) (column 6) were estimated based on the water balance equation (equation 1) and the CREAMS water

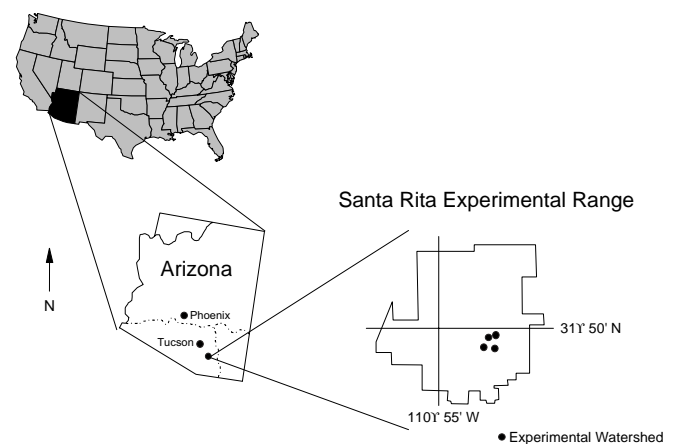

Figure 1—The Santa Rita Experimental Range showing the location of the upper four experimental watersheds.

Table 2—Summary of estimated annual water balance on the upper four experimental watersheds at the Santa Rita Experimental Range from 1976 to 1991. Precipitation is for a centrally located raingage on Watershed 5. All values are annual means in mm and values in parentheses are coefficients of variation, in percent, for the measured variables.

Watershed 1	Treatment 2	Measured precipitation 3	Measured runoff 4	Estimated AET 5	Estimated percolation 6
WS5 (4.02 ha) sandy loam	Rotation grazing, mesquite retained	440.0 (27.0)	16.7 (102.0)	423.0	0 to 1
WS6 (3.08 ha) loamy sand	Rotation grazing, mesquite removed	440.0 (27.0)	1.6 (138.0)	438.0	0 to 1+
WS7 (1.06 ha) sandy loam	Continuous grazing, mesquite removed	440.0 (27.0)	25.2 (123.0)	415.0	0 to 1
WS8 (1.12 ha) sandy loam	Continuous grazing, mesquite retained	440.0 (27.0)	30.1 (92.0)	410.0	0 to 1

balance model (described earlier as applied at the Walnut Gulch Experimental Watershed). The coefficient of variation (CV), defined as the standard deviation of the annual values divided by their mean, was about 27 percent for measured mean annual precipitation and between about 90 and 140 percent for measured mean annual runoff. Values of AET, and especially L, are extremely uncertain as they contain the natural variability of the measured data as well as all the errors and uncertainty due to modeling. Therefore, we did not show estimate CVs for AET and L.

Lawrence (1996) interpreted the data summarized in table 2 as follows. Watersheds with mesquite removed appeared to produce less runoff than their paired watershed with mesquite retained (runoff from WS6 < WS5 and runoff from WS7 < WS8). The observed reductions in runoff from mesquite removal for both grazing systems are consistent with the findings from experiments reported in the literature (for example, Carlson and others 1990).

However, Watersheds 5, 7, and 8 have sandy loam soils, while Watershed 6 has loamy sand soils. Runoff differences due to differences in soils (WS6 versus WS5) were more significant than the differences due to grazing system and mesquite removal. The technique of using paired watersheds and treating one of each pair is based on the assumption that the paired watersheds have similar hydrologic behavior. This is not the case for Watersheds 5 and 6 where different soils (sandy loam versus loamy sand) result in different hydrologic response to precipitation events. One way to determine if the watersheds are similar in response is to instrument and monitor them for a sufficient period of time before the treatments are imposed. Unfortunately, this was not done on the four pairs of watersheds on the SRER, rather, treatments were imposed at the same time that hydrologic monitoring was initiated.

Finally, the computed annual water balance for the upper four experimental watersheds at the SRER agrees quite well with the previously described conceptual model for water balance on small semiarid watersheds. Although mean annual runoff was relatively small (0.37 percent of mean annual precipitation on WS6 to 6.84 percent of mean annual precipitation on WS8), this does not mean that runoff is not an important part of the water balance. Runoff amounts, although small when compared with precipitation, are responsible for flooding, soil erosion, sediment transport and yield, and significant landscape evolution over time.

Surface Water Hydrology

Although measuring or modeling an annual water balance involves measuring or modeling individual rainfall-runoff events, and thus surface water hydrology for individual storm events, there are other studies at SRER providing additional insight into the dynamics of rainfall-infiltration-runoff during individual storm events. It should be noted that the number of such studies on SRER are small compared with more comprehensive watershed studies in the region (such as Walnut Gulch in southeast Arizona and the lower watershed studies on Beaver Creek in north-central Arizona). Therefore, quantitative determination of hydrologic processes during individual runoff events is somewhat lacking and almost entirely based on the eight experimental watersheds established on SRER.

Diskin and Lane (1976) studied the applicability of unit hydrograph concepts at SRER. Unit hydrographs provide a means of computing runoff hydrographs from a small watershed given rainfall and infiltration data. They analyzed a number of rainfall and runoff events on one of the lower small watersheds (Watershed 1). Double triangle unit hydrographs were fitted to individual storm events. The differences in the shapes of individual unit hydrographs were found to be small so that they could be approximated by a single double-triangle-unit hydrograph.

Significant errors in estimating surface runoff and erosion rates are possible if a watershed is assumed to contribute runoff uniformly over the entire area, when actually only a portion of the entire area may be contributing. Generation of overland flow on portions of small semiarid watersheds was analyzed by three methods: (1) an average loss rate procedure, (2) a lumped-linear model, and (3) a distributed-nonlinear model. These methods suggested that, on the average, 45, 60, and 50 percent, respectively, of the drainage area was contributing runoff at the watershed outlet. Infiltrometer data support the partial area concept and indicate that the low infiltration zones are the runoff source areas as simulated with a distributed and nonlinear kinematic cascade model (Lane and others 1978a). A subsequent herbicide tracer study was conducted to provide empirical data to test the partial area concept at SRER.

Based on the concept of partial area response, Lane and others (1978b) conducted a runoff tracer study on two small watersheds (Watersheds 1 and 2). The watersheds were partitioned into four geomorphic subzones or hydrologic response units. Each of the four zones on both watersheds

was treated with about 1 kg per ha of an individual water-soluble herbicide. Runoff volumes and sources estimated using the tracers were consistent with results from simulation studies and thus supported the partial-area concept of surface runoff generation at SRER.

The cited studies of surface water hydrology at SRER provided additional insight into rainfall-runoff processes, how they are nonuniform over even small watersheds (partial-area response), that unit hydrograph and kinematic routing methods can be used to develop runoff hydrographs from small watersheds at SRER, and that concepts of overland flow and ephemeral streamflow in alluvial stream channels are applicable at SRER. That these findings are consistent with findings at Walnut Gulch and at other semiarid watersheds suggests that research findings from small watersheds at SRER have broader regional applicability and significance.

Soil Erosion and Sediment Transport

Observations and measurements of water erosion at the SRER suggest that soil erosion by water dominates over wind erosion. However there are no long-term studies of wind erosion comparable to the long-term runoff and water erosion studies on the eight small watersheds. Nonetheless, we describe a conceptual model for soil erosion, sediment transport, and sediment yield for small semiarid watersheds based on water erosion and neglecting wind erosion.

A Conceptual Model for Soil Erosion, Sediment Transport, and Sediment Yield—Schumm (1977) presented a description of an idealized fluvial system (a conceptual model) as consisting of three zones of sediment source, transport, and sink. Zone 1 was described as the drainage basin as a source of runoff and sediment, Zone 2 as the main river channels as the transfer component, and Zone 3 as the alluvial channels, fans, and deltas, as sinks or zones of deposition. This conceptual model of Zone 1 as a sediment source, Zone 2 as the sediment transport component, and Zone 3 as a sediment sink has proven useful in generalizing processes at the mid to large watershed scale (such as rivers as large as the Missouri-Mississippi system).

Watersheds contain interior or subwatersheds, and there often exists a similarity of shape and structure across the range of scales from the watershed to its smaller sub-watersheds. Building on this similarity concept and the three-zones concept, we can define the basis for a conceptual model of soil erosion and sediment yield. The basis is that there is a continuum of "sediment source-transport-and sink zones" across a range of scales from the watershed down to its smallest components.

The conceptual model we propose is that within a semiarid watershed there is a continuum of sediment source-transport-sink zones and that different erosional processes are dominant at different spatial scales. Further, at the plot to hillslope to very small watershed scale (about a square meter up to perhaps a few hectares) hillslope topography, vegetative canopy cover, surface ground cover, soil and soil detachment processes are dominant. At the subwatershed scale (that is, one to perhaps a thousand hectares) geology, soils, gully and channel processes, vegetation type, and sediment transport and deposition processes are dominant.

Although beyond the scope of this paper, at the watershed scale (from about a thousand to greater than 10,000 ha) partial rainfall coverage of the watershed, infiltration of streamflow (transmission losses) to the channel bed and banks, sediment transport capacities, geology, and soils are dominant. Of course, all processes are important within a watershed, but we are describing dominance as a function of watershed scale. In summary, soil erosion, sediment transport and deposition, and thus sediment yield vary as a function of spatial scale with identifiable factors and processes dominating them depending upon spatial scale (table 3).

Hillslope Erosion and Sediment Yield From Very Small Watersheds—At the plot, hillslope scale, and very small watershed scale (from a square meter up to a few hectares appropriate for the experimental watersheds at the SRER) overland flow processes dominate on hillslopes, as channelization at this scale is at the microtopographic level and larger channels are usually absent. At the small watershed scale, hillslope processes are important, but flow becomes channelized, and processes of sediment transport and deposition are also important in determining watershed sediment yield. This is the spatial scale appropriate for the eight experimental watersheds on the SRER. The sediment source-transport-sink concept applies at this scale and is observable in the field. At the scale of a meter or less, one can see debris dams caused by accumulation of litter behind a plant, rock, or other small feature, and that these debris dams induce sediment deposition and thus trap sediment. At the hillslope scale, one can see areas of no apparent soil erosion (unless closely observed with a trained eye), areas of rill or concentrated flow erosion, and areas of sediment deposition such as at the toe of a slope. Hillslopes contribute water and sediment to small ephemeral channels that drain to the watershed outlet, and in these channels one can observe areas of scour or degradation, areas in which no scour or deposition is apparent, and areas of sediment deposition. Sediment passing the watershed outlet (in the case of the SRER watersheds, the runoff measuring flumes) is called sediment yield. It is customary to speak in terms of sediment mass flux per unit time or sediment mass flux per unit time per unit area (for example t/ha/y).

As part of his analyses, Lawrence (1996) tabulated annual runoff and sediment yield data measured at the outlets of the upper four SRER watersheds for the 16-year period 1976 to 1991. The main channel in each watershed was designated as the channel from the watershed outlet along its course to its termination in the upper areas of the watershed.

Mean annual sediment yield (along with mean annual precipitation and runoff for completeness) are summarized in table 4. The annual means vary from under 0.1 t per ha from Watershed 6 to over 4 t per ha from Watershed 5. Also shown in column 5 of table 4 is the mean annual sediment concentration, C_b , in percent by weight. Values of mean sediment concentration varied from a low of 0.38 percent (3,800 mg per L) from Watershed 6 to a high of 2.5 percent (25,000 mg per L) from Watershed 5. As was the case for mean annual runoff, the very low sediment yield from Watershed 6 is more the result of its different soil (loamy sand on WS6 and sandy loam on WS5, WS7, and WS8) than as a result of the treatments. Watershed 6 produced significantly less runoff and correspondingly significantly less

Table 3—Summary of dominant processes controlling sediment yield from semiarid watersheds such as those at Walnut Gulch and the SRER. Table adapted from Lane and others 1997 to illustrate a conceptual model for soil erosion and sediment yield on semiarid watersheds.

Approximate scale (ha) on the sediment source transport sink continuum		
Plot to hillslope (10 ⁻⁴ to 10 ⁰ ha)	Subwatershed (10 ⁰ to 10 ³ ha)	Watershed (10 ³ to 10 ⁴ ha)
← Dominant processes at the indicated scale →		
← Range of scales studied at the SRER →		
Topography, vegetative canopy cover, surface ground cover, soil, and soil detachment	Geologic parent material-soils, gully and channel processes, vegetation type, sediment transport and deposition	Partial rainfall coverage, transmission losses, channel processes, sediment transport capacities, and soils
← Processes more or less in common across scales →		
Rainfall, runoff amounts, and Intensities		
Spatial variability and interactions		

sediment yield than the other three watersheds. Again, there is a suggestion in the data that removing mesquite reduces runoff and sediment yield, but differences in the soils dominated the impacts of grazing and mesquite removal on runoff and sediment yield. Given the high variability in sediment yield (CVs of mean annual sediment yield in table 4 range from 83 to 107 percent), it is instructive to examine the role of extreme years (years with annual sediment yield significantly larger than the mean) in determining mean annual sediment yield.

Erosion and sediment yield monitoring programs are often conducted over short time periods, and the resulting short-term databases are used for a variety of purposes including estimation of mean annual soil erosion rates, mean annual sediment yield, and the resulting rates of landscape evolution. Since by definition large events are rare, a short monitoring period may or may not sample any large events. Annual sediment yields for each of the 16 years from 1976 through 1991 were computed, and from them a

mean annual sediment yield for all 16 years was computed for each of the small watersheds. Contributions of sediment yield from the individual years (not events) were used to analyze the relationship between sediment yield in “large sediment yield years” and the 16-year mean annual sediment yield. The relation between sediment yield in the years with the largest annual sediment yields to the 16-year mean annual sediment yield from the four upper watersheds on the SRER is illustrated in figure 2.

We interpret the data shown in figure 2 as follows. During 16 years of measurements, the year with the largest sediment yield (fraction of years = 1/16 = 0.0625) accounted for about 18 to 26 percent of the mean annual sediment yield. The four years with the largest sediment yield (25 percent of the period of record of 16 years) accounted for about 54 to 66 percent of the mean, and the 8 years with the largest sediment yields accounted for about 80 to 90 percent of the mean annual sediment yields on the four watersheds. Similar statistics and

Table 4—Summary of mean annual sediment yield from the upper four experimental watersheds at the Santa Rita Experimental Range from 1976 to 1991. Precipitation is for a centrally located raingage on Watershed 5. The values are annual means in mm for precipitation and runoff and in t per ha for sediment yield. The values in parentheses are coefficients of variation, in percent, for the measured variables.

Watershed 1	Treatment 2	Measured precipitation 3	Measured runoff 4	Measured sediment yield 5
WS5 (4.02 ha) sandy loam	Rotation grazing, mesquite retained	440.0 (27.0)	16.7 (102.0)	4.21 (94.0) (C _b = 2.5 percent) ^a
WS6 (3.08 ha) loamy sand	Rotation grazing, mesquite removed	440.0 (27.0)	1.6 (138.0)	0.06 (107.0) (C _b = 0.38 percent)
WS7 (1.06 ha) sandy loam	Continuous grazing, mesquite removed	440.0 (27.0)	25.2 (123.0)	1.48 (106.0) (C _b = 0.59 percent)
WS8 (1.12 ha) sandy loam	Continuous grazing, mesquite retained	440.0 (27.0)	30.1 (92.0)	3.67 (83.0) (C _b = 1.2 percent)

^a C_b = Mean sediment concentration in percent by weight. Note: 1-percent sediment concentration = 10,000 mg per L.

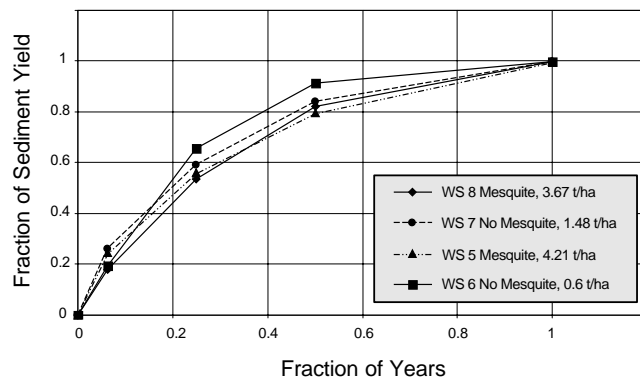

Figure 2—Relation between sediment yield in the years with the largest annual sediment yields to the 16-year mean annual sediment yield on four watersheds at the Santa Rita Experimental Range in southern Arizona.

graphs could be computed for annual runoff, and they would show similar results.

The significance of these results is clear. Runoff and sediment yield estimates from short periods of record on semiarid watersheds (such as those at SRER) are highly variable (CVs of mean annual runoff and mean annual sediment yield are on the order of 100 percent or more), and thus there is a great deal of uncertainty in the means estimated from short periods of record. For data such as these in tables 2 and 4, the natural high levels of variability and the resulting high levels of uncertainty make it very difficult to evaluate the impacts of land use and management (in this case, alternative grazing systems and mesquite removal) on runoff and sediment yield. In the face of such high natural variability in time, relatively longer periods of record (at least greater than 16 years) are needed to evaluate the impacts of land use and management practices. In addition, the technique of using paired watersheds and treating one of each pair loses much of its power if the watersheds are significantly different in their rainfall-runoff and runoff-sediment yield relationships before imposition of treatments or alternative land management practices. This argues eloquently for pretreatment monitoring and modeling to ensure that the paired watersheds are as similar as is possible in their hydrologic and erosional characteristics.

Discussion

Summary

We reviewed hydrologic and soil erosion research on the SRER. Almost all of that research was associated with the eight small experimental watersheds established in 1974 to 1975 and operated until the present. Analysis of climatic features of the SRER supports the concept of extending research findings from the SRER to broad areas of the Southwest with similar climatic regimes.

Conceptual models for annual water balance and annual sediment yield at the SRER were developed. Analyses and

interpretation of measured and modeled hydrologic data on water balance, soil erosion, and sediment yield from four small experimental watersheds supported these conceptual models and added specificity to their general scientific content.

Due to its long history and rich databases of vegetation characterization, grazing, and land management activities, the SRER is well suited for evaluating the impacts of land use and management practices upon hydrology, soil erosion processes, and watershed sediment yield. The impacts of cattle rotation and yearlong grazing activities and mesquite removal were analyzed using data from four small experimental watersheds. The analyses suggested that mesquite removal reduced runoff and sediment yield, but differences in hydrologic response from paired watersheds due to soil differences dominated grazing and vegetation management impacts.

High levels of variability in components of the water balance and in sediment yield suggest that long duration watershed studies are required to quantify components of the water balance and sediment yield.

Some Lessons Learned

- Climatic features of the SRER are similar to broad areas of the American Southwest and Northern Mexico so that research findings from hydrologic and erosion studies on the SRER have broad geographical applicability.
- Hydrograph development techniques such as unit hydrographs and kinematic cascade models can be successfully applied on the SRER.
- Variations in topography, soils, and vegetative cover within very small watersheds on the SRER result in what is called a partial area response where only portions of a watershed may be producing surface runoff. These simulation modeling results were verified by herbicide tracer studies.
- A conceptual model of annual water balance developed for semiarid watersheds is applicable on the SRER.
- A conceptual model for annual sediment yield from semiarid watersheds is applicable on the SRER.
- Paired watershed studies were used to study the impacts of grazing systems and mesquite removal on runoff and sediment yield, but the results were ambiguous because of significant differences in hydrological responses resulting from variations in soil properties between the paired watersheds (WS5 and WS6).
- Paired watershed studies should include a period of pretreatment monitoring and modeling before treatments are imposed to determine if the paired watersheds are indeed hydrologically similar.
- Extreme natural variability in components of the water balance and sediment yield from very small watersheds suggest that long periods of observation and monitoring are required to evaluate impacts of land use and management practices on runoff, erosion, and sediment yield.

Path Forward for Hydrology and Soil Erosion Research at Santa Rita

Twenty-eight years of hydrologic data and observations are now available for the eight paired experimental watersheds at SRER. Treatments (yearlong versus continuous

grazing, and mesquite removal versus mesquite retained) have been maintained over this entire period of record. This presents us with unique and invaluable opportunities.

If new treatments were imposed now, these 28 years of monitoring under the same experimental design on the four pairs of watersheds would provide a long period of "pretreatment" monitoring on the paired watersheds (WS1 versus WS2, WS3 versus WS4, WS5 versus WS6, and WS7 versus WS8). New treatments could now be adapted and designed based on lessons learned from monitoring and modeling activities over nearly three decades. There is a unique opportunity to institute long-term adaptive management experiments on these eight experimental watersheds. Institutional control of the watersheds, scientific databases, modeling expertise, and "corporate knowledge" of monitoring, modeling, and interpretation exist within the cooperating organizations. No other experimental range or watershed program has such a rich background of three decades of "pretreatment" baseline results on paired watersheds to begin a carefully designed and long-term adaptive management research program.

References

- Carlson, D. H.; Thurow, T. L.; Knight, R. W.; Heitschmidt, R. K. 1990. Effect of honey mesquite on the water balance of Texas Rolling Plains rangelands. *Journal of Range Management*. 43(6): 491-496.
- Diskin, M. H.; Lane, L. J. 1976. Application of a double triangle unit hydrograph to a small semiarid watershed. Tucson: University of Arizona, Office of Arid Land Studies. *Hydrology and Water Resources in Arizona and the Southwest*. 6: 125-135.
- Goodrich, D. C.; Lane, L. J.; Shillito, R. M.; Miller, S. N.; Syed, K. H.; Woolhiser, D. A. 1997. Linearity of basin response as a function of scale in a semiarid watershed. *Water Resources Research*. 33(12): 2951-2965.
- Green, Christine R.; Martin, S. C. 1967. An evaluation of precipitation, vegetation and related factors on the Santa Rita Experimental Range. *Meteorology and Climatology of Arid Regions Tech. Rep. 17*. Tucson: University of Arizona, Institute of Atmospheric Physics. 82 p.
- Knisel, W. G., ed. 1980. *CREAMS: a field-scale model for chemicals, runoff and erosion from agricultural management systems*. U.S. Department of Agriculture Conservation Res. Rep. 26. 643 p.
- Lane, L. J.; Diskin, M. H.; Wallace, D. E.; Dixon, R. M. 1978a. Partial area response on small semiarid watersheds. *American Water Resources Association, Water Resources Bulletin*. 14(5): 1143-1158.
- Lane, L. J.; Morton, H. L.; Wallace, D. E.; Wilson, R. E.; Martin, R. D. 1978b. Nonpoint-source pollutants to determine runoff source areas. Tucson: University of Arizona, Office of Arid Land Studies. *Hydrology and Water Resources in Arizona and the Southwest*. 7: 89-102.
- Lane, L. J.; Romney, E. M.; Hakonson, T. E. 1984. Water balance calculations and net production of perennial vegetation in the Northern Mojave Desert. *Journal of Range Management*. 37(1): 12-18.
- Lane, L. J.; Hernandez, M.; Nichols, M. 1997. Processes controlling sediment yield from watersheds as functions of spatial scale. *Environmental Modeling and Software*. 12(4): 355-369.
- Lawrence, P. A. 1996. The role of data sources and simulation model complexity in using a prototype decision support system. Tucson: University of Arizona, School of Renewable Natural Resources. 332 p. Dissertation.
- Martin, S. C.; Morton, H. L. 1993. Mesquite control increases grass density and reduces soil loss in southern Arizona. *Journal of Range Management*. 46(2): 170-175.
- Martin, S. C.; Reynolds, H. G. 1973. The Santa Rita Experimental Range: your facility for research on semidesert ecosystems. Tucson: University of Arizona, Office of Arid Land Studies. *Journal of the Arizona Academy of Science*. 8: 56-67.
- McClaran, M. P.; Angell, D. L.; Wissler, C. 2002. Santa Rita Experimental Range digital database: user's guide. Gen. Tech. Rep. RMRS-GTR-100. Ogden, UT: U.S. Department of Agriculture, Forest Service, Rocky Mountain Research Station. 13 p.
- Medina, A. L. 1996. The Santa Rita Experimental Range: history and annotated bibliography (1903-1988). Gen. Tech. Rep. RM-GTR-276. Fort Collins, CO: U.S. Department of Agriculture, Forest Service, Rocky Mountain Forest and Range Experiment Station, 67 p.
- Osborn, H.; Simanton, J. 1989. Gullies and sediment yield. *Rangelands*. 11(2): 51-56.
- Renard, K. G.; Lane, L. J.; Simanton, J. R.; Emmerich, W. E.; Stone, J. J.; Weltz, M. A.; Goodrich, D. C.; Yakowitz, D. S. 1993. Agricultural impacts in an arid environment. *Hydrological Science and Technology*. 9: 145-190.
- Schumm, S. A. 1977. *The fluvial system*. New York: John Wiley & Sons. 338 p.
- Trewartha, G. T.; Horn, L. H. 1980. *An introduction to climate*. 5th ed. New York: McGraw-Hill Book Company. 415 p.

Archive and Laboratory Embedded in the Landscape: Future of the Santa Rita Experimental Range

Abstract: The Santa Rita Experimental Range (SRER) is both an archive of past ecological research and a laboratory for continuing research embedded in the southern Arizona landscape. The scientific questions being asked there have changed over the last 100 years, but SRER with its monitoring stations and its legacy of repeat photography still offers a unique opportunity to study environmental change through time. Now that it belongs to the State of Arizona, however, the Arizona State Land Department (ASLD) could conceivably sell it for commercial development if the Arizona legislature were to revoke its special status for “ecological and rangeland research purposes” administered by the University of Arizona. As metro Tucson, Green Valley, and Sahuarita continue to experience explosive growth, State Trust Lands are being auctioned off to real estate developers. Pima County’s Sonoran Desert Conservation Plan is attempting to preserve biodiversity, open space, cultural resources, and working ranches throughout eastern Pima County. The Santa Rita Experimental Range provides one of the best opportunities to do so on State Trust Lands in the upper Santa Cruz Valley.

Assuming SRER survives for another century, several research topics suggest themselves: (1) the ecological dynamics of exotic Lehmann lovegrass and efforts to eradicate or control it; (2) the impact of urban and exurban development on native wildlife and vegetation; and (3) the development of grass-fed, hormone-free beef and the networks necessary to market it successfully. But all future research must build upon and respect the integrity of the SRER archive with its ongoing record of vegetation change, hydrological and nutrient cycles, and human efforts to manipulate them.

Introduction

The future of the Santa Rita Experimental Range (SRER) can only be comprehended within the context of the dynamic political ecology of twenty-first-century Arizona. This makes forecasting a risky proposition at best. When SRER was created in 1903, Arizona was a largely rural territory dominated by extractive industries, particularly copper mining, irrigated agriculture, and ranching. World War II transformed Arizona’s economy, triggering explosive urban growth. By the end of the twentieth century, Arizona was an overwhelmingly urban State fueled by the service and industrial sectors of its economy (Sheridan 1995). I doubt any seer in 1903 would have predicted a metropolitan Phoenix of three million people, an industrial border zone swelling like a tick on cheap labor and a multibillion dollar illegal drug trade, or a countryside transformed into a playground for urban dwellers.

Research on SRER has reflected the explosive growth of Arizona and the West. SRER was created “to protect the native rangeland from grazing and to conduct research on problems associated with livestock production” (Medina 1996: 1). When D. W. Griffiths initiated research there, Arizona was a lunar landscape in places, its grasslands denuded by more than two decades of unregulated grazing, and its woodlands decimated by indiscriminate timber and fuelwood cutting and grass harvesting (Bahre 1991; Humphrey 1987; Sayre 2002). It was a true tragedy of the commons on the open range because there were no legal mechanisms to regulate grazing or woodcutting on Arizona’s vast public domain (Sheridan 1995).

A century of rangeland reform provided the necessary regulation. The Forest Reserves, which developed into the National Forest system, first introduced exclusive grazing allotments in the early 1900s. The establishment of State Trust Lands after

Thomas E. Sheridan is Research Anthropologist in the Southwest Center and Professor of Anthropology at the University of Arizona; e-mail: tes@email.arizona.edu. He holds a Ph.D. degree in anthropology from the University of Arizona. He is chair of the Ranch Conservation Technical Advisory Team of Pima County’s Sonoran Desert Conservation Plan. His research focuses on the ethnohistory and political ecology of the Southwest and Northern Mexico.

In: McClaran, Mitchel P.; Ffolliott, Peter F.; Edminster, Carleton B., tech. coords. Santa Rita Experimental Range: 100 years (1903 to 2003) of accomplishments and contributions; conference proceedings; 2003 October 30–November 1; Tucson, AZ. Proc. RMRS-P-30. Ogden, UT: U.S. Department of Agriculture, Forest Service, Rocky Mountain Research Station.

Statehood in 1912 extended a similar system to more than 10 million acres selected by ranchers, largely in Arizona's grassland valleys (Sayre 2002). Finally, in 1934, the Taylor Grazing Act regulated grazing on the rest of Arizona's Federal public domain.

Most of the research on SRER during the twentieth century focused on how to make grazing lands more productive. Range scientists developed the Santa Rita System of grazing rotation and struggled to halt the invasion of woody shrubs, particularly mesquite, onto Arizona grasslands. The needs of ranchers dominated SRER's research agenda.

But as Arizona's cities sprawled outward or leapfrogged into desert valleys and mountain meadows, urban needs began to push aside rural concerns. City dwellers wanted open space where they could hunt, fish, hike, camp, ride, and shoot. The growth of the environmental movement brought issues of biological diversity to the forefront, particularly after the passage of the Endangered Species Act in 1973. Because ever-declining proportions of the population made their living off the land, or from industries that processed timber, beef, milk, wool, cotton, or copper, the struggle to make a living in the rural West no longer dictated political debate, even though ranching and mining interests remained disproportionately strong in the Arizona legislature. New and powerful constituencies that privileged recreation or biodiversity over resource extraction increasingly challenged ranchers, loggers, and miners over the management of public lands.

By the beginning of the twenty-first century, researchers were increasingly turning to SRER to ask questions that had nothing to do with range management or beef production. Eleven of the 26 current projects (42 percent) on SRER focus on ecological or geological questions unrelated to range issues, including termite biology and control, the behavior of the swallow-tail butterfly, and seismic imaging of the Santa Rita Fault (Peter Else, personal communication). Even several of the studies that factored in the impact of grazing did so in order to study rates of carbon and nitrogen sequestration in the soil. Such research was driven by climatological, not range management, concerns. SRER had developed into a landscape laboratory with an ever-broadening ecological mission.

State Trust Lands

Meanwhile, residential development crept closer and closer to the boundaries of SRER. The status of SRER itself was not really threatened for the first 73 years of its existence because it belonged to the Federal Government. But in 1988, a convoluted land swap to create Buenos Aires National Wildlife Refuge in the Altar Valley transferred SRER to the Arizona State Land Department (ASLD). Arizona Senate Bill 1249 stipulated that SRER would be utilized by the University of Arizona for "ecological and rangeland research purposes...until such time as the legislature determines the research can be terminated on all or parts of the lands." Given the budget cuts imposed on Arizona universities over the past 15 years, those words are hardly comforting. The fate of the SRER will depend on how the Arizona Legislature values the promotion of research and conservation of open space.

State Trust Lands will be the defining battleground between the forces of development and conservation during the early twenty-first century. Arizona currently has 9,471,000 acres of State Trust Lands, more than any other State in the Union (table 1). Nearly 90 percent of this acreage (8,457,000 acres) is grazed under a system of leases, generally for 10-year periods, unless classified for commercial sale. Until recently, those leases were preferential, but court cases instigated by environmental and public education advocacy groups have initiated an open bidding process. One possible unintended consequence of those decisions is a greater vulnerability to development on State Trust Lands.

Arizona's State Trust Land system began when the Territory of Arizona was established on February 24, 1863. The Act of Congress granted the new territory sections 16 and 36 of each township for the benefit of the "Common Schools." The State Enabling Act (Section 24) of June 20, 1910, allotted two more sections of each township (2 and 32). Four sections of every township in the new State were to be held in trust for public schools. The Enabling Act (Sec. 25) also gave Arizona an additional two million acres to benefit other public institutions including penitentiaries, insane asylums, miners' hospitals, and normal schools (ASLD Historical Overview 2003).

To administer those lands, Arizona's first State Legislature established a three-member State Land Commission.

Table 1—Ten States with Trust Lands greater than one million acres^a.

State	Year of Statehood	Acres granted	Sections granted	Acres in 1995 ^a	Percent original
Arizona	1912	8,093,000	6, 16, 32, 36	9,471,000	117
New Mexico	1912	8,711,000	6, 16, 32, 36	9,217,000	106
Montana	1889	5,198,000	16, 36	5,132,000	99
Utah	1896	5,844,000	6, 16, 32, 36	3,739,000	64
Wyoming	1890	3,473,000	16, 36	3,602,000	104
Colorado	1876	3,686,000	16, 36	2,858,000	78
Washington	1889	2,376,000	16, 36	2,812,000	118
Idaho	1890	2,964,000	16, 36	2,404,000	81
Nebraska	1867	2,731,000	16, 36	1,514,000	55
Oregon	1859	3,399,000	16, 36	1,438,000	42

^aAdapted from Souder and Fairfax 1996.

The Commission wisely decided not to sell State Trust Lands but to manage them for their “highest and best use.” The Commission also recommended that a State Land Department be created to oversee such management in order to maximize revenues for the beneficiaries. The Arizona legislature accepted those recommendations and created a State Land Code in 1915 (ASLD Historical Overview 2003).

Because homesteaders, miners, Indian reservations, National Forests, and other Federal entities had already withdrawn the designated school sections in many townships, the Enabling Act (Sec. 24) granted Arizona the right to select an equal amount of in lieu lands from the Federal public domain. The Arizona State Selection Board, which consists of the Governor, Attorney General, and State Land Commissioner, carries out this process. The board selected most State Trust Lands between 1915 and 1960, through both in-lieu selection and land exchanges with the Federal Government. Those exchanges were originally engineered to create blocks of State Trust Lands rather than isolated sections.

Homesteaders had already preempted most arable land. Federal law prevented the State from acquiring mineral lands. Consequently, the State Selection Board concentrated on acquiring the best grazing lands in Arizona (ASLD Historic Overview 2003). In fact, ranchers often hired brokers in the Arizona State Capitol of Phoenix to make sure the lands they wanted to lease made it through the selection process. As a result, State Trust Lands constitute much of the nonprivate land in Arizona’s grassland valleys, particularly in the central and southeastern parts of the State (Sayre 2002).

As Arizona’s urban centers have expanded, these lands have also become the most attractive for residential development, particularly when they are within an hour’s drive of metropolitan Phoenix, Tucson, Flagstaff, or Prescott. The relentless expansion of metropolitan Phoenix has chewed up much of the private ranch lands originating as homesteads in the Salt River Valley. Moreover, metro Phoenix’s demand for second homes at higher elevations has fueled the conversion of private ranch lands into subdivisions from Kingman

to the White Mountains. Metropolitan Tucson, about 25 percent as large as metro Phoenix, has generated the same relentless demand across much of southeastern Arizona.

As developers run out of private land to subdivide, they are going to exert ever-greater pressure on ASLD to sell off State Trust Lands. ASLD can do so under Arizona’s Enabling Act and Constitution, which mandate that State Trust Lands be managed for their beneficiaries, which now number 14 (table 2). As trust law evolved from its British common law origins, both public and private trusts interpreted “highest and best use” to be the maximization of revenues, not the conservation of natural resources or the preservation of open space or biological diversity (Souder and Fairfax 1996).

For much of the twentieth century, ASLD determined “highest and best use” to be grazing leases. In part, this reflected the low demand for State Trust Lands outside the Phoenix and Tucson basins. Ranchers were also the most powerful constituency of ASLD. The sale or lease of State Trust Lands had to be advertised and opened to competitive bidding at public auctions, where they had to be leased or sold to the “highest and best bidder” (Arizona Enabling Act, Sec. 28). But Section 28 of the Enabling Act also stipulated, “Nothing herein contained shall prevent: (1) the leasing of any of the lands referred to in this section, *in such manner as the Legislature of the State of Arizona may prescribe* (italics mine), for grazing, agricultural, commercial, and domestic purposes, *for a term of five years*” (Arizona Enabling Act 2003). In 1936, the 74th Congress amended the Enabling Act to extend that period to 10 years. The Arizona Constitution (Article 10, Sec. 3) states, “Nothing herein, or elsewhere in article X contained, shall prevent: 1) The leasing of any of the lands referred to in this article in such manner as the legislature may prescribe, for grazing, agricultural, commercial and homesite purposes, for a term of ten years or less, without advertisement” (Arizona Constitution 2003) Ten-year grazing leases became preferential, with current holders able to renew their leases without competition (Sayre 2002).

Table 2—Beneficiaries of Arizona State Trust Lands^a.

Beneficiary	Acres in FY 2001	Percentage of total
Common Schools (K-12)	8,107,420	87.4
Normal Schools	174,808	1.9
University Land Code	138,125	1.5
Agricultural and Mechanical Colleges	125,234	1.4
School of Mines	123,558	1.3
School for the Deaf and Blind	82,662	0.9
Military Institutes	80,168	0.9
State Charitable, Penal, and Reformatory Institutions	77,753	0.8
Penitentiary	76,333	0.8
State Hospital	71,249	0.8
Legislative, Executive, and Judicial Buildings	64,406	0.7
University of Arizona	54,591	0.6
Miners’ Hospital (1929)	47,843	0.5
Miners’ Hospital	47,771	0.5
Total	9,271,921	

^aAdapted from Arizona State Land Department Historic Overview 2003.

As Phoenix and Tucson grew, however, other constituencies challenged the ranchers. Until 1966, many States permitted their trust lands to be dedicated to transportation rights-of-way and other uses that did not generate revenue. But in *Lassen v Arizona Highway Department*, the U.S. Supreme Court ruled, "The Enabling Act unequivocally demands both that the trust receive the full value of any lands transferred from it and that any funds received be employed only for the purposes for which the lands were given" (quoted in Souder and Fairfax 1996). The Arizona legislature reinforced the intent of that decision when it passed the Urban Lands Act in 1981. The act allowed ASLD to include higher land values generated by surrounding planning and zoning regulations in its assessment of full value. In the words of ASLD, "Today the Land Department's urban lands lease and sale program is the largest revenue producer for the Trust" (SLD Historical Overview 2003: 3).

The Arizona State Land Department goes on to say, "Nearly all the most valuable urban Trust land around the northern border of the Phoenix metropolitan area and north and west of Tucson are Common Schools Trust lands. The large block of Trust lands on the south and southeast sides of the Tucson metropolitan area is divided amongst the various institutional Trusts" (SLD Historical Overview 2003:3). The ASLD also notes that 1,628,079 acres of State Trust lands have been sold or exchanged during the 88 years since Statehood (1912–2000).

That figure will undoubtedly increase during the twenty-first century. One report of Pima County's Sonoran Desert Conservation Plan (SDCP) notes that 53,000 acres of State Trust Lands have been reclassified for commercial sale or lease within a 25-mile radius of I-10 and I-19 in Tucson (SDCP Our Common Ground 2000: 11). A recent article in the *Arizona Daily Star* notes that the ASLD is planning to auction off 1,500 acres on the northeast corner of Houghton and Valencia in southeastern Tucson. The city of Tucson's Comprehensive Planning Task Force allows up to eight residential units per acre in the area, so more than 10,000 homes could be constructed on those 1,500 acres alone. Vistoso Partners, LLC, bid \$29.1 million for 1,071 acres of State Trust Lands on the northwest corner of Houghton and Valencia in 2002, almost twice the appraised value of the land (Grubbs 2003).

Such reclassifications affect State Trust Lands that directly border on SRER. As land values escalated south of metropolitan Tucson and along the I-19 corridor, ASLD imposed 5-year limits on 16 grazing permits in eastern Pima County. Eight of these Special Land Use Permits (SLUPs) occur in the Upper Santa Cruz Valley watershed. They comprise 49,000 acres, encompassing 11 percent of the entire area. The largest SLUP runs from Los Reales Road on the north to SRER on the south. Its western boundary is the Santa Cruz River and its eastern border is Corona de Tucson. Ranchers grazing SLUPs can be evicted in 30 days even if their permits are current. Moreover, they will not be reimbursed for any improvements on the State Trust Lands in question. In other words, SLUPs are State Trust Lands reclassified for commercial sale or lease that permit grazing on an interim basis only (SDCP Our Common Ground 2000: 45). Most of the State Trust Lands surrounding SRER will most likely be auctioned off and developed during the next 50 years.

Recently, advocacy groups like the Arizona Gamebird Alliance and Forest Guardians have won several court challenges to ASLD's preferential grazing leases. As it stands now, environmental groups—and developers—can bid against ranchers who have long incorporated grazing leases on State Trust Lands into their ranching operations. Competitive bidding is in its infancy, but it has the potential to drive ranchers who depend on State Trust Lands out of business. Say, for example, a developer wanted to build a subdivision or a resort on a mixture of private and State Trust Land in eastern Pima County. If that developer has deep pockets, he/she could cherry pick State Trust Land grazing leases by outbidding ranchers who have run their cattle on those leases for a generation or more. The removal of such leases would destroy the economic viability of the ranches in question. And because few ranchers can afford to wait 10 years until the leases come up for bid again, the ranchers would be forced to sell their private lands to the developer or subdivide it themselves.

Such cherry picking would accelerate the transition from ranching to real estate development and fragment a once-open landscape. Wildlife corridors would be disrupted. Fire as a natural process or a landscape management tool would be removed from the toolkit. Both legal and illegal recreational impact on the surrounding lands would increase. Biological diversity as well as the ranching economy would suffer (Sheridan 2001).

There is a growing movement to modify the mandate of ASLD and allow some State Trust Lands to be managed for conservation, not maximum economic returns. A broad coalition of environmental groups including The Nature Conservancy, Sonoran Institute, Grand Canyon Trust, and Arizona League of Conservation Voters drafted a proposal to put an initiative concerning State Trust Land Reform on the 2002 ballot. Before doing so, however, a working group of stakeholders encompassing educators, ranchers, developers, conservationists, and business representatives held a series of meetings to see if they could develop an initiative all could support. The working group failed to reach consensus in time for the 2002 elections. The group therefore agreed to continue meeting to hammer out an initiative for 2004. They also signed a forbearance agreement not to undermine the dialogue until they had arrived at a consensus or decided to disband (Arizona League of Conservation Voters 2003).

Despite this delay, the Arizona legislature had already taken a first step to conserve selected State Trust Lands. In 1996, legislators passed the Arizona Preserve Initiative (API). Amended several times since then, API strives to preserve portions of State Trust Lands in and around urban areas as open space. API defines conservation as "protection of the natural assets of State Trust Land for the long-term benefit of the land, the beneficiaries, lessees, the public and unique resources such as open space, scenic beauty, protected plants, wildlife, archaeology, and multiple use values" (ASLD Arizona Preserve Initiative Program 2003: 1).

The Arizona Preserve Initiative also created a process to reclassify State Trust Lands for conservation purposes. Citizens groups, State and local governments, and State land lessees can petition the State Land Commissioner to nominate State Trust Lands for reclassification. After public hearings and studies of the impact of reclassification on

current lessees have been carried out, the Commissioner may reclassify the land in question, enabling it to be leased for up to 50 years or even purchased for conservation purposes. In 1998, Arizona voters provided a funding mechanism for API when they approved Proposition 303, the so-called Growing Smarter Initiative. Proposition 303 allocated \$20 million per year for 11 years to lease, buy, or purchase development rights on State Trust Lands “to conserve open spaces in or near urban areas and other areas experiencing high growth pressure” (Arizona State Parks 2003: 2). As metropolitan Tucson moves south, SRER is likely to qualify for acquisition under those guidelines.

Unfortunately, API has also been challenged. In Tucson, Pima County planned to purchase Tumamoc Hill in Tucson, where the century-old Desert Laboratory is located, and convey it to the University of Arizona. Negotiations have been suspended until the challenge is resolved. If the challenge is ultimately defeated, however, API may offer a mechanism, albeit a potentially expensive one, to preserve SRER in the rapidly developing Santa Cruz Valley. Without additional protection through API—or through the much more difficult process of amending the Enabling Act and Arizona’s constitution to make conservation one of ASLD’s mandates—the Arizona legislature will be increasingly tempted to revoke SRER’s protected status and auction it off to the highest bidder.

Metropolitan Tucson and Urban Sprawl in the Santa Cruz Valley

Development is already lapping at the borders of SRER. Private (156,455 acres; 35 percent) and State Trust Lands (212,745 acres; 47 percent) compose a whopping 82 percent of the Upper Santa Cruz River Valley (449,684 acres) where SRER is located (SDCP Our Common Ground 2000: 40). Private and State Trust Lands abut most of the northern and western boundaries of SRER. The expansion of Green Valley has already spun off several high-end subdivisions including Rancho Sahuarita and Quail Creek along the northwestern side of SRER. Because voters in Green Valley have turned down several attempts to incorporate the community, however, it is difficult to disaggregate Green Valley growth trends from eastern Pima County as a whole.

The formerly agrarian community of Sahuarita, on the other hand, incorporated in 1994, when it had a population of 2,159 residents. Ironically, it did so to preserve its rural character from Green Valley encroachment. Since then, Sahuarita’s population has jumped to 3,242 according to the 2000 census, and its estimated population in July 2002 was 5,455. According to the Pima Association of Governments (2000: 5), “Dramatic growth is anticipated in Sahuarita, both in land size through annexation activity, and in population growth resulting from the development of a 2810 acre master planned residential community. Sahuarita’s growth rate was 99.02% between 1990 and 2000.” In the last decade, Sahuarita has embraced, not restricted, growth.

In 1996, the Pima Association of Governments projected a population of 23,374 in Sahuarita in 2050. That projection is probably low. Sahuarita and other communities in the Santa Cruz Valley will develop even faster in the next

20 years as the City of Tucson expands south and south-east, where private and State Trust Lands have fewer endangered species issues to impede development as they have done in the northwest part of Tucson. Municipal planners anticipate that both Houghton and Sahuarita roads will become major corridors of residential development as well as transportation as metro Tucson’s population continues to increase. This will intensify development north and east of SRER in addition to accelerated development along the I-19 corridor in the Green Valley-Sahuarita areas.

Even though medium- and high-density developments are being built in southeastern Tucson and Green Valley, other residential and commercial development will undoubtedly mimic long-established patterns in metropolitan Tucson itself. Ever since the 1960s, Tucson’s growth has been increasingly land extensive. In 1930, when Tucson’s population was 32,506, there were 4,526.7 persons per square mile in the city. That density rose slowly through the 1960 census, and then began to fall: 3,306.0 in 1970; 3,344.1 in 1980; 2,573.3 in 1990; and 2,490.7 in 2000. In 1990, a staggering 35 percent of land within the incorporated limits of the City of Tucson was undeveloped. Because land is generally cheaper on the edges of an urban center, demand and the housing market have provided bigger lots in new subdivisions, not greater urban densities and infilling within existing municipal boundaries. The result is urban sprawl and exurban leapfrogging as 13 acres of desert a day—nearly 5,000 acres a year—are bulldozed.

A consensus seems to be emerging among City of Tucson and Pima Association of Governments prognosticators that eastern Pima County will have a population of about 1.7 million people by 2050, twice as many people as live here now (table 3). Like estimates in the past, those projections may be too high (Pima County 2002). Regardless of the numbers, however, growth will be relentless. If Pima County’s ambitious Sonoran Desert Conservation Plan goes into effect, much of that growth will be channeled south and southeast of metro Tucson. That puts SRER on a collision course with urban sprawl and exurban leapfrogging.

Even if SRER itself escapes development and is preserved as open space devoted to scientific research, the impacts of development will nonetheless intensify. SRER has been open to hunting since it came under the jurisdiction of ASLD. Traffic from drug runners and undocumented

Table 3—Population projections for Pima County^a.

Year	Arizona	Pima County
1999	4,595,375	836,153
2000	4,961,950	854,329
2010	6,145,125	1,031,623
2020	7,363,625	1,206,244
2030	8,621,050	1,372,319
2040	9,863,625	1,522,615
2050	11,170,975	1,671,182
Change 1999 to 2050	6,575,600	835,029
Percent change 1999 to 2050	143.1	99.8

^aAdapted from Pima Association of Governments and Arizona Department of Economic Security (based on July 1, 1996).

workers seeking employment also has intensified in the last decade and shows no signs of abating. As any rancher in southern Arizona will tell you, more hunters, target shooters, drug runners, and undocumented crossers mean more open gates, cut fences, punctured water lines, and trash. Such traffic also jeopardizes the safety of researchers and the security of research equipment.

Increasing numbers of people living along SRER's borders will also increase other legal and illegal activities as well—poaching, wildcat dumping, pothunting of archaeological resources, vandalism of research equipment, soil disturbance resulting from ORVs, and depredation of wildlife by pets or abandoned cats and dogs. To ensure the integrity of the landscape, not to mention safety and security of personnel and equipment, SRER will have to intensify its onsite vigilance or risk seeing its research resources seriously erode.

Sonoran Desert Conservation Plan

One glimmer of hope is a rising demand for open space among residents of eastern Pima County, including people in Green Valley and other communities of the Upper Santa Cruz Valley. In 1999, a coalition of environmentalists, astronomers, and neighborhood associations in Green Valley and Elephant Buttes persuaded the Pima County Board of Supervisors to reject a request for rezoning the southern half of the historic San Ignacio de la Canoa Land Grant comprising some 6,000 acres by Fairfield Homes. It was the first time the Board of Supervisors—by a vote of 4 to 1—had denied a major rezoning in 25 years (Hadley 2000; Sheridan 2000). A series of occasionally bitter negotiations eventually resulted in an approved rezoning that allowed Fairfield Homes to build homes and a golf course west of I-19 and to develop commercial properties along a strip east of the freeway around the Canoa Road interchange. Approximately 4,800 acres, or 80 percent of Canoa Ranch, on the other hand, was not rezoned. Pima County later purchased that portion of the Canoa land grant as a county preserve.

Similar battles over rezoning and development are being waged across eastern Pima County. The most comprehensive attempt to control urban growth and to protect biodiversity, cultural resources, working ranches, and open space is Pima County's Sonoran Desert Conservation Plan (SDCP). The listing of the cactus ferruginous pygmy owl as endangered in 1997 triggered the SDCP. In 1998, the Pima County Administrator and his staff decided to seek a Section 10 permit under the Endangered Species Act (ESA) to avoid site-by-site battles over development and to protect the County from lawsuits brought by environmental groups such as the Center for Biological Diversity. A Section 10 permit requires a permittee to develop a Habitat Conservation Plan (HCP). In return for adopting specified conservation measures and practices designed to minimize and mitigate impacts on covered species, an HCP protects the permittee from being sued or prosecuted for incidental take. HCPs are designed to protect critical habitat while at the same time offering security to property owners and municipalities on lands that are not so designated.

Rather than simply applying for a permit covering the pygmy owl, however, the County decided to develop a multispecies HCP to avoid expensive and time-consuming species-by-species mitigation. At the time, eastern Pima County was home to seven species that already had been listed as threatened or endangered, and 18 more that had been proposed or petitioned. The County therefore initiated a process to identify other "species of concern." Pima County wanted an HCP that would channel urban growth and development into areas of lower biological diversity while protecting core areas of critical habitat for listed species and other species that might be listed in the future. In addition, Pima County sought to update its Comprehensive Land Use Plan and included conservation of cultural resources, working ranches, riparian areas, and mountain preserves.

To determine which species needed to be protected, the County created a Science Technical Advisory Team (TAT) composed of wildlife biologists and agency personnel who manage wildlife. It also hired a biological consulting firm—RECON of San Diego—to prepare an HCP that would serve as the *biologically* preferred alternative. "The goal of the Science TAT and RECON was to identify vulnerable species of concern and their potential critical habitats. The County attempted to erect a so-called "firewall" to shield the Science TAT and RECON from political pressure" (Davis 2001). The two independent peer reviewers of the Sonoran Desert Conservation Plan—Reed Noss, Ph.D., and Laura Hood Watchman, M.S.—praised Pima County's "demonstrated commitment to keeping science insulated from politics....The autonomy of the scientists (including the STAT, the consultants, and the expert reviewers) in the Plan allows them to exercise their best scientific judgment about what it takes to fulfill the primary goal of the conservation plan—preserving the biodiversity of the region" (Noss and Watchman 2001).

The County also established a Cultural Resources TAT to identify where vulnerable archaeological and historical sites were located. Not surprisingly, the greatest densities of such sites were along riparian corridors, which were the areas of greatest biological diversity as well.

Thirdly, the County set up a Ranch Conservation TAT. The County pointed out that working ranches had defined metropolitan Tucson's urban boundaries for more than a century. Despite the objections of some environmentalists, it also argued that keeping working ranches in business was the cheapest and most effective way to preserve open space in eastern Pima County. Despite some later problems, this recognition encouraged ranchers to participate in the process.

The County assigned staff to the three TATs and charged them with gathering information to help develop the HCP. During the first 4 years of the SDCP, however, the Science TAT and RECON received the lion's share of the resources because Federal funding for SDCP was restricted to the biological elements of the plan. After several years of intense consultation and review, the Science TAT identified 55 species of concern. RECON then crafted the biologically preferred alternative, proposing a system of biological core reserves, which were renamed Biological Core Management Areas. The criteria for selection were areas where there were "high potential habitat for five or more vulnerable species, special elements (e.g. caves, perennial streams, cottonwood-willow forests), and other unique biological features." The

County went on to say, “Land use and management within these areas will focus on conservation, restoration, and enhancement of natural communities, with provision for other land uses that are consistent with improvement of conditions for ‘vulnerable species,’ soils, and native vegetation” (CLS Map 2/2002). Biological Core Management Areas encompass more than 800,000 acres—one-third of eastern Pima County (2,443,141 acres). SDCP therefore became the largest HCP being proposed in the United States.

The Santa Rita Experimental Range is considered part of a Biological Core Management Area except for the northwestern corner, which is called a “Scientific Research Management Area.” The County therefore wants SRER—some 53,159 acres—to remain undeveloped and free of any land uses that would diminish or destroy critical habitat. One of the major limitations of SDCP, however, has been the refusal of the State Land Department to participate. Despite its location within a Biological Core Management Area, the County could not prevent the State Land Department from leasing or selling SRER as commercial property if the Arizona legislature were to revoke its special status as a research range. Both Tumamoc Hill’s Desert Laboratory and SRER were established in 1903 to monitor desert and grassland environments. It is ironic that during their centennial year, both may be threatened by sale and development.

Archive and Laboratory Embedded in the Landscape

As the Upper Santa Cruz Valley develops, open space will become even more precious for ecological as well as aesthetic reasons. SRER provides the largest bridge in the wildlife corridor linking the northern Santa Rita Mountains to the Sierrita and Cerro Colorado Mountains to the west. This corridor has been fragmented by development in and around Green Valley and Sahuarita. The I-19 freeway also truncates the corridor by imposing a perilous obstacle to mammals and reptiles attempting to move east and west. In the future, however, animal-friendly underpasses may be constructed. The conservation of Canoa Ranch was a critical first step in maintaining this corridor. Keeping SRER development free would be an essential second step. A third major step—the preservation of Sopori Ranch, which straddles Pima and Santa Cruz counties—will require much more mobilization and money to achieve.

The Santa Rita Experimental Range, however, is far more than open space or wildlife habitat. As the oldest active research range in the United States, SRER is both a landscape laboratory and a unique ecological archive with a century of research embedded in its soil, watersheds, and vegetation. If scientists are ever going to understand the complexities of arid and semiarid ecosystems, they have to be able to conduct long-term studies that preserve, and build upon, the studies of the past. Synchronic snapshots of a landscape, like those of a culture ethnographers engender, are nothing more than stages in the process of investigating dynamic, ever-changing systems. Taken alone, they may offer simplistic, distorted, even misleading glimpses of the system in question. Short-term economic considerations must not be allowed to obliterate the soils and vegetation

that encode these 100 years of past research in their ever-changing physical, chemical, and community structures.

It is impossible to foresee all future research directions that may arise during the next 100 years. SRER will probably never be dominated by research designed to improve the livestock industry as it was for much of its first century. Grazing is a relatively small part of Southwestern economies now, and scientists are responding to other constituencies and other concerns. More to the point, the notion that SRER—or any other experimental range or biological reserve, for that matter—can serve as an ecological analogue for an entire region has been undermined, as the limitations of Clementsian equilibrium models of plant succession and climax vegetation communities in semiarid regions have been exposed. Landscapes are ever-changing products of historical forces, both natural and anthropogenic, not Platonic templates waiting to be restored to their true essences. Range science—and the accumulating experience of conscientious ranchers—increasingly recognize that range management must be tailored to individual landscapes as they change from season to season and year to year (Sayre 2001).

That same appreciation for the historical dynamism of semiarid ecosystems applies to nonrange ecological research as well. But as the validity of atemporal space is challenged, a growing appreciation for time has surged. Using repeat photography, Rodney Hastings and Raymond Turner (1965) drew attention to the importance of historic climate change 40 years ago in their classic *The Changing Mile*. Turner and his colleagues have recently updated that work, carefully evaluating the “tangle of hypotheses”—both “climatic and cultural”—advanced to explain vegetation change in the Sonoran Desert region (Turner and others 2003: 276). Researchers like David Griffiths (1904, 1910), Wooten (1916), and Parker and Martin (1952) pioneered the technique on SRER. As McClaran (this proceedings) notes, “Currently, the repeat photography collection is one of the largest and most accessible in the world.”

The Santa Rita Experimental Range also has provided a laboratory for the systematic remeasurement of precipitation patterns, vegetation, and experimental manipulations of the landscape. Again, to quote McClaran (this proceedings), “The most incontestable conclusion from this century of vegetation change is that future changes can not be perceived and understood if there are no records of previous conditions.” Such systematic remeasurement has enabled scientists to understand the cyclic nature of burroweed and cholla cactus eruptions, to refine estimates of grass response to grazing intensity, to untangle the hypotheses for the spread of mesquite across Southwestern grasslands, and to recognize the temporal limitations of mesquite-eradication programs. Systematic remeasurement is SRER’s greatest scientific legacy—the most important reason why the integrity of SRER must be preserved. The preservation of that integrity must be carried out at the landscape level by protecting SRER from development or any other impacts that would compromise it as a research laboratory. At the same time, however, preservation must extend to the site level as well. Future experiments must build on the records of the past, and must not interfere with the records of the past. SRER is both a laboratory *and* an archive. Future experimental manipulations of the landscape, whether of

vegetation, soils, or watersheds, should be carefully conducted so they do not diminish or destroy past experiments already embedded in the landscape.

Future Research Directions _____

As I noted at the beginning of this paper, it is impossible to predict all future directions of research on SRER. Nonetheless, I do have a number of suggestions. Currently, tremendous emphasis is placed upon the invasion of non-native exotic species into Southwestern ecosystems and the need to eradicate them and “restore” those ecosystems to some sort of preinvasion state (Tellman 2002). The most widespread exotic invader on SRER in particular and on southeastern Arizona grasslands in general is Lehmann lovegrass (*Eragrostis lehmanniana*). Biological reserves such as the Buenos Aires Wildlife Refuge have devoted considerable resources of money and manpower to combating this perceived threat, without much success.

The Santa Rita Experimental Range should serve as a laboratory to better understand the dynamics of Lehmann lovegrass and to evaluate the effectiveness of manipulations to control or eradicate it. Is its current dominance on some Southwestern grasslands a long-term change or a short-term fluctuation? What sort of systemic changes does its dominance trigger in grassland ecosystems? Is the genie out of the bottle or can the genie be shoved back into the bottle and the bottle corked? And if so, how much time and money is it going to take to do so?

Another research topic garnering enormous attention is the role of fire in grassland and forest ecosystems. Both ranchers and agency land managers alike are re-examining the fire suppression policies of the past and exploring the benefits of letting naturally ignited fires burn. Prescribed fires are also being set to reduce fuel loads, curtail the spread of woody shrubs like mesquite, and improve the productivity and abundance of perennial grasses. Greater experimentation with fire on SRER is problematic for several reasons, however. One has nothing to do with ecology and everything to do with rising property values. Despite increasing recognition of the ecological benefits of fire, agencies continue to suppress any fires within a 5-mile radius of existing commercial or residential structures. As the transition from ranching to real estate development accelerates in the Upper Santa Cruz Valley, the political latitude to let fires burn or to carry out prescribed burns will continue to shrink.

An additional concern is the need to preserve the integrity of previous research on SRER. Any decision about whether to let a natural fire burn or to set a prescribed fire has to be carefully weighed against the “noise” such a fire might introduce into research involving ongoing systematic remeasurements of hydrologic and nutrient cycles, species composition, and other variables. Moreover, the greater adaptability of Lehmann lovegrass over native perennial grasses to fire has to be taken into consideration. Future research directions on SRER must always recognize and mitigate their impacts on long-term studies of environmental change.

Rapid urbanization will, on the other hand, provide wildlife biologists with greater opportunities to investigate the impacts of development on desert grassland fauna. Wildlife

biologists should be encouraged to set up long-term monitoring systems to measure those impacts in a systematic fashion rather than conducting short-term studies of individual species. Aside from climatic change, no other factor is going to influence wildlife dynamics to a greater extent than urban, suburban, and exurban development in the rural West.

Those same forces will affect SRER in other ways that should be studied as well. The spread of exotic plant species from neighboring subdivisions, shopping centers, and roads, the ecological effects of legal and illegal recreational activities, the impact of increased lighting and microclimatological changes brought about by urban heat islands and air pollution—these are just some of the anthropogenic factors that undoubtedly will modify the environment on as well as around SRER. SRER was created to serve rural interests at a time when Arizona was a largely rural society. The balance tipped more than a half-century ago, and now SRER is poised to explore the urban-rural interface that is transforming the State.

Future of Public Lands Ranching _____

But what of SRER’s original mission—range research? In the early 1900s, both scientists and ranchers alike recognized the degradation of Southwestern ranges because of the lethal intersection of overstocking and prolonged drought. At that time, however, livestock grazing was still considered the highest and best—indeed often the only—use of much of Arizona’s arid and semiarid terrain. SRER was designed to demonstrate how ranges could be restored, and how ranching could become a sustainable industry.

Today, many environmentalists call for an end to livestock grazing on Western public lands. Even when ranching is still considered a legitimate use of Forest Service, Bureau of Land Management, and State Trust lands, ranchers have to compete with an ever-growing number of other constituencies—hikers, campers, hunters, birders, and offroad vehicle users, among others—who demand a voice in how public lands are managed. At a time when the costs of inputs continue to rise while cattle prices stagnate, in the midst of another prolonged drought, ranchers face increasing government regulations and a volatile political climate. When you combine these “push” factors with skyrocketing prices for private lands, it is hardly surprising that many ranchers sell out to developers or subdivide their private lands themselves (Knight and others 2002; Sayre 2002; Sheridan 2001).

Is there a future for public-lands ranching in the West? That question is beyond the scope of this paper to answer, even though many of us believe that sustainable ranching should be encouraged for a variety of economic, ecological, and social reasons. One possible strategy to diversify cattle ranching is the development of niche markets for beef. Growing numbers of consumers are becoming increasingly health conscious and environmentally sensitive. The nonvegetarians provide a growing market for beef that is not injected with hormones and finished in feedlots. Moreover, they may prefer to buy locally produced beef because it is so much more energy efficient. And for those consumers who

oppose the killing of predators such as mountain lions and coyotes, and who support the reintroduction of Mexican gray wolves, beef certified as predator friendly may be attractive. But as Will and Jan Holder of Ervin's Beef in eastern Arizona have discovered, such beef is difficult for individual producers or even small groups of producers to achieve.

The Santa Rita Experimental Range has a unique opportunity to explore and nurture such alternative strategies. Experiments in the production of grass-fed, hormone-free, and predator-friendly beef could be conducted on SRER. And because SRER is managed by the University of Arizona, University marketing specialists, agricultural economists, and anthropologists could identify potential markets and investigate ways in which to get those products to consumers. The development of linkages between Arizona producers and Arizona consumers would reduce energy costs, stimulate local economies, and serve as a modest counterpoint to the relentless globalization of the beef industry. This, it seems to me, would be an eminently reasonable twenty-first-century application of the University of Arizona's original land-grant mission.

Conclusions

To ensure that SRER remains intact as a landscape laboratory and archive, the University scientists and staff who manage it need to aggressively build a political constituency—within the University, the State Land Department, the Arizona legislature, and among the public—that will resist any attempt to reverse its special legislative status. More quietly, but just as decisively, SRER advocates should reach out to political allies who will convince the State Land Department and the Arizona legislature to give it special conservation status, either under the Arizona Preserve Initiative or as part of more general State Trust Land reform. Now that SRER will have a manager for the first time since it was transferred to the State Land Department, the manager and the scientists who work with him should establish contacts with the groups who joined together to fight the development of Canoa Ranch. These include environmentalist organizations such as the Coalition for Sonoran Desert Protection, the Smithsonian's Whipple Observatory, and neighborhood associations and citizen's groups in Green Valley and Elephant Butte. Pima County, the University of Arizona, and perhaps even Coronado National Forest also have an interest in keeping SRER as a research range free of development.

Ironically and paradoxically, the very people who move into subdivisions creeping closer and closer to the borders of SRER may become SRER's most enthusiastic advocates. The conservation of 56,000 acres of open space and desert grassland just beyond their back doors should be an attractive proposition for SRER's new neighbors. SRER cannot do much to stem the tide of development around it, so it should embrace the newcomers and let them know what a unique scientific and ecological resource they live next to. A "Friends of SRER" should be formed. Retired professionals should be invited to become stewards of both archaeological and research sites to increase on-the-ground vigilance to prevent vandalism and other illegal activities. Lecture series and field trips focusing on grasslands research and sustainable

ranching should be offered. As anyone who does much public speaking in southern Arizona knows, Green Valley audiences are large and appreciative. Rather than waiting until its status may be threatened, SRER should take positive steps to increase its public visibility and build constituencies that support it.

Research on SRER should also embrace the inevitable. The threats posed by encroaching development can also be turned into opportunities. As more and more desert and grassland valleys are fragmented by subdivisions across Arizona and the West, the need for precise, long-term ecological studies of landscape fragmentation and population growth becomes ever more acute. SRER is a biological reserve in the path of growth, so it is uniquely well positioned to investigate growth's impact upon the flora and fauna of the Upper Santa Cruz Valley.

Finally, SRER should not abandon its first patrons—the ranchers of the Southwest. As Ruyle (this proceedings) points out, many of the principles of sustainable ranching in the semiarid West were tried and tested on SRER. Fundamental monitoring techniques were pioneered there as well. The Santa Rita Experimental Range helped ranchers reverse the degradation of Southwestern ranges and meet the economic and ecological challenges of the twentieth century. It should continue to assist them to meet the very different challenges the twenty-first century is going to pose.

References

- Arizona Constitution. 2003. [Online]. Available: <http://www.azleg.state.az.us/const/10/1.htm>
- Arizona Enabling Act. 2003. [Online]. Available: <http://www.azleg.state.az.us/const/const.htm>
- Arizona League of Conservation Voters. 2003. State trust land reform. [Online]. Available: <http://www.aslcvfund.org/spotlight2.html>
- Arizona State Parks. 2003. Growing smarter grants. [Online]. Available at: <http://www.pr.state.az.us/partnerships/growing-smarter/growing.html>
- ASLD (Arizona State Land Department) Historical Overview. 2003. [Online]. Available: <http://www.land.state.az.us/history.htm>
- ASLD Arizona Preserve Initiative Program. 2003. [Online]. Available: <http://www.land.state.az.us/programs/operations/api.htm>
- Bahre, Conrad Joseph 1991. A Legacy of change: historic human impact on vegetation of the Arizona borderlands. Tucson: University of Arizona Press. 231 p.
- Davis, Tony. 2001. Desert conservation plan "credible": Two environmental scientists laud county move "at the cutting edge." Arizona Daily Star. October 27.
- Else, Peter. 2003. [E-mails to Thomas E. Sheridan]. May 5 and May 14, 2003.
- Griffiths, David. 1904. Range investigations in Arizona. Bureau of Plant Industry Bull. 67. [10 plates]. Washington, DC: U.S. Department of Agriculture. 62 p.
- Griffiths, David. 1910. A protected stock range in Arizona. Bull. 177. Washington, DC: U.S. Department of Agriculture. 28 p.
- Grubbs, Nicole R. 2003. 10,000+ homes envisioned: State to sell land near Valencia and Houghton. Arizona Daily Star. May 15: B1, B5.
- Hadley, Diana. 2000. San Ignacio de la Canoa land grant and Canoa Ranch history/timeline. SMRC-Newsletter. 34 (123): 11–15.
- Hastings, James Rodney; Turner, Raymond M. 1965. The changing mile: an ecological study of vegetation change with time in the lower mile of an arid and semiarid region. Tucson: University of Arizona Press. 317 p.
- Humphrey, Robert R. 1987. 90 years and 535 miles: vegetation changes along the Mexican border. Albuquerque: University of New Mexico Press. 448 p.

- Knight, R. L.; Gilgert, W. C.; Marston, E., eds. 2002. *Ranching west of the 100th Meridian: culture, ecology, and economics*. Washington, DC: Island Press. 368 p.
- Medina, Alvin L. 1996. *The Santa Rita Experimental Range: annotated bibliography (1903–1988)*. Gen. Tech. Rep. RM-GTR-276. Fort Collins, CO: U.S. Department of Agriculture, Forest Service, Rocky Mountain Forest and Range Experiment Station. 67 p.
- Noss, Reed; Watchman, Laura Hood. 2001. Report of independent peer reviewers: Sonoran Desert Conservation Plan. October 26.
- Parker, Kenneth W.; Martin, S. Clark. 1952. The mesquite problem on southern Arizona ranges. *American Hereford Journal*. 31(6): 23.
- Pima Association of Governments. 2000. *PAG Census 2000 Information Page*. [Online]. Available: <http://www.pagnet.org/Population>
- Pima County. 2003. *Cost model for Section 10 Endangered Species Act permit for the unincorporated area of eastern Pima County*. Pima County, AZ: Tucson.
- Sayre, Nathan F. 2001. *The new ranch handbook: a guide to restoring Western rangelands*. Santa Fe: The Quivira Coalition. 102 p.
- Sayre, Nathan F. 2002. *Ranching, endangered species, and urbanization in the Southwest: species of capital*. Tucson: University of Arizona Press. 278 p.
- Sheridan, Thomas E. 1995. *Arizona: a history*. Tucson: University of Arizona Press. 434 p.
- Sheridan, Thomas E. 2000. La Canoa: from land grant to political football. *SMRC-Newsletter*. 34(123): 2–5.
- Sheridan, Thomas E. 2001. Cows, condos, and the contested commons: the political ecology of ranching on the Arizona-Sonora borderlands. *Human Organization*. 60(2): 141–151.
- SDCP (Sonoran Desert Conservation Plan). 2000. *Our common ground: ranch lands in Pima County*. Tucson, AZ: Pima County.
- Souder, Jon A.; Fairfax, Sally F. 1996. *State trust lands: history, management, and sustainable use*. Lawrence: University Press of Kansas.
- Tellman, Barbara, ed. 2002. *Invasive exotic species in the Sonoran region*. Arizona-Sonora Desert Museum studies in natural history. Tucson: University of Arizona Press and Arizona-Sonora Desert Museum. 424 p.
- Turner, Raymond M.; Webb, Robert H.; Bowers, Janice E.; Hastings, James Rodney. 2003. *The changing mile revisited: an ecological study of vegetation change with time in the lower mile of an arid and semiarid region*. Tucson: University of Arizona Press. 334 p.
- Wooten, E. O. 1916. Carrying capacity of grazing ranges in southern Arizona. *Bull.* 367. Washington, DC: U.S. Department of Agriculture. 40 p.

Climate Variability and Plant Response at the Santa Rita Experimental Range, Arizona

Abstract: Climatic variability is reflected in differential establishment, persistence, and spread of plant species. Although studies have investigated these relationships for some species and functional groups, few have attempted to characterize the specific sequences of climatic conditions at various temporal scales (subseasonal, seasonal, and interannual) associated with proliferation of particular species. Research has primarily focused on the climate conditions concurrent with or occurring just prior to a vegetation response. However, the cumulative effect of antecedent conditions taking place for several consecutive seasons may have a greater influence on plant growth.

In this study, we tested whether the changes in overall cover of plant species can be explained by antecedent climate conditions. Temperature, precipitation, and Palmer Drought Severity Index (PDSI) values at various lags were correlated with cover. PDSI had the strongest correlations for several drought-intolerant species at lags up to six seasons prior to the sampling date. Precipitation, surprisingly, did not correlate with species cover as strongly as PDSI. This is attributed to PDSI capturing soil moisture conditions, which are important to plant growth, better than raw precipitation measurements. Temperature correlations were weak and possessed little explanatory power as predictors of species cover.

Acknowledgments: Data sets were provided by the Santa Rita Experimental Range Digital Database. Funding for the digitization of these data was provided by the USDA Forest Service Rocky Mountain Research Station and the University of Arizona.

Introduction

Climatic variability is reflected in differential establishment, persistence, and spread of plant species. Although studies have investigated these relationships for some species and functional groups (Ibarra and others 1995; Martin and others 1995; Neilson 2003; Neilson and Wullstein 1983), few have attempted to characterize the specific sequences of climatic conditions at various temporal scales (subseasonal, seasonal, and interannual) associated with proliferation of particular species. Research has primarily focused on the climate conditions concurrent with or occurring just prior to a vegetation response. However, the cumulative effect of antecedent conditions taking place for several consecutive seasons may have a greater influence on plant growth.

Our objective in this study was to test whether the changes in percent cover of individual plant species can be explained by climatic conditions at different time scales. We investigated this relationship for native perennial grasses using long-term monitoring data from the Santa Rita Experimental Range (SRER) located in southeastern Arizona, U.S.A.

Methods

Plant cover data for 11 perennial grass species were obtained from the Santa Rita Experimental Range Digital Database. The species included in the analysis were sprucetop grama (*Bouteloua chondrosioides* [H.B.K.] Benth.), sideoats grama

Michael A. Crimmins is currently a Ph.D. Student in the Department of Geography, Harvill Building, Box 2, University of Arizona, Tucson, AZ 85721; e-mail: crimmins@u.arizona.edu. He completed a B.S. degree in atmospheric sciences from the University of Michigan and an M.A. degree in geography from Western Michigan University. Theresa M. Mau-Crimmins is currently pursuing a Ph.D. degree in the School of Renewable Natural Resources at the University of Arizona. She has completed a B.S. degree in biology and an M.A. degree in geography from Western Michigan University.

In: McClaran, Mitchel P.; Ffolliott, Peter F.; Edminster, Carleton B., tech. coords. Santa Rita Experimental Range: 100 years (1903 to 2003) of accomplishments and contributions; conference proceedings; 2003 October 30–November 1; Tucson, AZ. Proc. RMRS-P-30. Ogden, UT: U.S. Department of Agriculture, Forest Service, Rocky Mountain Research Station.

(*Bouteloua curtipendula* [Michx.] Torr.), black grama (*Bouteloua eripoda* Torr.), slender grama (*Bouteloua filiformis* [Fourn.] Griffiths), hairy grama (*Bouteloua hirsuta* Lag.), Rothrock grama (*Bouteloua rothrockii* Vasey), Arizona cottontop (*Digitaria californica* [Benth.] Henr.), tanglehead (*Heteropogon contortus* [L.] Beauv.), curly mesquite (*Hilaria belangeri* [Steud.] Nash), bush muhly (*Muhlenbergia porteri* Scribn.), and plains bristlegrass (*Setaria macrostachya* H.B.K.). Cover measurements, taken on all transects all sampling years, were aggregated by species for each sampling year and normalized by dividing the total by the number of observations. Pastures on the SRER have been grazed for many decades using various rotations. However, data for this study were not stratified by grazing rotation because differences in grass density and grazing rotations were detected for only one species in this study, *Muhlenbergia porteri* (Angell and McClaran 2001; Martin and Severson 1988).

We primarily focused on the SRER plant cover data for this study because the period of record (47 years) is much greater than that for density measurements (28 years). Data from 1953 to 1984 were analyzed in this study. Changes in both personnel carrying out the field work and season of the work (from autumn to spring) reduced the comparability of data collected throughout the entire period of record, 1953 to 2000. Many species demonstrate marked increases or decreases in cover between the period 1953 to 1984 and the period 1991 to 2000. There are several candidate explanations for this significant change in cover measurements. In 1991, the sampling was taken over by a different group of individuals than had performed the previous sampling. It is possible that observer bias played a role in the differing measurements. Additionally, samples taken during the 1953 to 1984 period were recorded in late summer or autumn while the 1990s data were collected in winter. A number of the grass species in this study exhibit low C:N ratios, leading to their quick breakdown following the growing period. This would cause some species to be under-represented when sampled in winter, and others to be over-represented when not sampled during the growing season. Finally, the introduced nonnative perennial bunchgrass *Eragrostis lehmanniana* heavily invaded the SRER between 1984 and 1990. The presence of *E. lehmanniana* may be influencing the cover of other native grasses. Confounding of both observer and season suggest that the data collected during the 1991 to 2000 period should be analyzed separately from the 1953 to 1984 data.

Five climate variables were used in the lagged correlation analysis. Four of the variables, including daily total precipitation (PPT), minimum temperature (TMIN), maximum temperature (TMAX), and mean temperature (TMEAN), were measured at the Santa Rita Experimental Range through the cooperative observer program of the National Weather Service on a daily basis. These data were obtained from the National Climatic Data Center (NCDC). The fifth variable, the Palmer Drought Severity Index (PDSI), was obtained for climate division #7, representing five counties in southeastern Arizona, from NCDC. The PDSI values were calculated from temperature and precipitation measurements from across southeastern Arizona and represent an area-wide indication of soil moisture conditions.

Daily data (PPT, TMEAN, TMIN, TMAX) and monthly data (PDSI) were combined into seasonal averages for the period from 1950 to 1984. Seasons were defined as winter (DJFM), spring (AMJ), summer (JAS), and autumn (ON). These definitions differ from the convention of even 3-month seasons, but are more appropriate for the unique seasonality of precipitation and temperature in southern Arizona. Precipitation is bimodal with 30 percent falling in DJFM and 50 percent falling during the monsoon season of JAS (WRCC 2003). The adjusted definitions are more sensitive to these seasonal variations in precipitation.

For each season in the study period, precipitation amounts were summed and all other variables averaged. This resulted in four seasonal values for each year for the period from 1950 to 1984. The time series of seasonal climate variables was matched to the time series of species cover measurements sampled at various years between 1950 and 1984. Each climate variable was then lagged one to 12 seasons from each sampling date, creating a lagged climate sequence for each species cover amount and each variable. Paired observations were correlated to produce Pearson's *r* values for each species and climate variable at all seasonal lags.

Results

The cover of 11 perennial grass species was tested for correlation with the five climatic variables. Of the 11 grass species, six grass species exhibited significantly positive ($p < 0.05$) correlations with precipitation at one or more seasons (table 1). These species included *B. eripoda*, *B. filiformis*, *B. rothrockii*, *H. contortus*, *M. porteri*, and *S. macrostachya*. Four demonstrated significantly positive ($p < 0.05$) correlations with PDSI at one or more seasons (table 2). These grasses were *B. eripoda*, *D. californica*, *H. contortus*, and *S. macrostachya*. Four species exhibited significantly positive ($p < 0.05$) correlations with TMIN at one or more seasons (table 3). These grasses were *B. eripoda*, *B. rothrockii*, *H. contortus*, and *S. macrostachya*. Results for TMAX and TMEAN were similar to those for TMIN.

Discussion

The Palmer Drought Severity Index accounts for antecedent precipitation, moisture supply, and moisture demand (Palmer 1965). By incorporating accumulated moisture deficiencies or surpluses, it is a better measure of plant-available water. Strong positive relationships between grass cover and PDSI were found for several species in this study. Several species showed significantly positive relationships with PDSI. These species, which include *Bouteloua eripoda*, *D. californica*, *H. contortus*, and *S. macrostachya*, are all drought-susceptible perennial bunchgrasses (Burgess 1995; Herbel and others 1972; Matthews and others 1999). No significant relationships were detected between PDSI at any lag and cover of the perennial bunchgrasses *B. curtipendula*, *B. filiformis*, *B. rothrockii*, *B. chondrosioides*, *B. hirsuta*, *H. belangeri*, and *M. porteri*. These grasses are all considered to be drought tolerant (Judd 1962; Matthews and others 1999; Ruyle and Young 1997; Stubbendieck and

Table 1—Pearson's r correlation coefficients between grasses and precipitation at the Santa Rita Experimental Range, Arizona.

Species	n	JAS (p)	AMJ (p)	DJFM (p)	ON (p)	JAS-1 (p)	AMJ-1 (p)	DJFM-1 (p)	ON-1 (p)
<i>Bouteloua chondrosioides</i>	12	-0.156 (0.628)	0.229 (0.474)	-0.056 (0.863)	-0.399 (0.199)	-0.106 (0.742)	-0.341 (0.278)	-0.123 (0.703)	0.389 (0.211)
<i>Bouteloua curtipendula</i>	14	-0.021 (0.944)	-0.234 (0.420)	-0.039 (0.893)	0.053 (0.857)	-0.147 (0.616)	0.311 (0.279)	0.340 (0.235)	0.303 (0.293)
<i>Bouteloua eriopoda</i>	16	0.250 (0.351)	0.354 (0.179)	-0.151 (0.577)	0.702 ^b (0.002)	0.555 ^a (0.026)	-0.247 (0.357)	0.439 (0.089)	-0.187 (0.488)
<i>Bouteloua filiformis</i>	16	-0.159 (0.557)	-0.004 (0.987)	-0.049 (0.856)	-0.194 (0.472)	-0.286 (0.283)	-0.190 (0.482)	0.001 (0.997)	0.338 (0.200)
<i>Bouteloua hirsuta</i>	16	-0.027 (0.921)	-0.298 (0.262)	0.072 (0.792)	-0.235 (0.381)	0.404 (0.121)	-0.258 (0.335)	0.068 (0.803)	-0.136 (0.614)
<i>Bouteloua rothrockii</i>	16	0.287 (0.281)	0.241 (0.369)	0.027 (0.921)	0.484 (0.058)	0.528 ^a (0.035)	-0.369 (0.160)	0.230 (0.392)	-0.063 (0.815)
<i>Digitaria californica</i>	16	0.074 (0.786)	0.394 (0.131)	-0.070 (0.795)	0.336 (0.204)	0.187 (0.488)	-0.156 (0.563)	0.416 (0.109)	-0.372 (0.156)
<i>Heteropogon contortus</i>	16	0.364 (0.166)	0.535 ^a (0.033)	-0.128 (0.637)	0.698 ^b (0.003)	0.429 (0.098)	-0.078 (0.774)	0.517 ^a (0.040)	-0.319 (0.229)
<i>Hilaria belangeri</i>	16	-0.368 (0.161)	-0.073 (0.787)	-0.065 (0.811)	0.151 (0.578)	-0.156 (0.565)	-0.068 (0.801)	0.096 (0.724)	0.479 (0.061)
<i>Muhlenbergia porteri</i>	16	0.108 (0.690)	0.503 ^a (0.047)	-0.119 (0.660)	0.129 (0.634)	-0.144 (0.594)	-0.063 (0.818)	-0.034 (0.900)	-0.347 (0.187)
<i>Setaria macrostachya</i>	16	0.286 (0.282)	0.465 (0.069)	-0.088 (0.746)	0.610 ^a (0.012)	0.337 (0.202)	-0.177 (0.513)	0.592 ^a (0.016)	-0.375 (0.152)

^a Correlation significant at p < 0.05.

^b Correlation significant at p < 0.01.

Table 2—Pearson's r correlation coefficients between grasses and Palmer Drought Severity Index at the Santa Rita Experimental Range, Arizona.

Species	n	JAS (p)	AMJ (p)	DJFM (p)	ON (p)	JAS-1 (p)	AMJ-1 (p)	DJFM-1 (p)	ON-1 (p)
<i>Bouteloua chondrosioides</i>	12	-0.306 (0.333)	-0.364 (0.245)	-0.555 (0.061)	-0.430 (0.163)	-0.415 (0.180)	-0.342 (0.276)	-0.540 (0.070)	-0.506 (0.094)
<i>Bouteloua curtipendula</i>	14	-0.091 (0.756)	-0.053 (0.857)	-0.150 (0.609)	-0.208 (0.476)	-0.181 (0.535)	0.188 (0.519)	-0.040 (0.892)	-0.193 (0.509)
<i>Bouteloua eriopoda</i>	16	0.503 ^a (0.047)	0.474 (0.064)	0.667 ^b (0.005)	0.752 ^b (0.001)	0.787 ^b (0.000)	0.644 ^b (0.007)	0.668 ^b (0.005)	0.252 (0.346)
<i>Bouteloua filiformis</i>	16	-0.351 (0.183)	-0.305 (0.251)	-0.395 (0.130)	-0.338 (0.201)	-0.224 (0.405)	0.022 (0.935)	-0.037 (0.893)	0.160 (0.555)
<i>Bouteloua hirsuta</i>	16	-0.120 (0.657)	-0.209 (0.438)	-0.195 (0.469)	-0.167 (0.536)	0.000 (0.999)	-0.307 (0.247)	-0.462 (0.072)	-0.552 ^a (0.027)
<i>Bouteloua rothrockii</i>	16	0.397 (0.128)	0.452 (0.079)	0.494 (0.052)	0.475 (0.063)	0.493 (0.052)	0.291 (0.275)	0.301 (0.257)	-0.035 (0.899)
<i>Digitaria californica</i>	16	0.436 (0.091)	0.522 ^a (0.038)	0.472 (0.065)	0.486 (0.056)	0.296 (0.266)	0.226 (0.400)	0.093 (0.733)	-0.237 (0.377)
<i>Heteropogon contortus</i>	16	0.642 ^b (0.007)	0.621 ^b (0.010)	0.706 ^b (0.002)	0.783 ^b (0.000)	0.680 ^b (0.004)	0.585 ^a (0.017)	0.501 ^a (0.048)	0.049 (0.857)
<i>Hilaria belangeri</i>	16	-0.408 (0.116)	-0.267 (0.317)	-0.263 (0.325)	-0.194 (0.471)	-0.053 (0.847)	0.251 (0.373)	0.239 (0.373)	0.102 (0.706)
<i>Muhlenbergia porteri</i>	16	0.276 (0.300)	0.312 (0.239)	0.219 (0.415)	0.306 (0.248)	-0.043 (0.874)	-0.036 (0.896)	-0.063 (0.818)	-0.136 (0.617)
<i>Setaria macrostachya</i>	16	0.555 ^a (0.026)	0.563 ^a (0.023)	0.599 ^a (0.014)	0.681 ^b (0.004)	0.537 ^a (0.032)	0.446 (0.083)	0.328 (0.214)	-0.166 (0.539)

^a Correlation significant at p < 0.05.

^b Correlation significant at p < 0.01.

Table 3—Pearson's r correlation coefficients between grasses and minimum temperature at the Santa Rita Experimental Range, Arizona.

Species	n	JAS (p)	AMJ (p)	DJFM (p)	ON (p)	JAS-1 (p)	AMJ-1 (p)	DJFM-1 (p)	ON-1 (p)
<i>Bouteloua chondrosioides</i>	12	0.184 (0.567)	-0.285 (0.369)	0.155 (0.631)	0.180 (0.575)	0.413 (0.182)	0.208 (0.516)	0.029 (0.928)	-0.134 (0.677)
<i>Bouteloua curtipendula</i>	14	0.131 (0.656)	-0.236 (0.416)	-0.004 (0.990)	0.284 (0.326)	0.393 (0.164)	0.059 (0.842)	-0.136 (0.644)	0.099 (0.735)
<i>Bouteloua eriopoda</i>	16	-0.553 ^a (0.026)	0.149 (0.582)	0.109 (0.687)	-0.389 (0.136)	-0.558 ^a (0.025)	-0.534 ^a (0.033)	-0.530 ^a (0.035)	-0.287 (0.281)
<i>Bouteloua filiformis</i>	16	0.327 (0.216)	0.330 (0.213)	0.484 (0.058)	0.279 (0.296)	0.465 (0.069)	0.032 (0.907)	0.014 (0.958)	0.256 (0.339)
<i>Bouteloua hirsuta</i>	16	-0.083 (0.760)	0.169 (0.530)	-0.022 (0.935)	0.249 (0.352)	-0.196 (0.467)	-0.038 (0.890)	0.092 (0.734)	0.389 (0.136)
<i>Bouteloua rothrockii</i>	16	-0.635 ^b (0.008)	-0.333 (0.207)	-0.527 ^a (0.036)	-0.631 ^b (0.009)	-0.680 ^b (0.004)	-0.857 ^b (0.000)	-0.702 ^b (0.002)	-0.523 ^a (0.038)
<i>Digitaria californica</i>	16	-0.174 (0.519)	0.308 (0.246)	0.026 ^a (0.924)	-0.346 (0.190)	-0.289 (0.277)	-0.303 (0.255)	-0.202 (0.453)	-0.406 (0.118)
<i>Heteropogon contortus</i>	16	-0.527 (0.036)	-0.037 ^a (0.891)	-0.176 (0.513)	-0.569 (0.021)	-0.549 (0.027)	-0.644 (0.005)	-0.473 (0.064)	-0.431 (0.096)
<i>Hilaria belangeri</i>	16	0.419 (0.106)	0.007 ^b (0.979)	0.341 (0.196)	0.130 (0.631)	0.282 (0.290)	0.093 (0.733)	-0.227 (0.398)	0.189 (0.482)
<i>Muhlenbergia porteri</i>	16	-0.084 (0.757)	0.138 (0.609)	-0.058 (0.830)	-0.479 (0.060)	-0.059 (0.829)	-0.010 ^a (0.970)	0.157 (0.560)	-0.523 (0.038)
<i>Setaria macrostachya</i>	16	-0.358 (0.173)	0.098 (0.719)	-0.094 (0.728)	-0.525 (0.037)	-0.491 (0.054)	-0.572 (0.021)	-0.339 (0.199)	-0.366 (0.163)

^a Correlation significant at p < 0.05.

^b Correlation significant at p < 0.01.

others 1985; Weaver and Albertson 1956). Therefore, PDSI can be a good indicator of cover for perennial grasses that are drought susceptible.

Water is the chief abiotic factor affecting the productivity and distribution of grasslands ecosystems (Sala and others 1988; Stephenson 1990). It is "very likely" that precipitation has increased over mid- and high latitude Northern Hemisphere continents by 0.5 to 1 percent per decade since 1900 (IPCC 2001). The ecological impacts of these changes have been documented in ecosystems ranging from tropical marine to polar terrestrial environments (Hughes 2000; Parmesan and Yohe 2003; Root and others 2003), affecting reproduction and species ranges of plants and animals alike. Little work has evaluated the effects of these changing precipitation patterns on the distribution, structure, or composition of plant communities, as a step in understanding future vegetation change. Such changes have implications for the seasonality and intensity of fires, the spread of nonnative species, and the sustainable management of rangelands.

Aggregating climatic data to the season removes extreme events that likely exert the greatest amount of influence on physiological processes such as reproduction and growth. This reduces the predictive power of directly measured climatic variables such as monthly average temperature and monthly total precipitation. Precipitation had a significantly positive correlation with cover of six species at six of the 12 different seasonal lags (table 1). These correlations did not seem to reflect any obvious relationships. We expected to find strong relationships between grass cover and the precipitation of the previous season. Although the grasses in this study are warm season grasses that are known to respond to summer precipitation, we did not find a strong relationship between grass cover and the precipitation of the previous season. We believe these relationships are lacking because precipitation is not necessarily representative of plant-available water. Precipitation is a measure of water reaching the earth, but depending on the amount and intensity of the precipitation event, plants may not be able to use all of the moisture. In addition, plant response to water is a function of the plant's condition. Long periods of drought may stress plants to a point that they do not respond immediately to precipitation.

For three of the four grasses exhibiting significantly positive relationships with PDSI, we see consecutive relationships of seasonal PDSI up to winter of the previous year (six seasons prior). For both *B. eripoda* and *H. contortus*, the first season significantly correlated with cover was winter of the previous year (DJFM-1). The first season correlated with *S. macrostachya* was summer of the previous year (JAS-1). *Digitaria californica* was significantly correlated with PDSI in only one season, winter of the sampling year (DJFM). Two seasons prior also show a strong but insignificant relationship ($p < 0.10$) with PDSI.

The correlations between grass cover and PDSI were assumed to be independent, but PDSI values are dependent on those of preceding seasons due to the water balance accounting inherent in its calculation. Our results of several consecutive seasons significantly correlated with PDSI for these species may be due to this temporal autocorrelation. Nonetheless, successive seasons of high positive PDSI values

(wet conditions) seem to favor greater cover values for these grasses.

A majority of the significant correlations between grass cover and TMIN, TMEAN, and TMAX were negative, that is, higher grass cover amounts were correlated with lower temperatures at various seasonal lags. This counter-intuitive finding is likely due to the inherent relationship between wet periods and cooler temperatures. PDSI captures this relationship due to the inclusion of temperature in the calculation of evapotranspiration. Lower temperatures result in lower rates of potential evapotranspiration and higher soil moisture.

Conclusions

Plant-available water captured in the PDSI explains the greatest amount of variation in plant cover for perennial grasses at the Santa Rita Experimental Range. The strength of the PDSI's explanatory power is that it accounts for antecedent precipitation, moisture supply, and moisture demand. By incorporating accumulated moisture deficiencies or surpluses, it is a better measure of plant-available water than precipitation. Grasses known to be drought-susceptible showed the strongest relationships with PDSI, while drought-resistant grasses demonstrated little or no relationships. A critical finding of this study is the utility of PDSI over precipitation in predicting cover changes for perennial grasses that are drought susceptible.

References

- Angell, D. L.; McClaran, M. P. 2001. Long-term influences of livestock management and a non-native grass on grass dynamics in the Desert Grassland. *Journal of Arid Environments*. 49: 507-520.
- Burgess, Tony L. 1995. Desert grassland, mixed shrub savanna, shrub steppe, or semidesert scrub? The dilemma of coexisting growth forms. In: McClaran, Mitchell P.; Van Devender, Thomas R., eds. *The desert grassland*. Tucson: The University of Arizona Press: 31-67.
- Herbel, C. H.; Ares, F. N.; Wright, R. A. 1972. Drought effects on a semi-desert grassland range. *Ecology*. 53: 1084-1093.
- Hughes, L. 2000. Biological consequences of global warming: is the signal already apparent? *Trends in Ecology & Evolution*. 15: 56-61.
- Ibarra, F. A.; Cox, J. R.; Martin, M. H.; Cowl, T. A.; Call, C. A. 1995. Predicting buffelgrass survival across a geographical and environmental gradient. *Journal of Range Management*. 48: 53-59.
- IPCC. 2001. *Climate change 2001: the scientific basis*. Contribution of Working Group I to the Third Assessment Report of the Intergovernmental Panel on Climate Change. In: Houghton, J. T.; Ding, Y.; Griggs, D. J.; Noguer, M.; van der Linden, P. J.; Dai, X.; Maskell, K.; Johnson, C. A., eds. Cambridge, United Kingdom, and New York: Cambridge University Press. 881 p.
- Judd, B. Ira. 1962. *Principal forage plants of Southwestern ranges*. Station Pap. 69. Fort Collins, CO: U.S. Department of Agriculture, Forest Service, Rocky Mountain Forest and Range Experiment Station. 93 p.
- Martin, S. C.; Severson, K. E. 1988. Vegetation response to the Santa Rita grazing system. *Journal of Range Management*. 41: 291-295.
- Martin, M. H.; Cox, J. R.; Ibarra, F. 1995. Climatic effects on buffelgrass productivity in the Sonoran Desert. *Journal of Range Management*. 48: 60-63.
- Matthews, D.; Pater, M.; Robinett, D.; Munda, B.; Egen, K.; Bailey, C. 1999. *Grasses of southeastern Arizona*. Coronado RC&D Area,

- Inc., and Conservation Districts of Southeastern Arizona, Tucson, AZ. 42 p.
- Neilson, R. P.; Wullstein, L. H. 1983. Biogeography of two South-west American oaks in relation to atmospheric dynamics. *Journal of Biogeography*. 10: 275–297.
- Neilson, R. P. 2003. The importance of precipitation seasonality in controlling vegetation distribution. In: Weltzin, J. K.; McPherson, G. R., eds. *Changing precipitation regimes & terrestrial ecosystems*. Tucson: University of Arizona Press.
- Palmer, W. C. 1965. Meteorological drought. Res. Pap. 45. Washington, DC: U.S. Department of Commerce. 58 p.
- Parmesan, C.; Yohe, G. 2003. A globally coherent fingerprint of climate change impacts across natural systems. *Nature*. 421: 37–42.
- Root, T. L.; Price, J. T.; Hall, K. R.; Schneider, S. H.; Rosenzweig, C.; Pounds, J. A. 2003. Fingerprints of global warming on wild animals and plants. *Nature*. 421: 57–60.
- Ruyle, G. B.; Young, D. J. 1997. *Arizona range grasses*. Tucson: University of Arizona, College of Agriculture, Cooperative Extension.
- Sala, O. E.; Parton, W. J.; Joyce, L. A.; Laurenroth, W. K. 1988. Primary production of the central grassland region of the United States. *Ecology*. 69: 40–45.
- Stephenson, N. L. 1990. Climatic control of vegetation distribution: the role of the water balance. *American Naturalist*. 135: 649–670.
- Stubbendieck, J.; Nichols, James T.; Roberts, Kelly K. 1985. *Nebraska range and pasture grasses (including grass-like plants)*. E.C. 85-170. Lincoln: University of Nebraska, Department of Agriculture, Cooperative Extension Service. 75 p.
- Weaver, J. E.; Albertson, F. W. 1956. *Grasslands of the Great Plains*. Lincoln, NE: Johnsen Publishing Company. 395 p.
- WRCC. 2003. *Arizona climate summaries*. Western Regional Climate Center. Available: <http://wrcc.dri.edu> [2003, February 15].

Erika Geiger
Theresa Mau-Crimmins
Heather Schussman

Spread of a Nonnative Grass Across Southern Arizona: Multiple Data Sources to Monitor Change

Abstract: In 1934, *Eragrostis lehmanniana* was introduced into southeastern Arizona to control erosion and provide forage for cattle. The earliest of these introductions took place on the Santa Rita Experimental Range (SRER) in 1937 and continued there until the early 1960s. Numerous researchers have observed a convincing association between an increased proportion of *E. lehmanniana* and decreasing species richness in these grasslands. This grass is both invasive and persistent: just 50 years after its introduction, the area occupied by *E. lehmanniana* had doubled. Published evidence indicates that variables such as elevation, summer precipitation, winter temperatures, and soils impact its abundance and distribution. We used these variables to generate a map of current predicted distribution of *E. lehmanniana*. Using over 600 presence/absence points amassed from eight agencies in Arizona, we selected among the guidelines to create a current distribution map for *E. lehmanniana* in Arizona. We then modified this map using two common general circulation models developed by the Hadley Centre for Climate Prediction and Research and the Canadian Centre for Climate Modeling and Analysis to predict the potential distribution of *E. lehmanniana* in Arizona in the year 2030.

Introduction

Nonnative plant species have the potential to alter species composition (across guilds), change hydrologic and nutrient cycles, and influence disturbance regimes (Mack and D'Antonio 1998). One particularly invasive species in southern Arizona is *Eragrostis lehmanniana* (Lehmann lovegrass). In the 1930s, *E. lehmanniana* was brought into the Southwestern United States to control erosion and provide forage for cattle. Numerous researchers have observed a convincing association between increasing proportion of *E. lehmanniana* and decreasing species richness in grasslands of southern Arizona (Cable 1971; Bock and others 1986; Medina 1988). In addition to decreased species richness, *E. lehmanniana* has been implicated with alteration of ecosystem processes (Cable 1971; Bock and others 1986; Williams and Baruch 2000), modification of community composition (Anable and others 1992; Kuvlesky and others 2002), and changes in fire regimes (Biedenbender and Roundy 1996; Burquez and Quintana 1994; Ruyle and others 1988). In the 50 years following its introduction, this species doubled the area to which it was originally sown (Cox and Ruyle 1986).

In the mid-1980s, two researchers mapped the then-current distribution of *E. lehmanniana* (Cox and Ruyle 1986) and suggested abiotic factors limiting its distribution. In that study, Cox and Ruyle (1986) predicted that *E. lehmanniana* had reached the limits of its range in many areas. Recently, several respected field ecologists have noted the spread of *E. lehmanniana* to areas well beyond these documented boundaries (D. Robinett 2002, personal communication; G. Ruyle 2002, personal communication). Its spread is expected to continue under current climate conditions and land-management practices (Anable and others 1992; McClaran and Anable 1992).

Erika Geiger is a Ph.D. Student in the School of Renewable Natural Resources at the University of Arizona in Tucson. She completed a B.S. degree in biology from Colorado University in Boulder, CO, and an M.S. degree in range management from the University of Arizona in Tucson. Theresa Mau-Crimmins is a Ph.D. Student in the School of Renewable Natural Resources at the University of Arizona in Tucson, e-mail: theresam@u.arizona.edu. She completed a B.S. degree in biology and an M.A. degree in geography at Western Michigan University in Kalamazoo. Heather Schussman is a Fire Scientist Specialist for The Nature Conservancy, Arizona Chapter. She completed a B.A. degree in biology/anthropology from Whitman College in Washington and an M.S. degree in range management from the University of Arizona in Tucson.

In: McClaran, Mitchell P.; Ffolliott, Peter F.; Edminster, Carleton B., tech. coords. Santa Rita Experimental Range: 100 years (1903 to 2003) of accomplishments and contributions; conference proceedings; 2003 October 30–November 1; Tucson, AZ. Proc. RMRS-P-30. Ogden, UT: U.S. Department of Agriculture, Forest Service, Rocky Mountain Research Station.

Our objectives for this study were to (1) use the abiotic factors suggested by Cox and Ruyle (1986) and other researchers to predict the current distribution of *E. lehmanniana*, and (2) predict areas likely to become invaded by *E. lehmanniana* in the region of Arizona, U.S.A., under a variety of future climate conditions using two popular global circulation models (GCMs).

Methods

We gathered 641 data points from The Nature Conservancy, the USDA Natural Resource Conservation Service, the USDI Bureau of Land Management, Saguaro National Park, Fort Huachuca Military Reservation, Buenos Aires National Wildlife Refuge, the Santa Rita Experimental Range, and the U.S. Forest Service. The data points were coded as presence or absence of *E. lehmanniana*, latitude and longitude, and the date they were recorded.

A descriptive summary statistics analysis was completed (JMP IN Ver. 4.0.4, SAS Institute, Inc.) to identify relationships between abiotic factors and the presence or absence of *E. lehmanniana*. Explanatory variables included average total precipitation, average total summer precipitation (July

through September), average total winter precipitation (December through February), average maximum and minimum temperature, elevation, aspect, and slope.

Cox and Ruyle (1986) predicted spread of *E. lehmanniana* to be limited to areas between 800 and 1,500 m in elevation, with summer rainfall exceeding 150 mm in 40 days, and temperatures rarely falling below 0 °C. In earlier research, Crider (1945) suggested a minimum temperature bound for *E. lehmanniana* of -3 °C. We compared our presence/absence points to the distribution suggested by the abiotic factors described by Cox and Ruyle (1986) and Crider (1945). The current distribution of *E. lehmanniana* was modeled using grid arithmetic within ArcView GIS software. Spatial data sets of long-term climatic averages for minimum January temperature (Thornton and others 1997), annual precipitation (Thornton and others 1997), and corresponding elevation models (GLOBE 1999) were obtained for the study area at 1-km resolution. Based on the ranges of these abiotic factors believed to be tolerated by *E. lehmanniana* (Cox and Ruyle 1986; Crider 1945), spatial grids were coded as either appropriate or inappropriate habitat. When intersected, these grids resulted in a map of the predicted current distribution of *E. lehmanniana* (fig. 1).

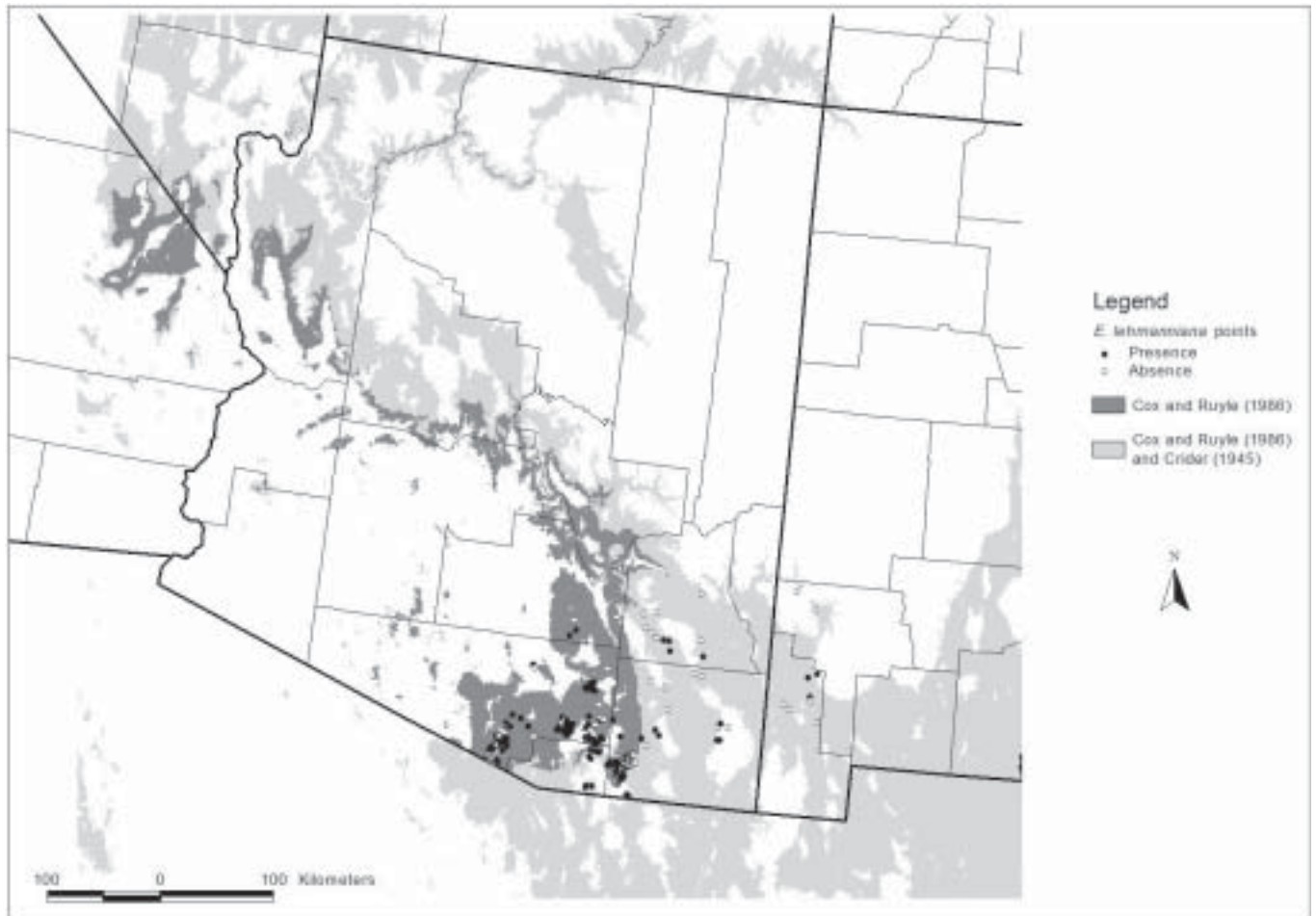

Figure 1—Potential current distribution of *Eragrostis lehmanniana* (Lehmann lovegrass) in Arizona, U.S.A., using abiotic factors suggested by Cox and Ruyle (1986) and Crider (1945).

Potential future distributions of *E. lehmanniana* were predicted using two common general circulation models developed by the Hadley Centre for Climate Prediction and Research and the Canadian Centre for Climate Modeling and Analysis. The long-term climatic data sets for winter temperature and annual precipitation were modified to reflect the changes in winter temperature and annual precipitation predicted for 2030 by each of these models. The Hadley Centre model predicts an average increase in winter temperature of 2.5 °C and winter precipitation of 1.0 mm per day by 2030 for the Southwestern United States. Summer temperature is predicted to increase by 1 °C and 0.25 mm per day, on average, by the Hadley Centre model. The Canadian Climate Centre model predicts an average increase in winter temperature of 3 °C and winter precipitation of 1.5 mm per day by 2030 for the Southwestern United States. Summer temperature is predicted to increase by 1.5 °C and 0 mm per day, on average, by the Canadian Centre model.

The current climate grids were then coded as appropriate or inappropriate habitat for *E. lehmanniana* based on the ranges provided by Cox and Ruyle (1986) and Crider (1945). When intersected with the grid of elevations appropriate

for *E. lehmanniana*, two scenarios of predicted distribution of *E. lehmanniana* in 2030 were generated (fig. 2).

Results

Summary statistics of the 641 data points revealed that *E. lehmanniana* was present in 326 and absent in 227. Sites where *E. lehmanniana* was present were, on average, 265 m lower than sites where it was absent (table 1). Slopes averaged 5.5 percent steeper on sites where *E. lehmanniana* was absent than where it was present (table 1). Sites where *E. lehmanniana* was present received, on average, 6.4 mm less total precipitation annually than sites where it was absent (table 1). Average summer precipitation was 10.2 mm higher for sites where *E. lehmanniana* was absent than sites where it was present (table 1). Average winter precipitation was 2.8 mm higher, on average, for sites where *E. lehmanniana* was absent than sites where it was present (table 1).

The predicted current extent of *E. lehmanniana* using the abiotic factors suggested by Cox and Ruyle (1986) and Crider (1945) appears in figure 1. Areas shaded in dark gray depict

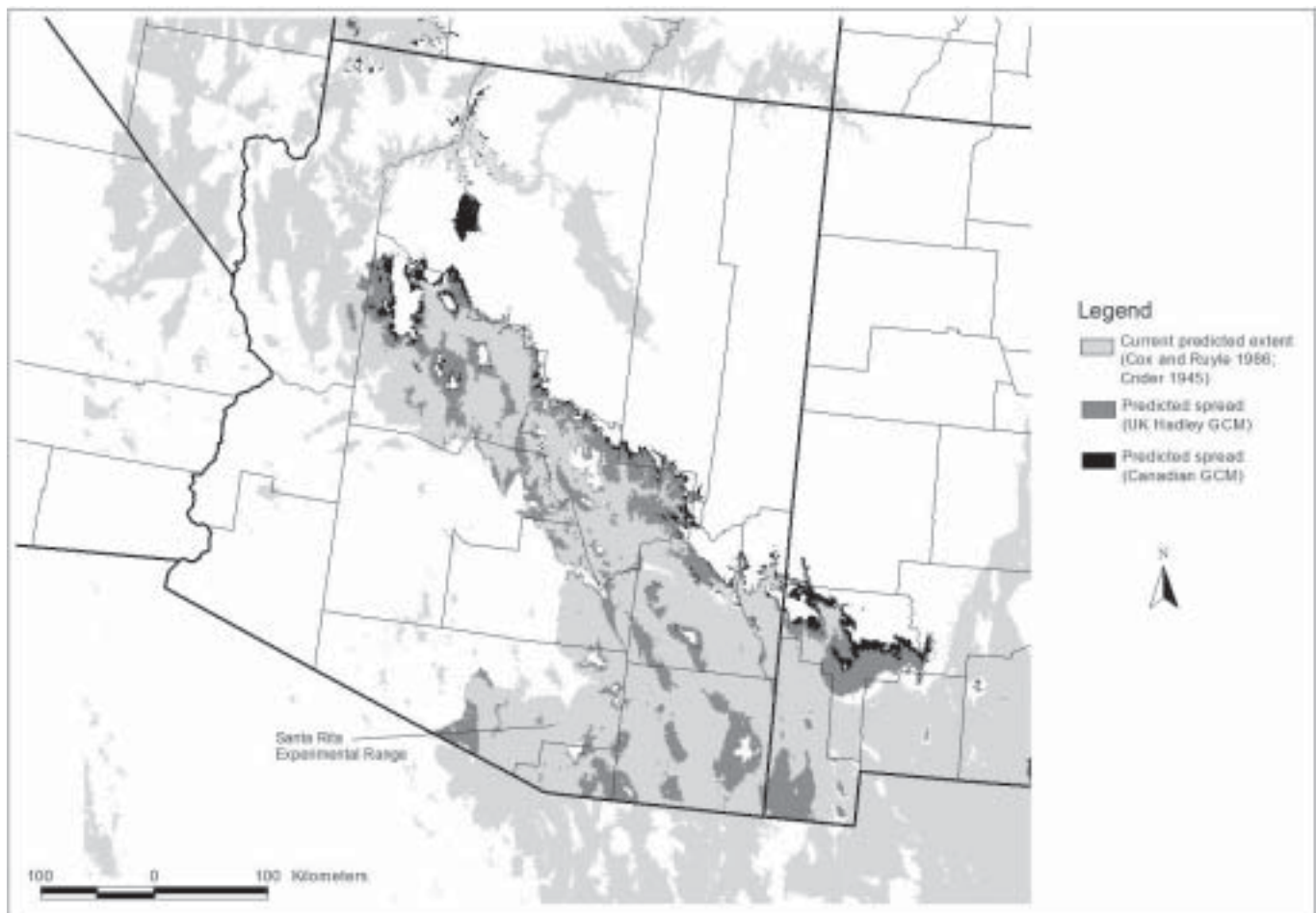

Figure 2—Potential future distribution of *Eragrostis lehmanniana* (Lehmann lovegrass) in Arizona, U.S.A., based on the Hadley Centre for Climate Prediction and Research and the Canadian Centre for Climate Modeling and Analysis general circulation models.

Table 1—Mean values of variables affecting presence of *Eragrostis lehmanniana* in southern Arizona.

<i>E. lehmanniana</i> status	Variable	n	Mean	SE
Present	Elevation	326	1,241 m	11 m
Absent	Elevation	227	1,510 m	31 m
Present	Slope	326	2.3 percent	0.13 percent
Absent	Slope	227	7.8 percent	0.65 percent
Present	Total precipitation	326	505.4 mm	5.5 mm
Absent	Total precipitation	227	511.8 mm	6.2 mm
Present	Average summer precipitation	326	163.7 mm	3.5 mm
Absent	Average summer precipitation	227	173.9 mm	4.8 mm
Present	Average winter precipitation	326	134.8 mm	1.5 mm
Absent	Average winter precipitation	227	137.6 mm	1.6 mm

the range of *E. lehmanniana* using the limits of abiotic factors suggested by Cox and Ruyle (1986). Areas shaded in light gray represent areas that also are predicted to be invaded by *E. lehmanniana* when the minimum cold temperature is changed from 0 °C, as suggested by Cox and Ruyle (1986), to -3 °C, as suggested by Crider (1945). The dark gray areas encompass 63 percent of the 326 presence points we collected; the dark gray and light gray areas together capture 76 percent of the presence points.

Future spread maps, based on the Hadley Centre for Climate Prediction and Research and the Canadian Centre for Climate Modeling and Analysis GCM's are presented in figure 2. These models show the distribution of *E. lehmanniana* increasing, mainly by moving up in elevation. The Canadian Centre model predicts a slightly greater 2030 extent of *E. lehmanniana* than the Hadley Centre model.

Discussion

Several studies have pointed out the importance of average total summer precipitation in limiting the spread of *E. lehmanniana* (Anable 1990; Anable and others 1992; Cox and Ruyle 1986). In our analysis using more than 600 points, we found no meaningful difference between *E. lehmanniana* presence or absence and precipitation. However, elevation and slope substantially affected the presence of *E. lehmanniana*. Of the points we amassed, *E. lehmanniana* was present more often at lower elevations and less steep slopes. Of particular interest is our finding that the upper elevation limit suggested by Cox and Ruyle (1986), 1,500 m, appears to be too low. Of the 327 presence points analyzed in this study, 10 percent existed above the predicted limitation of 1,500 m.

Crider (1945) documented that *E. lehmanniana* could be found in areas with minimum temperature as low as -3 °C, but in these areas, it acted more like an annual plant, reproducing primarily from seed rather than previous years' vegetative growth. This finding may have influenced Cox and Ruyle (1986) when they selected 0 °C as the minimum temperature boundary for *E. lehmanniana*. It appears from the points we collected that *E. lehmanniana* is able to persist at these lower temperatures, as changing the minimum temperature from 0 to -3 °C improved our predictive power of presence points from 63 to 76 percent.

With the model we have constructed using limits of abiotic factors suggested by Crider (1945) and Cox and Ruyle (1986), we predict *E. lehmanniana* to be present in large areas expected to be absent. The map appearing in figure 1 is a representation of areas where the conditions are appropriate to host *E. lehmanniana*. However, myriad other factors play a role in the species' ability to inhabit an area. Factors such as competition, land use history, proximity to seed source, and microsite variability are likely affecting the presence or absence of *E. lehmanniana* in these areas.

The future extent maps (fig. 2) predict that *E. lehmanniana* will move up in elevation as average summer and winter temperatures increase. In addition, areas predicted to currently be invaded in the northwestern portion of the State are no longer predicted to be appropriate for *E. lehmanniana* under future climate conditions. The increase in *E. lehmanniana* presence in Arizona predicted by these is not dramatic compared to the extent already predicted in figure 1. Using the limits suggested by Cox and Ruyle (1986), *E. lehmanniana* is predicted to inhabit 25,680 km²; using the minimum temperature suggested by Crider (1945), this area increases to 81,504 km². Under the Hadley Centre model, 62,314 km² are predicted to be appropriate for *E. lehmanniana*, and under the Canadian Centre scenario, 66,158 km² are predicted to potentially host this invasive grass.

The areas predicted to host *E. lehmanniana* in the future distribution models assume that viable seed is spread to these areas. However, whether *E. lehmanniana* reaches this area will depend on the spread of seed. It has been observed that vehicle traffic is a primary source for seed introductions (D. Robinett 2002, personal communication). Spread of *E. lehmanniana* will likely be driven, at least in part, by development of areas not currently invaded.

Our hope is that the maps we have generated will give a quick up-to-date reference guide for areas throughout the State that are currently occupied by *E. lehmanniana* to aid in planning efforts such as large-scale fire restoration. Additionally, land managers can use the maps to identify where they fall along the current and future distribution of *E. lehmanniana* and adjust management practices as necessary to decrease the spread of *E. lehmanniana* on their lands.

References

- Anable, M. E. 1990. Alien plant invasion in relation to site characteristics and disturbance: *Eragrostis lehmanniana* on the Santa Rita Experimental Range, Arizona 1937–1989. Tucson: University of Arizona. Thesis.
- Anable, M. E.; McClaran, M. P.; Ruyle, G. B. 1992. Spread of introduced Lehmann lovegrass *Eragrostis lehmanniana* Nees. in southern Arizona, USA. *Biological Conservation*. 61: 181–188.
- Biedenbender, S. H.; Roundy, B.A. 1996. Establishment of native semidesert grasses into existing stands of *Eragrostis lehmanniana* in southeastern Arizona. *Restoration Ecology*. 4: 155–162.
- Bock, C. E.; Bock, J. H.; Jepson, K. L.; Ortega, J. C. 1986. Ecological effects of planting African lovegrasses in Arizona. *National Geographic Research*. 2: 456–463.
- Burquez, A.; Quintana, M. 1994. Islands of biodiversity: ironwood ecology and the richness of perennials in a Sonoran Desert biological reserve. In: Nabhan, G. P.; Carr, J. L., eds. *Ironwood: an ecological and cultural keystone of the Sonoran Desert*. Occasional Pap. 1. Washington, DC: Occasional Papers in Conservation Biology: 9–27
- Cable, D. R. 1971. Lehmann lovegrass on the Santa Rita experimental range, 1937–1968. *Journal of Range Management*. 24: 17–21.
- Cox, J. R.; Ruyle, G. B. 1986. Influence of climatic and edaphic factors on the distribution of *Eragrostis lehmanniana* Nees. in Arizona, USA. *Journal of Grassland Society of South Africa*. 3: 25–29.
- Crider, F. J. 1945. Three introduced lovegrasses for soil conservation. U.S. Department of Agriculture Circ. 730.
- GLOBE Task Team. 1999. The Global Land One-kilometer Base Elevation (GLOBE) Digital Elevation Model, Version 1.0. National Oceanic and Atmospheric Administration, National Geophysical Data Center, 325 Broadway, Boulder, CO 80303, U.S.A. Available: <http://www.ngdc.noaa.gov/seg/topo/globe.shtml> [2003, February 15].
- Kuvlesky, W. P., Jr.; Fulbright, T. E.; Engel-Wilson, R. 2002. The impact of invasive exotic grasses on quail in the Southwestern United States. In: DeMaso, S. J.; Kuvlesky, W. P., Jr.; Hernandez, F.; Berger, M. E., eds. *Quail V: the fifth national quail symposium*; Austin, TX: Texas Parks and Wildlife Department: 118–128.
- Mack, M. C.; D'Antonio, C. M. 1998. Impacts of biological invasions on disturbance regimes. *Trends in Ecology and Evolution*. 13: 195–198.
- McClaran, M. P.; Anable, M. E. 1992. Spread of introduced Lehmann lovegrass along a grazing intensity gradient. *Journal of Applied Ecology*. 29: 92–98.
- Medina, A. L. 1988. Diets of scaled quail in southern Arizona (USA). *Journal of Wildlife Management*. 52: 753–757.
- Ruyle, G. B.; Roundy, B. A.; Cox, J. R. 1988. Effects of burning on germinability of Lehmann lovegrass. *Journal of Range Management*. 41: 404–406.
- Thornton, P. E.; Running, S. W.; White, M. A. 1997. Generating surfaces of daily meteorology variables over large regions of complex terrain. *Journal of Hydrology*. 190: 214–251.
- Williams, D. G.; Baruch, Z. 2000. African grass invasion in the Americas: ecosystem consequences and the role of ecophysiology. *Biological Invasions*. 2: 123–140.

Jorry Z. U. Kaurivi
Alfredo R. Huete
Kamel Didan

Multitemporal MODIS-EVI Relationships With Precipitation and Temperature at the Santa Rita Experimental Range

Abstract: The Moderate Resolution Imaging Spectroradiometer (MODIS) provides temporal enhanced vegetation index (EVI) data at 250, 500, and 1,000 m spatial resolutions that can be compared to daily, weekly, monthly, and annual weather parameters. A study was conducted at the grassland site (less than 10 percent velvet mesquite [*Prosopis juliflora*, var. *velutina*]) and the mesquite site (approximately 30 to 40 percent mesquite cover) of the Santa Rita Experimental Range (SRER) to relate MODIS monthly EVI to temperature and rainfall patterns. Preliminary results show that these two climate attributes altered the shape of the temporal EVI regime, particularly at the grassland. High temporal variability in the precipitation regime resulted in a weaker relationship with EVI than the more consistent temperature regime.

Keywords: MODIS, EVI, Santa Rita, mesquite, temperature, precipitation, multitemporal, Southwest

Acknowledgments: Precipitation data sets were provided by the SRER Digital Database. Funding for the digitization of these data was provided by the USDA Forest Service Rocky Mountain Research Station and the University of Arizona. We extend our gratitude to Dr. Mitchel P. McClaran for his guidance and input.

Introduction

Accurate measurements of vegetation dynamics (phenology) at regional to global scale are required to improve models and understanding of interannual variability in terrestrial ecosystem carbon exchange and climate-biosphere interactions (Zang and others 2002). An obvious and appealing approach is to relate the net primary production (NPP) to the climate in order to estimate the efficiency of climate variables to the production of vegetation. Knowledge of the efficiency with which vegetation converts the absorbed photosynthetically active radiation (APAR) into biomass permits an estimate of NPP. Climate constraints on NPP have been studied and have indicated greater consistency in estimates of biomass if APAR is excluded from the annual sum when conditions are unfavorable for production (Turner and others 2002).

The role of precipitation seasonality in arid land systems, although recognized as important, is largely unexplored (Neilson 2003). Together with local elevation and temperature, precipitation determines the distribution and location of vegetation ecotones. With constant competition for water between the grass and shrub communities, the arid Southwest United States vegetation dynamics will better be understood when remote sensing and ancillary data are combined on a multitemporal scale. It has been predicted that the increased precipitation with potential future warming will result in greater distribution of shrubs when winter rains dominate and grass when the summer monsoons are dominant (Neilson 2003).

Perennial grass species have variable net photosynthesis rates as a function of temperature, and this affects the season when a plant is most susceptible to carbohydrate depletion with repeated clipping to simulate grazing. It was shown that mesquite

Jorry Z. U. Kaurivi, Graduate Associate in the Department of Soil, Water and Environmental Science (SWES) of the University of Arizona, Tucson, e-mail: jkaurivi@a.arizona.edu.. He obtained his B.S. degree at the University of Natal, South Africa, and an M.S. degree in soil and water science at the University of Arizona. Alfredo R. Huete, Professor, SWES, and Head of the Terrestrial Biophysics and Remote Sensing Laboratory (TBRS). He obtained a B.S. degree in range ecology in 1977 from the University of Arizona, an M.S. degree in soil and plant biology in 1982 at the University of California-Berkeley, and a Ph.D. degree in soil and water science in 1984 at the University of Arizona. Kamel Didan is a Research Scientist in the TBRS, SWES. He received his Ph.D. degree at the University of Arizona in 1999. He is a MODIS Associate Team Member and leads the research and development of the MODIS VI algorithms.

In: McClaran, Mitchel P.; Ffolliott, Peter F.; Edminster, Carleton B., tech. coords. Santa Rita Experimental Range: 100 years (1903 to 2003) of accomplishments and contributions; conference proceedings; 2003 October 30–November 1; Tucson, AZ. Proc. RMRS-P-30. Ogden, UT: U.S. Department of Agriculture, Forest Service, Rocky Mountain Research Station.

had a higher net photosynthesis rate than galleta grass (*Hilaria jamesii*) at 21 and 38 °C. but that galleta grass had a higher net photosynthesis rate at 5 °C (Ogden 1980).

The Moderate Resolution Imaging Spectroradiometer MODIS, on board the Terra platform, has a temporal resolution of 2 days and acquires data in 36 spectral bands at 250, 500, or 1,000 m spatial resolution. The high temporal resolution provides the capability of monitoring rangeland health worldwide (Reeves and others 2001). Because many land cover changes that are due to the invasion of shrubs upon grasslands occur at spatial scales near 250 m, MODIS may be useful in studying rangeland conversions. The VI product described in this paper is derived from the MODIS-250, 16-day level 3 made available to public on request through the EOS Data Gateway.

The Enhanced Vegetation index (EVI) was developed and incorporated into the MODIS products (Huete and others 2002; Van Leeuwen and others 1999). The EVI utilizes the ratio of the reflectance in the near-infrared band (MODIS 841-876 nm) and the red band (MODIS 620-670 nm). It also employs the blue band (MODIS 459-479 nm) for the atmospheric correction, coefficients (C_1 and C_2) of aerosol resistance, L for the background stabilization and G , the gain factor, as follows:

$$EVI = \frac{(\rho_{NIR} - \rho_{RED})}{L + \rho_{NIR} + C_1 \rho_{RED} - C_2 \rho_{BLUE}} G$$

where

$$L = 1, C_1 = 6, C_2 = 7.5 \text{ and } G = 2.5$$

Vegetation indices have been correlated with various vegetation parameters such as LAI, biomass, canopy cover, and fraction of APAR (fAPAR) (Huete and others 2002). The EVI was found to have a more linear relationship with these parameters than the NDVI. The objective of this study is to present a temporal trend of the MODIS EVI product and relate it to the temperature and precipitation of the SRER mesquite-dominated site (approximated between 30 to 40 percent mesquite cover and located at -110°54'56.92"E, 31°47'3.75"N) and grass-dominated site (less than 10 percent mesquite cover and located at -110°53'44.56"E, 31°46'54.01"N).

Site Description

The SRER (21,500 ha) is 40 km south of Tucson, AZ, and is administered by the University of Arizona. Small areas of steep, stony foothills and a few isolated buttes characterize the range, but the dominating landscape features are the long, gently sloping alluvial fans. Elevations range from 900 m to about 1,300 m in the southwestern part. Average rainfall increases with elevation, from 250 mm at 900 m to almost 500 mm at 1,300 m (McClaran 1995; McClaran and others 2002)

Vegetation at the SRER varies with soil, rainfall, and elevation. Annual vegetation is most abundant in areas with a moderate to low density of perennial grasses and in areas where native grasses persist over the invasive Lehmann's lovegrass (*Erogrostis lehmanniana*, Nees). Since the early

1900s, major vegetation changes have occurred. Where shrub-free grassland once dominated, velvet mesquite (*Prosopis juliflora* var. *velutina*) is now the dominant overstory species (McClarran and others 2002). This site presents a good opportunity for the study of mesquite encroachment into grassland.

Method

We first selected two sites that represent dense mesquite (simply called mesquite site) and the grassland site that has low-density mesquite trees except in the washes. We obtained the temporal vegetation index data from the MODIS-250m, 16-day composite product provided by the EDC-DAAC. Available data from November 2000 to March 2003 were extracted using the Msphinx software and transferred to Sigmaplot software for graphics and S-plus for statistical analysis. The 16-day composite vegetation index was averaged into monthly values for comparison with the monthly climate data sets.

We also obtained the climate data from local weather stations. Local temperature from the Tucson International Airport, which is about 32 km from the study sites, provided a good sample of continuous desert environment temperature. We downloaded the monthly rainfall data of the Rodent and the Exclosure 41 rain gauges from the Santa Rita Web site. The Rodent rain gauge is within the mesquite study site, while the Exclosure 41 rain gauge is within 200 m distance from the grassland site. Precipitation data from the SRER Web site for all the rain gauges until January 2003 was available, and that was the cutoff point for all data sets considered in this study.

Results

Figure 1 shows the multitemporal EVI, temperature, and precipitation profiles from November 2000 to January 2003. High temperature months coincide with the summer monsoon period. The period of low precipitation also corresponds to low EVI value. There was a remarkable difference in the temporal precipitation distribution between the monsoons of 2001 and 2002. The monsoon of the 2001 was better distributed throughout the year and, in fact, there was not a well-defined break between the winter and summer rainy seasons. The year 2002 had little precipitation during winter (December to February), a dry spring (March to May), but a wet summer (June to August) and a small amount during fall (September to November). The temperature profile is more consistent than the precipitation curves. The highest temperature appears in June for the 2 years and lowest during December and January.

The peak EVI appeared in August during 2001 for both the grassland and the mesquite sites. During 2002 the grassland had a sharp rise then a sharp drop in the EVI curve during the period of July to December. The EVI of the mesquite and grassland sites dropped and then rose before the monsoon arrived during the period of November 2001 to May 2002, reaching a minimum in March. During the 2002 season, mesquite had an early rise but did not reach the peak attained by the grassland site after the well-pronounced monsoon precipitation arrived.

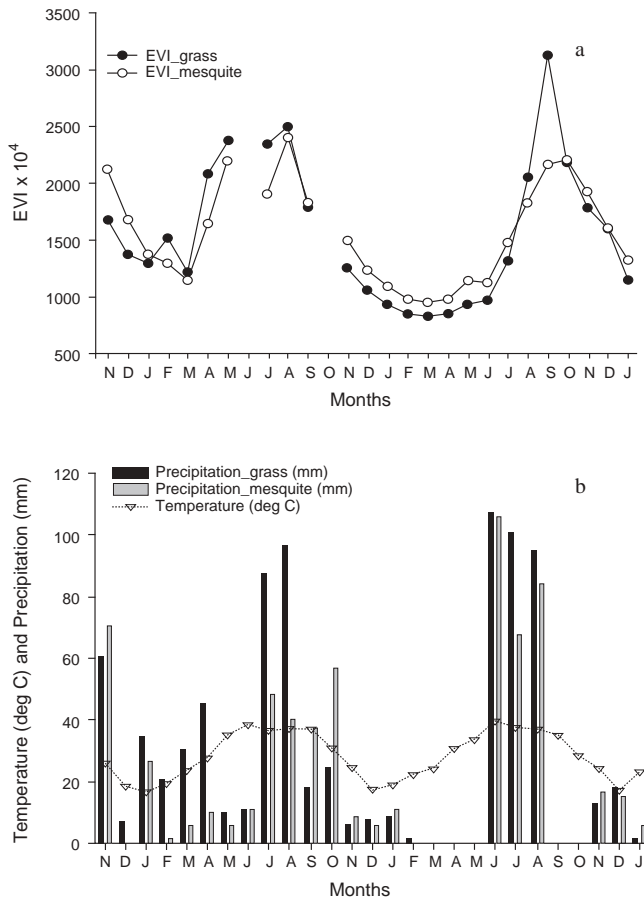

Figure 1—Multitemporal (a) MODIS Enhanced Vegetation Index (EVI) and (b) climate from the Santa Rita mesquite and grassland sites. Data was collected from November 2000 to January 2003. Monthly maximum temperature (°C) was recorded from the Tucson International, and Precipitation at rain gauges Enclosure-41 and Rodent represent the grassland site and mesquite site, respectively.

Figure 2 shows correlation coefficients between temperature, rainfall, and vegetation index from the two sites. The EVI curves of the two sites are predominantly similar, followed by the precipitation and temperature. The grassland site, however, showed a temporal variation that was more correlated to climate attributes than the mesquite site.

Discussion

The EVI, temperature, and precipitation annual sinusoidal curves are out of phase with each other. Temperature is the most consistent variable throughout, followed by the EVI. Warmer months and summer monsoon give rise to high primary production. Low winter temperature reduces the primary production, even when substantial amount of precipitation occurs. Vegetation phenology therefore appears to follow a compromise pattern between precipitation and temperature temporal variations. This vegetation response confirms the importance of monsoon and warm temperature to desert grasslands that characterizes the C₄ photosynthetic pathway (McClaran 1995). Winter and spring rains induce an early takeoff in grassland production compared to the mesquite site. Ogden (1980) reported similar patterns where carbohydrate flow was higher in stems during November to March and dropped during the summer for sideoats grama, while the rain peaked during July to September.

The contrasting variations in precipitation between the 2 years observed in this study did not alter the temperature curves. EVI profiles for the two sites are more separable during the summer monsoon but tend to converge during the spring and early summer months. Precipitation plays a dominant role in evoking these differences. The arrival of precipitation during the spring, as noticed during the 2001 season, stimulated the growth of both the mesquite and grass, but the grass site had a closer relation to precipitation than the mesquite site.

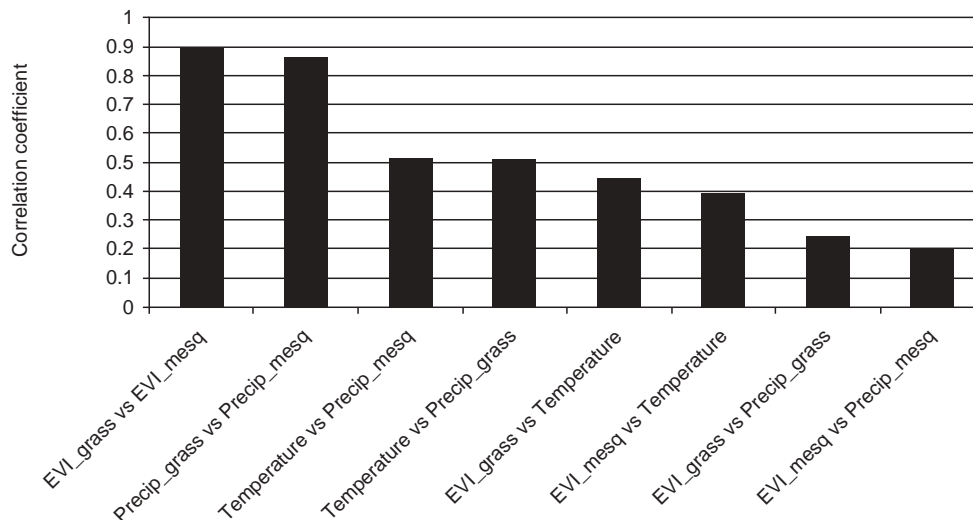

Figure 2—Relationships between enhanced Vegetation Index (EVI), Temperature, and Precipitation for the grassland and mesquite sites of the Santa Rita Experimental Range. The correlation coefficients are ranked from high to low.

Conclusion

It is evident that precipitation is the dominant attribute that controls the growth of grass in arid rangeland. However, initial growth is also possible before summer rain arrives. Mesquite growth is dependent on precipitation arrival time and amount, but responds less to precipitation variability than the grass. The ability of trees to tap into deeper soil moisture provides them with a competitive advantage and makes them less reliant on surface conditions than their grass counterparts. Warming up after a cool winter triggers new growth in rangeland vegetation. Mesquite cover responds better to seasonal temperature regimes than grass. MODIS is providing an opportunity to study the temporal dynamics of rangeland vegetation and should assist in estimating the carbon fluxes over time.

References

- Huete, Alfredo R.; Didan, Kamel; Miura, Tomoaki; Rodriguez, E. Patricia.; Gao, Xiang; Ferreira, Laerte G. 2002. Overview of the radiometric and biophysical performance of the MODIS Vegetation Indices. *Remote Sensing of Environment*. 83: 195–213.
- McClaran, Mitchel P. 1995. Desert grasslands and grasses. In: McClaran, Mitchel, P.; Van Devender, Thomas R., eds. *The desert grassland*. Tucson: University of Arizona Press: 1–30.
- McClaran, Mitchel P.; Angel, Deborah L.; Wissler, Craig. 2002. Santa Rita Experimental Range Digital Database: user's guide. Gen. Tech. Rep. RMRS-GTR-100. Ogden, UT: U.S. Department of Agriculture, Forest Service, Rocky Mountain Research Station. 13 p.
- Neilson, Ronald, P. 2003. The importance of precipitation seasonality in controlling vegetation distribution. In: Weltzin, Jake, F.; McPherson, Guy. *Changing precipitation regimes and terrestrial ecosystems: a North American perspective*. Tucson: University of Arizona Press: 45–69.
- Ogden, P. R. 1980. Meeting the physiological requirements of a plant with grazing systems. In: McDaniel, K. C.; Allison, C. *Grazing management systems for Southwest rangelands: a symposium*. Las Cruces: New Mexico State University, The Range Improvement Task Force: 37–48.
- Reeves, Matthew C.; Winslow, Jerome. C.; Running, Steven W. 2001. Mapping weekly vegetation productivity using MODIS algorithms. *Journal of Range Management*. 54: 90–105.
- Van Leeuwen, Willem. J. D.; Huete, Alfredo R.; Liang, Trevor. 1999. MODIS vegetation index compositing approach: a prototype with AVHRR data. *Remote Sensing of Environment*. 69: 264–280.
- Turner, David P.; Gower, Stith T.; Cohen Warren B.; Gregory, Mathew; Maersperger, Tom K. 2002. Effects of spatial variability in light use efficiency on satellite-based NPP monitoring. *Remote Sensing of Environment*. 80: 397–405.
- Zhang, Xiaoyang; Friedl, Mark A.; Schaaf, Crystal B.; Stahler, Alan H.; Hodges, John C. F.; Gao, Feng; Reed, Bradley C.; Huete, Alfredo. 2003. Monitoring vegetation phenology using MODIS. *Remote Sensing of Environment*. 84: 471–475.

Alessandra Fravolini
Kevin R. Hultine
Dan F. Koepke
David G. Williams

Role of Soil Texture on Mesquite Water Relations and Response to Summer Precipitation

Abstract: In the arid Southwest United States, monsoon precipitation plays a key role in ecosystem water balance and productivity. The sensitivity of deeply rooted plants to pulses of summer precipitation is, in part, controlled by the interaction between soil texture, precipitation intensity, and plant rooting depth and activity. In this study we evaluated the water relations of a leguminous tree species *Prosopis velutina* Woot. (velvet mesquite) occurring across three different aged soils varying in soil texture during two consecutive summers that substantially differed in the amount of monsoonal precipitation (1999 and 2000). We predicted that mesquite trees occurring on different textured geomorphic surfaces would be exposed to different levels of premonsoon water deficit and would not respond equally to summer precipitation. During both years, predawn and midday leaf water potentials were more negative on coarse textured soils than on medium and fine textured soils before the onset of the monsoon, indicating that plant water status is less favorable during drought on coarse-textured soils. However, leaf water potentials recovered rapidly on coarse-textured soils in response to monsoonal precipitation. These results suggest that mesquite sensitivity to future changes in winter and summer precipitation may not be uniform across the landscape, and that the interaction between precipitation and soil-plant hydraulic properties need to be better understood to realistically predict impacts of land cover change on ecosystem carbon and water balance.

Acknowledgments: The valuable help of Nathan English and Rico Gazal in reviewing this manuscript is gratefully acknowledged. Precipitation data sets were provided by the Santa Rita Experimental Range Digital Database. The study was funded by the National Science Foundation.

Introduction

According to the two-layer hypothesis, different plant life forms extract water from varying soil depths, such that deeply rooted woody plants extract water from winter precipitation that percolates deep into the soil profile while shallowly rooted grasses and herbaceous plants rely mostly on growing season precipitation (Walter 1974). However, some studies have shown a consistent overlap in water use between different functional types having different rooting depths (Lin and others 1996; Reynolds and others 1999; Schulze and others 1996; Yoder and Nowak 1999), suggesting that in a water-limited ecosystem the two layer hypothesis may be an oversimplification.

Alessandra Fravolini is a Ph.D. Candidate in the Department of Renewable Natural Resources at the University of Arizona, Tucson; e-mail: alefravo@u.arizona.edu. She completed a Laurea degree in biology with an emphasis in ecology at the University La Sapienza of Rome, Italy. Kevin R. Hultine is a Ph.D. Candidate in the Department of Renewable Natural Resources at the University of Arizona, Tucson. He completed a B.S. degree in forest resources at the University of Idaho, and an M.S. degree in the Department of Renewable Natural Resources at the University of Arizona. Dan F. Koepke is a Research Technician in the Department of Renewable Natural Resources at the University of Arizona, Tucson. He completed a B.S. degree in watershed management in the Department of Renewable Natural Resources at the University of Arizona. David G. Williams is an Associate Professor in the Departments of Renewable Resources and Botany, University of Wyoming, Director of the University of Wyoming Stable Isotope Laboratory, and Adjunct Associate Professor in the School of Renewable Resources, University of Arizona. He completed a B.A. degree in botany at the University of Texas, Austin, an M.S. degree in range science at Texas A&M University, and a Ph.D. degree in botany at Washington State University.

In: McClaran, Mitchel P.; Ffolliott, Peter F.; Edminster, Carleton B., tech. coords. Santa Rita Experimental Range: 100 years (1903 to 2003) of accomplishments and contributions; conference proceedings; 2003 October 30–November 1; Tucson, AZ. Proc. RMRS-P-30. Ogden, UT: U.S. Department of Agriculture, Forest Service, Rocky Mountain Research Station.

Changes in precipitation are likely to be the dominant factor affecting future shifts in vegetation structure and ecosystem processes in arid and semiarid regions. In southeastern Arizona, interannual variations, more than long-term variations, are typically the dominant component in the total variance of summer precipitation and are of greatest importance in terms of increasing pressures on limited resources such as water and mineral nutrients (Adams and Comrie 1997). The pattern of summer precipitation in semiarid regions is characterized by the occurrence of numerous small pulses (approximately 10 to 15 events smaller than 10 mm) and by occasional large pulses (1 to 4 events greater than 20 mm). In most arid and semiarid regions, only the large pulses significantly affect the water balance and productivity of deeply rooted plants (Noy-Meir, 1973).

Large (greater than or equal to 20 mm) but not small (less than or equal to 10 mm) summer rainfall events from two weather stations adjacent to the Santa Rita Experimental Range: Tumacacori, 31°34'N and 111°03'W (from 1980 to 2000) and Green Valley, 31°54'N and 111°00'W (from 1990 to 2000) were correlated with total summer precipitation (fig. 1). Apparently the occurrence of wet summers is generated by a few large rainfall events. From these data, we predict that the response of deeply rooted plants to

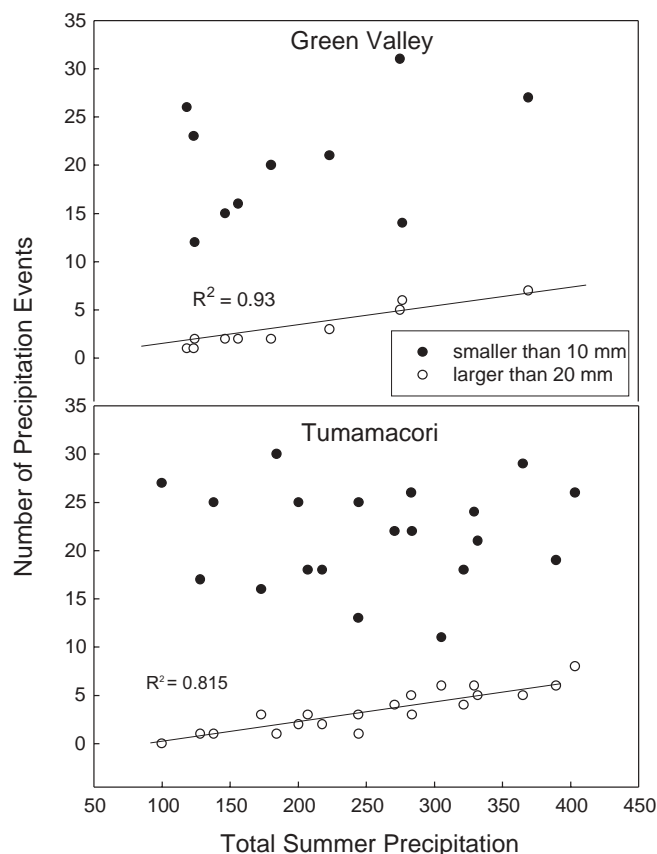

Figure 1—Correlation between total summer precipitation and numbers of events smaller than 10 mm (filled circles) or larger than 20 mm (open circles) at the Tumacacori and Green Valley weather stations in southeastern Arizona.

summer precipitation is strongly dependent on the occurrence of large rain events (more than 20 mm) that are sufficient to percolate below the rooting depth of grasses and annuals herbaceous plants.

Although patterns of precipitation are strongly linked to primary productivity in arid and semiarid regions (Eamus 2003), they cannot entirely explain vegetation dynamics without considering the influence of edaphic factors on plant water availability. Soil texture is a major factor controlling plant distribution and abundance by affecting moisture availability to plants (Bristow and others 1984; Smith and others 1995; Sperry and others 1998). For example, coarse, sandy soils lose moisture much more easily than fine textured soils because of the weaker capillary forces in the large pore spaces. Plants therefore growing in sandy soils potentially exhaust their water supplies more rapidly than plants in a finer textured soil, resulting in greater water stress, lower productivity, and more allocation of resources to the roots compared to plants in fine textured soils (Sperry and others 2002).

In this study we assessed the sensitivity of leaf water potential, a measure of plant water status, in *Prosopis velutina* Woot. (velvet mesquite) to summer precipitation across a soil texture gradient during the 1999 and 2000 growing seasons on the Santa Rita Experimental Range in Southeastern Arizona. This investigation was part of a larger study to assess the extent to which soil morphology and summer precipitation mediates the water balance and productivity of mesquite on the Santa Rita Experimental Range. Information from this study and future studies will substantially aid our ability to predict spatial and temporal patterns of woody plant encroachment and establishment in arid and semiarid rangelands.

Materials and Methods

Study Site

The study site was located on the Santa Rita Experimental Range (SRER) 35 km south of Tucson, AZ. Mean annual precipitation (average of the last 30 years) on the SRER ranges from about 250 to 500 mm, depending on elevation. Greater than 50 percent of the mean annual precipitation occurs during the summer monsoon (July to September) with high interannual variation. Mean daytime air temperature is 32 °C during summer, while mean nighttime temperature during winter is 5 °C. The plant communities on the SRER have been altered dramatically over the last 100 years by the encroachment of velvet mesquite trees into former grasslands. The geomorphology on the SRER varies from mesic sandy uplands that originated during the Holocene to clay rich Pleistocene alluvial fans (Medina 1996).

Experimental Design and Data Collection

Three sites representing young Holocene (4,000 to 8,000 ybp), late Pleistocene (75,000 to 130,000 ybp), and mid-Pleistocene (200,000 to 300,000 ybp) geomorphic surfaces were selected on the SRER. The percentage of sand, silt, and clay for each selected surface is reported in table 1. At each site, a single plot between 0.25 and 0.5 ha was established,

Table 1—Texture fractions of soils collected on Holocene, late and early Pleistocene geomorphic surfaces in the Santa Rita Experimental Range.

Surface origin	Soil depth	Sand fraction	Silt fraction	Clay fraction
	--cm--	-----percent-----		
Holocene	5	85.1	8.9	6.1
	10	85.1	7.9	7.0
	30	80.0	10.2	9.8
	60	78.7	12.4	8.9
Late Pleistocene	5	81.3	11.1	7.7
	10	77.4	12.4	10.2
	30	77.4	12.0	10.5
	60	77.4	12.4	10.2
Mid-Pleistocene	5	74.8	12.1	13.1
	10	76.1	11.2	12.7
	30	62.0	12.7	25.3
	60	45.6	15.6	38.8

and all mesquite plants were identified and placed within one of three height classes; less than 1 m, 1 to 2 m, and greater than 2 m. Three to five individuals of each size class were randomly selected at each site for leaf water potential measurement. Leaf water potential measured just before dawn yields an approximation of the soil water potential in the rooting zone, given the assumption that during the evening leaf water comes into equilibrium with soil water (Davis and Mooney 1986; Donovan and Ehleringer 1994). Midday leaf water potential is measured to gauge the minimum water potential a plant can tolerate. Predawn leaf water potential (Ψ_{pd}) was measured between 2 a.m. and 5 a.m. approximately once every 4 weeks throughout the growing seasons (May through September) of 1999 and 2000 using a Scholander-type pressure chamber (PMS Instruments, Corvallis, OR, U.S.A.). Midday leaf water potential (Ψ_{md}) was measured between 1000 and 1300 hours every 4 weeks throughout the 2000 growing season.

Statistical Analysis

Multivariate analysis for repeated measures (MANOVA) was performed on untransformed data to test the effect of geomorphic surface, precipitation, and their interaction on predawn and midday leaf water potential. In order to identify the specific differences in leaf water potential across geomorphic surfaces that were statistically meaningful, a least significant difference (LSD) contrast analysis was performed within the MANOVA framework. Results are discussed only at the highest level of significance ($P \leq 0.05$) and are reported within the result and discussion section. JMP 4 software for IBM (SAS Institute Inc.) was used to perform all statistical analysis.

Results and Discussion

Total summer precipitation on the Holocene in 1999 was 395 mm, while in 2000, total growing season precipitation was 302 mm. Precipitation data for the other two sites was

unavailable. Total monthly precipitation at the Holocene from November 1998 through September 2000 is presented in fig. 2 Winter and spring precipitation was relatively light before the 1999 and 2000 growing seasons, likely resulting in dry soil conditions before the onset of monsoonal precipitation.

There was no relationship between tree height and leaf water potential at any of the sites for either year, thus, data for all size classes were pooled. Predawn leaf water potentials differed between the 1999 and 2000 growing seasons and across geomorphic surfaces (significant year-by-surface effect $F_{3,666} = 44.44$, $P < 0.001$ from MANOVA), particularly during the early monsoon and postmonsoon periods (fig. 3a and b). Seasonal values of Ψ_{pd} were more similar between years on the mid-Pleistocene surface compared to either of the other surfaces; mean Ψ_{pd} values on the mid-Pleistocene surface ranged from near -1 to -2 MPa during both years (fig. 3a and b). Predawn water potential on the Holocene surface was lower before the 1999 and 2000 monsoon seasons, and after the 2000 monsoon than on the other two surfaces, indicating a much greater water deficit on the Holocene surface during these periods. Conversely, Ψ_{pd} was significantly higher on the Holocene and late Pleistocene surfaces relative to the mid Pleistocene during the 1999 monsoon. Mean Ψ_{pd} on the Holocene surface ranged from less than -4 MPa before both monsoon seasons to greater than -1 MPa during the 1999 monsoon and late monsoon of 2000. Early monsoon values of mean Ψ_{pd} in 2000 were significantly lower than in 1999 on the Holocene and late Pleistocene surfaces due to the lower rainfall in 2000 during the early monsoon period.

The seasonal pattern of Ψ_{md} was similar to that of Ψ_{pd} in 2000. Again, the lowest values at all sites were observed before the onset of the monsoon. Mean Ψ_{md} was lowest before and after the monsoon on the Holocene surface, followed by the late Pleistocene and mid-Pleistocene surfaces, respectively (fig. 4). The mesquite plants on the mid-Pleistocene surface showed little change in Ψ_{md} after the onset of the monsoon, and differed by less than 1 MPa throughout the year.

Pulses of monsoon precipitation can be extremely heterogeneous both spatially and temporally. We therefore can not discount the possibility that there were differences in the amount of monsoon precipitation among the three sites in a given year. However, winter precipitation is much less variable at this spatial scale such that differences in premonsoon Ψ_{pd} among the sites were likely related to differences in the hydraulic properties of the three geomorphic surfaces. As soils dry, air spreads through irregular pore spaces, and soil water potential (Ψ_s) declines causing a reduction in soil hydraulic conductivity (k_s). The lower that k_s becomes, the ability for plant roots to extract water from soil pores decreases. The relationship between Ψ_s and k_s is not constant across soil textures; coarse soils with large pore spaces have high saturated k_s , but demonstrate a much more abrupt decline in k_s with Ψ_s than finer textured soils (Jury and others 1991). The relatively sandy soil textures on the late Pleistocene and particularly on the Holocene surface suggests that plants at these sites will exhaust their water supplies much more quickly than plants on the mid-Pleistocene surface, and will become water stressed more rapidly as soils dry between precipitation pulses compared to plants

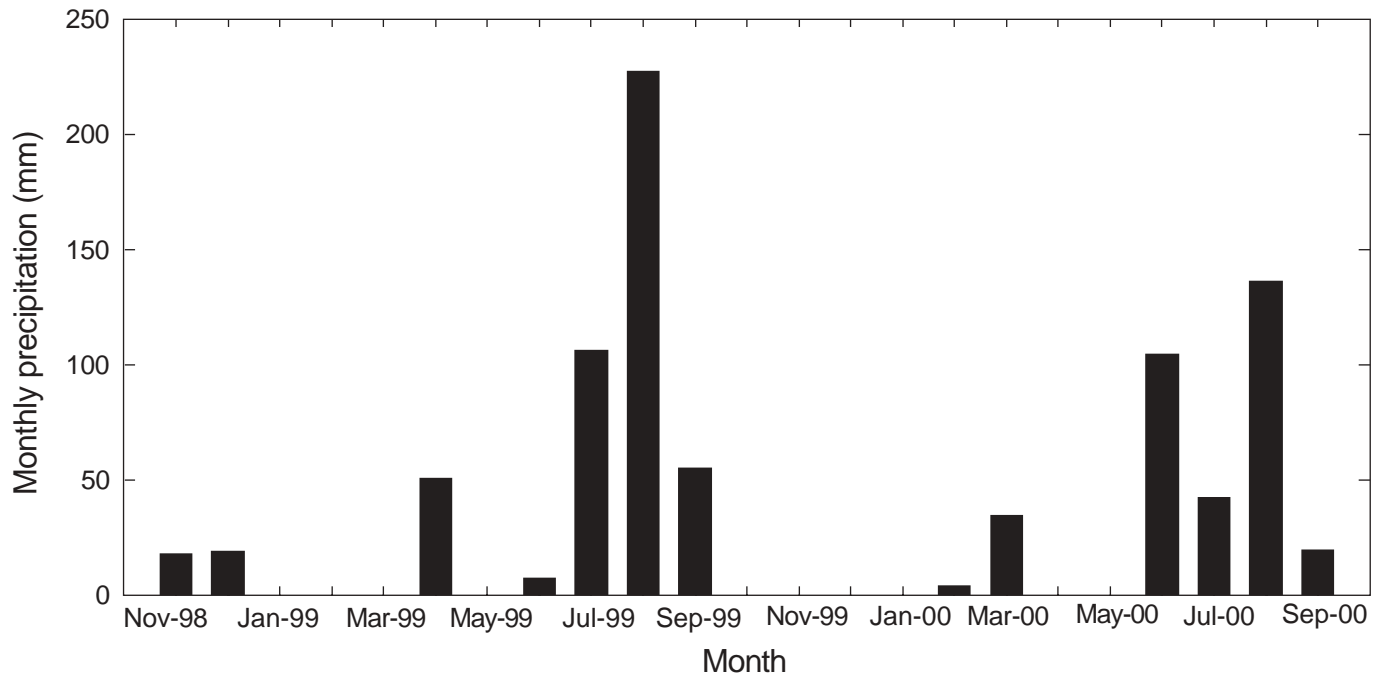

Figure 2—Total monthly precipitation measured at the Santa Rita Experimental Range between November 1998 and September 2000.

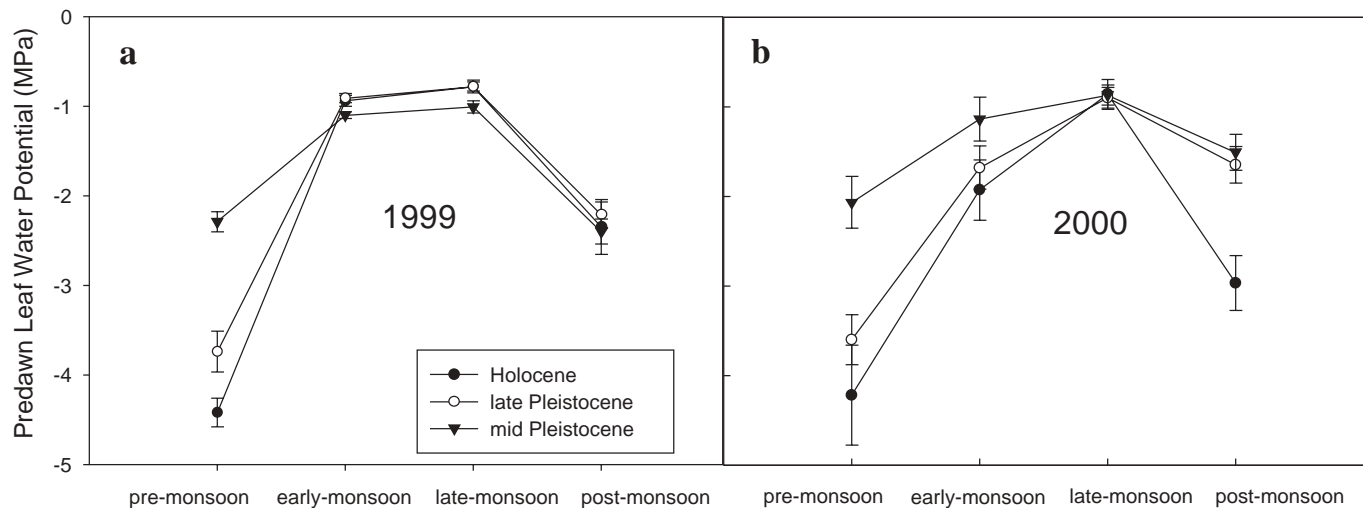

Figure 3—The time course of predawn leaf water potential Ψ_{pd} of mesquite trees across three different aged soils during the wetter monsoon season 1999 (a) and the drier 2000 (b) on the SRER. Error bars indicate \pm one standard error.

on the mid Pleistocene surface (Sperry and others 1998). On the other hand, the high k_s of coarse-textured soils may explain why Ψ_{pd} was slightly higher on the Holocene and Late Pleistocene surfaces relative to the mid-Pleistocene during the 1999 monsoon season. The above average rainfall during the 1999 monsoon likely included enough large events to saturate the soils within the rooting zone (fig. 1), thereby enhancing the water status of mesquite plants on the coarse-textured surfaces that have higher saturated

hydraulic conductivities (k_s) relative to that of the mid-Pleistocene surface. Regional climate change favoring greater precipitation would disproportionately favor the establishment and productivity of mesquite occurring on coarse-textured than on finer textured soils.

Plants in these regions must be adapted to sufficiently utilize short and infrequent pulses of growing season precipitation. During large pulse events, saturated k_s is quickly achieved in coarse-textured soils as Ψ_s approaches zero.

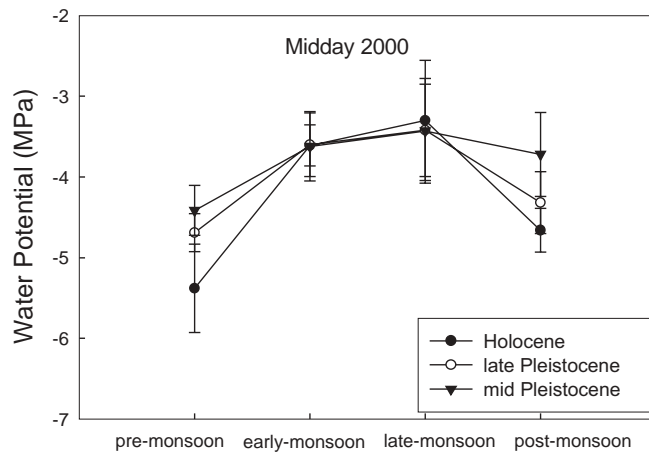

Figure 4—The time course of midday leaf water potential (Ψ_{md}) of mesquite trees measured during the 2000 (drier) monsoon season across three different aged soils in the SRER. Error bars indicate \pm one standard error.

However, as stated above, coarse-textured soils show a rapid decline in k_s with ψ_s during periods of drought. Consequently, plants occurring on coarse soils tend to optimize their utilization of short-duration pulses by increasing their root area per leaf area ratio, show a greater vertical rooting distribution, and have a greater xylem hydraulic conductance relative to plants on finer textured soils (Sperry and others 2002). Having more root area to absorb water relative to leaf area reduces the rate of water uptake, and subsequent drop in k_s in the rooting zone, thereby delaying severe plant-water deficits that quickly occur in coarse-textured soils (Hacke and others 2000). Likewise, plants in drought-stressed environments tend to develop deep root systems to forage for water in deep soil layers (Cannadell and others 1998; Jackson and others 1996). Indeed, mesquite plants at the SRER do utilize water from deeper soil layers on the Holocene than on the mid-Pleistocene surface (Fravolini, unpublished data), strongly suggesting that this species develops and maintains deeper root systems on coarser textured soils.

Leaf water potential of mesquite on the SRER shows that soil morphology likely plays a key role in plant water status and may have important consequences for patterns of growth and productivity across the SRER. Current and future work on the SRER will address the impacts of soil texture and climate on the water status, recruitment, and productivity of mesquite plants.

References

Adams, D. K.; Comrie, A. C. 1997. The North American Monsoon. *Bulletin of American Meteorological Society*. 10: 2197–2213.

- Bristow, K. L.; Campbell, G. S.; Calissendorf, C. 1984. The effects of texture on the resistance to water movement within the rhizosphere. *Journal of Soil Science Society of America*. 42: 657–659.
- Canadell, J.; Jackson, R. B.; Ehleringer, J. R.; Mooney, H. A.; Sala, O. E.; Schulze, E. D. 1996. Maximum rooting depth of vegetation types at the global scale. *Oecologia*. 108: 583–595.
- Davis, S. D.; Mooney, H. A. 1986. Water use patterns of four co-occurring shrubs. *Oecologia*. 70: 172–177.
- Donovan, L. A.; Ehleringer, J. R. 1994. Water stress and use of summer precipitation in a Great Basin shrub community. *Functional Ecology*. 8: 289–297.
- Eamus, D. 2002. How does ecosystem water balance affect net primary productivity of woody ecosystems. *Functional Plant Biology*. 30: 187–205.
- Fravolini, A. 2000. Poster presented at the 3rd international conference on applications of stable isotope techniques to ecological studies; 2002 April/May; Flagstaff, AZ.
- Hacke, U. E.; Sperry, J. S.; Ewers, B. E.; Ellsworth, D. S.; Schafer, K. V. R.; Oren, R. 2000. Influence of soil porosity on water use in *Pinus taeda*. *Oecologia*. 124: 495–505.
- Jackson, R. B.; Canadell, J.; Ehleringer, J. R.; Mooney, H. A.; Sala, O. E.; Schulze, E. D. 1996. A global review of rooting patterns: root distribution by depth for terrestrial biomes. *Oecologia*. 108: 389–411.
- Jury, W. A.; Gardner, W. R.; Gardner, W. H. 1991. *Soil physics*. New York: John Wiley and Sons.
- Lin G, Phillips; Ehleringer, J. R. 1996. Monsoonal precipitation responses of shrubs in a cold desert community on the Colorado Plateau. *Oecologia*. 125: 459–465.
- Medina A. L. 1996. The Santa Rita Experimental Range: history and annotated bibliography (1903–1988). Gen. Tech. Rep. RM-GTR-276. Fort Collins, CO: U.S. Department of Agriculture, Forest Service, Rocky Mountain Forest and Range Experiment Station.
- Noy-Meir, E. 1973. Desert ecosystems: environment and producers. *Annual Review of Ecology and Systematics*. 4: 23–51.
- Reich P. B.; Walters M. B.; Ellsworth D. S. 1997. From tropics to tundra: global convergence in plant functioning. *Proceedings of the National Academy of Sciences USA*. 94: 13730–13734.
- Reynolds, J. F.; Virginia, R. A.; Kemp, P. R.; de Soyza, A. G.; Tremmel, D. C. 1999. Impact of drought on desert shrubs: effects of seasonality and degree of resource island development. *Ecological Monographs*. 69: 69–106.
- Schulze, E. D.; Mooney, H. A.; Sala, O. E.; Jobaggy, E.; Buchmann, N.; Bauer, G.; Canadell, J.; Jackson, R. B.; Loreti, J.; Osterheld, M.; Ehleringer, J. R. 1996. Rooting depth, water availability, and vegetation cover along an aridity gradient in Patagonia. *Oecologia*. 108: 389–411.
- Smith, S. D.; Herr, C. A.; Leary, K. L.; Piorkowski, J. M. 1995. Soil plant water relations in a Mojave Desert mixed shrub community: a comparison of three geomorphic surfaces. *Journal of Arid Environments*. 29: 339–351.
- Sperry, J. S.; Alder, F. R.; Campbell, G. S.; Comstock, J. C. 1998. Limitation of plant water use by rhizosphere and xylem conductances: results from a model. *Plant, Cell and Environment*. 21: 347–359.
- Sperry, J. S.; Hacke, U. G.; Oren, R.; Comstock, J. P. 2002. Water deficits and hydraulic limits to leaf water supply. *Plant, Cell and Environment*. 25: 251–263.
- Yoder, C. K.; Nowak, R. S. 1999. Soil moisture extraction by evergreen and drought-deciduous shrubs in the Mojave Desert during wet and dry years. *Journal of Arid Environments*. 42: 81–96.
- Walter, H.; Stadelmann, E. 1974. A new approach to the water relations of desert plants. *Desert Biology*. 2: 213–310.

Stacy Pease
Peter F. Ffolliott
Leonard F. DeBano
Gerald J. Gottfried

Mesquite Removal and Mulching Treatment Impacts on Herbage Production and Selected Soil Chemical Properties

Abstract: Determining the effects of mesquite (*Prosopis velutina*) overstory removal, post-treatment control of sprouting, and mulching treatments on herbage production (standing biomass) and selected soil chemical properties on the Santa Rita Experimental Range were the objectives of this study. Mesquite control consisted of complete overstory removals with and without the control of the resulting regrowth of stump sprouts. The mulching treatments were applications of mesquite wood chips, commercial compost, and lopped-and-scattered mesquite branchwood. Herbage production was estimated in the spring and early fall to determine total annual production and the production of early growers and late growers. Mesquite removal resulted in increases in herbage production. Mesquite removal had no effect on the soil chemical properties considered. The mulching treatments did not have an affect on herbage production, although a few of the soil chemical properties were affected by some of the mulching treatments.

Keywords: mesquite removal, mulching treatments, herbage production, soil chemical properties

Acknowledgments: The authors gratefully acknowledge the reviews of this paper by William H. Kruse, USDA Forest Service (retired), Flagstaff, AZ, and George T. Robertson, USDA Forest Service, Phoenix, AZ.

Introduction

Increases in woody plants such as mesquite have been a long-time concern of rangeland managers and livestock producers in the Southwestern United States because this encroachment has often reduced herbage production and, therefore, livestock production (Heitschmidt and Dowhower 1991; Herbel and others 1983; Laxson and others 1997; Martin and Morton 1993). The encroachment of mesquite onto otherwise productive rangelands has been attributed to earlier overgrazing by livestock, reduced frequency of large-scale wildfire, changes in chemical, biological, and physical properties of the soils, and changes in climatic patterns (Herbel 1979; Martin 1975; McPherson 1997). One reason for establishment of the Santa Rita Experimental Range was to study methods of restoring depleted rangeland conditions brought about by earlier heavy livestock grazing. Among these strategies was improving rangeland conditions by controlling the invasion of mesquite.

The intent of this study was to determine the changes in herbage production (standing biomass) and selected soil chemical properties that might affect herbage production in response to mesquite removals with and without the control of the resulting regrowth of stump sprouts, the addition of mulching, or combinations thereof. Information of this kind could be incorporated into management practices to enhance the productivity of semidesert grass-shrub rangelands in the future. Preliminary results of the effects of mesquite removal and mulching treatments on herbage production were reported by Pease and others (2000).

Stacy Pease, Peter F. Ffolliott, and Leonard F. DeBano are Research Assistant and Professors, University of Arizona, Tucson. Gerald J. Gottfried is Research Forester, Rocky Mountain Research Station, USDA Forest Service, Phoenix, AZ.

In: McClaran, Mitchel P.; Ffolliott, Peter F.; Edminster, Carleton B., tech. coords. Santa Rita Experimental Range: 100 years (1903 to 2003) of accomplishments and contributions; conference proceedings; 2003 October 30–November 1; Tucson, AZ. Proc. RMRS-P-30. Ogden, UT: U.S. Department of Agriculture, Forest Service, Rocky Mountain Research Station.

Description of Study

The study area was located within the Desert Grassland Enclosure on the Santa Rita Experimental Range, an area that had not been grazed by livestock for 70 years or more. Descriptions of the climate, soils and other physiographical features, and vegetation of the Experimental Range are presented elsewhere in these proceedings. Within the study area, mesquite dominates the woody overstory, and Lehmann lovegrass (*Eragrostis lehmanniana*), an introduced species that was initially planted on the Experimental Range in 1937 (Cable 1971; Cox and Roundy 1986; Ruyle and Cox 1985), dominates the herbaceous understory vegetation. Native herbage species include *Eriogonum wrightii*, *Solanum elaeagnifolium*, and *Gnaphalium purpureum*, while common annual species are *Chenopodium album*, *Eschscholtzia mexicana*, and *Descurainia pinnata*. There are two growing seasons for the herbaceous plants. One season is early spring when temperatures and antecedent soil moisture are favorable, while the other is late summer or early autumn in response to summer rains.

Study Design and Treatments

The study design consisted of 60 5- by 5-m plots containing a mesquite tree or shrub with a minimum 1-m buffer between the plots. The plots were blocked on the basis of information from a pretreatment mesquite overstory inventory that indicated the structure and size of the mesquite tree or shrub in the plot. Treatments were then randomly assigned to the plots. The treatments, applied in early July 1995, consisted of three overstory treatments and four mulching treatments within each of the overstory treatments. Each combination of overstory treatment and mulching treatment was replicated five times. The three overstory treatments were complete removal of the mesquite overstory with and without the control of the resulting regrowth of stump sprouts by hand cutting in July 1997 and an untreated control. The mulching treatments included applications of a chip mulch, a commercial compost, lopped-and-scattered mesquite branchwood, and a control. The chip mulch, obtained from chipping the cut mesquite branchwood, was uniformly distributed on the plots to a depth of 15 to 25 mm. The commercial compost was fir based with 0.5 percent nitrogen, 0.1 percent iron, and 0.2 percent sulfur. Approximately 0.25 m³ of the compost was applied to the plots. The lopped-and-scattered mesquite branchwood was spread to completely cover the plot.

Data Collection and Analysis

Herbage production was estimated biannually (spring and fall) in May and October from 1995 through 1999 by the weight-estimate method of sampling described by Pechanec and Pickford (1937) on 0.89-m² plots. The herbage samples were dried, separated by plant species, weighted, and extrapolated to kilograms per hectare. Selected soil chemical properties were sampled annually from May 1995 through 1998. A composite of 12 subsamples was obtained from the top 5 cm of the soil on each plot. The soil samples were collected along a diagonal transect situated across the plots

with 0.3 m between the subsamples. The samples were analyzed for total nitrogen, nitrate, total organic carbon, total phosphorus, plant available phosphorus (Olsen phosphorus), and pH at the Soil, Water, Plant Analysis Laboratory of the University of Arizona, Tucson. These chemical soil properties were selected to provide the basis for a comparative analysis of a counterpart investigation in northern Israel on controlling shrub cover to increase grass productivity (Perevolotsky and others 1998).

Precipitation (mostly rainfall) was measured by a standard weighing gage located near the desert grassland enclosure. It was assumed that precipitation affecting early spring (early) growers fell from November through May, while the precipitation that fell from June through October impacted the late summer-early autumn (late) growers.

Analyses of variance were conducted to determine whether significant differences occurred in herbage production and the selected soil chemical properties among the overstory removal and/or mulching treatments. Herbage production of early growers and late growers was analyzed separately. Tukey-Kramer HSD was used to determine which treatment(s) had significantly different effects on herbage production. All statistical analyses were evaluated at a 0.10 level of significance.

Results and Discussion

Herbage Production

Total herbage production averaged 1,896 ± 115 kg per ha per year (mean ± standard error) from 1995 to 1999 on the plots receiving the two mesquite overstory treatments, and 1,554 ± 94 kg per ha per year on the control plots. The post-treatment control of resprouting did not significantly affect total herbage production. Reduced competition between mesquite and herbaceous plants for soil moisture likely contributed to the increased total herbage production on the treated plots. However, the observed increase was less than that reported in earlier studies of herbage responses to the removal of mesquite overstories (Herbel and others 1983; Heitschmidt and Dowhower 1991; Laxson and others 1997; Martin and Morton 1993).

The mesquite overstory removal treatments had no significant effect on the production of early growers, a finding that was largely attributed to the (48 percent) below-average precipitation in the period of this growing season. However, the production of late growers on the plots with mesquite removal and no post-treatment control of sprouting was greater (1,278 ± 89 kg per ha per year) than either the plots with overstory treatment and post-treatment control of sprouting or the control; the production of late growers was statistically the same (1,042 ± 69 kg per ha per year) on these latter plots. The shade provided by the resprouting mesquite might have been a causal factor for this observed increase (Shreve 1931; Tiedemann 1970).

The mulching treatments had no impact on total annual herbage production or the production of early or late growers. This result was attributed to the below average amounts of annual precipitation in the 5-year study period and, to some extent, the possibility that inadequate levels of mulch were applied to affect soil moisture availability. Biedenbender

and Roundy (1996) suggested that mulching treatments might not sufficiently affect soil moisture availability and, as a consequence, the establishment and growth of herbage plants in periods of low and infrequent rainfall.

Interaction effects between the overstory and mulching treatments on total herbage production and the production of early or late growers were all insignificant.

Soil Chemical Properties

The overstory removal treatments had no effect on the soil chemical properties evaluated. A decline in nutrient availability 13 years following the removal of mesquite on the Experimental Range was observed by Klemmedson and Tiedemann (1986). However, the duration of this current study might not have been of sufficient length to adequately reflect the impacts of mesquite removal on the soil chemical properties evaluated.

The mulching treatments had no significant effects on nitrate, total organic carbon, or total phosphorus of the soil, but these treatments did affect total nitrogen, plant available phosphorus, and pH. Total nitrogen was higher on the lopped-and-scattered plots than the control plots. The plots receiving the compost and chipped mulch had a higher pH than the control plots. There was a negative correlation between pH and plant available phosphorus on the plots with the compost and chipped mulches. These changes in soil chemical properties were small in their magnitude, however, and their impacts on herbaceous plant growth is unknown.

Conclusions

This study was conducted in a 5-year period of prolonged drought. The departures of 30 percent or more in average annual precipitation in the study period might have masked the treatment effects on annual herbage production and the selected soil chemical properties. Further investigation of the effects of mesquite removal and mulching treatments on herbage production and soil chemical properties is necessary to more completely evaluate the affects observed in this study. Nevertheless, information such as that presented in this paper can be useful to managers in attempting to enhance the productivity and stewardship of semidesert grass-shrub rangelands.

References

- Biedenbender, S. H.; Roundy, B. A. 1996. Establishment of native semidesert grasses into existing stands of *Eragrostis lehmanniana* in southern Arizona. *Restoration Ecology*. 2: 155–162.
- Cable, D. R. 1971. Lehmann lovegrass on the Santa Rita Experimental Range. *Journal of Range Management*. 24: 17–21.
- Cox, J. R.; Roundy, G. B. 1986. Influence of climatic and edaphic factors on the distribution of *Eragrostis lehmanniana* in Arizona, U.S.A. *Journal of the Grassland Society of South Africa*. 3: 25–29.
- Heitschmidt, R. K.; Dowhower, S. L. 1991. Herbage response following control of honey mesquite within single tree lysimeters. *Journal of Range Management*. 44: 144–149.
- Herbel, C. H. 1979. Utilization of grass- and shrublands of the south-western United States. In: Walker, B. H., ed. *Management of semi-arid ecosystems*. Amsterdam, The Netherlands: Elsevier Scientific Publishing Company: 161–203.
- Herbel, C. H.; Gould, W. L.; Leifeste, W. F.; Gibbens, R. P. 1983. Herbicide treatment and vegetation response to treatments of mesquites in southern New Mexico. *Journal of Range Management*. 36: 149–151.
- Klemmedson, J. O.; Tiedemann, A. R. 1986. Long-term effects of mesquite removal on soil characteristics. II. Nutrient availability. *Soil Science Society of America Journal*. 50: 476–480.
- Laxson, J. D.; Schacht, W. H.; Owens, M. K. 1997. Above-ground biomass yields at different densities of honey mesquite. *Journal of Range Management*. 50: 550–554.
- Martin, S. C. 1975. Ecology and management of Southwestern semidesert grass-shrub ranges: the status of our knowledge. Res. Pap. RM-156. Fort Collins, CO: U.S. Department of Agriculture, Forest Service, Rocky Mountain Forest and Range Experiment Station. 38 p.
- Martin, S. C.; Morton, H. L. 1993. Mesquite control increases grass density and reduces soil loss in southern Arizona. *Journal of Range Management*. 46: 170–175.
- McPherson, G. R. 1997. *Ecology and management of North American savannas*. Tucson: University of Arizona Press. 208 p.
- Pease, S.; Ffolliott, P. F.; DeBano, L. F.; Gottfried, G. J. 2000. Effects of mesquite control and mulching treatments on herbage production on semiarid shrub-grasslands. In: Ffolliott, P. F.; Baker, M. B., Jr.; Edminster, C. B.; Dillon, M. C.; Mora, K. L., tech. coords. *Land stewardship in the 21st century: the contributions of watershed management*. Proc. RMRS-P-13. Fort Collins, CO: U.S. Department of Agriculture, Forest Service, Rocky Mountain Research Station: 265–267.
- Pechanec, J. F.; Pickford, G. D. 1937. A weight estimate method for determination of range or pasture production. *Journal of the American Society of Agronomy*. 29: 894–904.
- Perevolotsky, A.; Schwartz, R.; Hadar, L.; Yonatan, R. 1998. Controlling shrub cover and increasing grass productivity in semi-arid environments. Bet Dagan, Israel: Agricultural Research Organization. 12 p.
- Ruyle, G. B.; Cox, J. 1985. Lehmann lovegrass—a naturalized citizen. *Arizona Farmer Stockman*. 51(4): 26.
- Shreve, F. 1931. Physical conditions in sun and shade. *Ecology*. 12: 96–105.
- Tiedemann, A. R. 1970. Effect of mesquite (*Prosopis juliflora*) trees on herbaceous vegetation and soils in the desert grassland. Tucson: University of Arizona. 159 p. Dissertation.

Gambel and Scaled Quail Diets on the Santa Rita Experimental Range

Abstract: Diets of Gambel (*Lophortyx gambelii* Gambel) and scaled quail (*Callipepla squamata* Vigors) from 1982 to 1984 were examined on the Santa Rita Experimental Range in southern Arizona. Quail selected some foods yearlong and others on a seasonal basis, but exhibited a preference for the seeds and leaves of forbs and insects. Seeds of bristlegrasses were selected primarily during winter. Gonadal development was strongly associated with the availability of spring forbs. Forbs were most common in areas frequented by cattle in native range pastures, and nearly absent from Lehmann lovegrass (*Eragrostis lehmanniana* Nees) habitats. Gambel quail exhibited an affinity for desert hackberry (*Celtis pallida*) as resting cover, while scaled quail were most often associated with grassland habitats with bunchgrasses. The management implications of cattle, quail, and Lehmann's lovegrass interactions are discussed.

Acknowledgments: A debt of gratitude is expressed to Robert Lee Mays, Penny Medina, Scott Medina, and Joyce Medina for contributing countless hours of volunteer work. Mr. Mays' technical expertise in plant identification and collection provided the basis for all the plant work involved in this study.

Introduction

Diets of Gambel (*Lophortyx gambelii* Gambel) and scaled quail (*Callipepla squamata* Vigors) have been described for portions of Texas (Ault and Stormer 1983; Campbell-Kissock and others 1985), Oklahoma (Schemnitz 1961), New Mexico (Best and Smartt 1985; Campbell and others 1973; Davis and Banks 1973; Davis and others 1975; Schemnitz and others 1997), Arizona (Kelso 1937), and the Santa Rita Experimental Range (Hungerford 1960). These studies were seasonal, typically only fall and winter, or were conducted in habitats different from those available to scaled quail on SRER. Continuous study of quail diets across seasons and years were first reported by Medina (1988) for scaled quail.

The objective of this research was to compare the amounts and kinds of foods consumed by Gambel and scaled quail in southern Arizona across seasons for 2 successive years. Additional information on the gonadal cycle and endoparasites was also collected. The importance of maintaining diverse plant communities as it relates to quail habitats and livestock grazing is discussed.

Study Area

The study was conducted on the Santa Rita Experimental Range (SRER) in Pima County, Arizona. The study area was described in detail by Martin and Reynolds (1973), but considerable changes in herbaceous vegetation have occurred in the last 40 years. Lehmann's lovegrass (*Eragrostis lehmanniana* Nees) was sown as a reseeding treatment in the 1950s. Spread by seed, it has become the dominant graminoid in areas of mid to high elevation (Cox and Ruyle 1986; Medina 1986). Vegetation on the range is dominated by stands of velvet mesquite (*Prosopis juliflora*), cholla cactus (*Opuntia fulgida*, *O. spinosior*, and *O. versicolor*), prickly pear cactus (*O. engelmanni*), burroweed (*Haplopappus tenuisectus*), acacia (*Acacia* spp.), and mimosa (*Mimosa* spp.). Various native grass species including three-awn (*Aristida* spp.), grama (*Bouteloua* spp.), bush muhly (*Muhlenbergia porteri*), and Arizona cottontop (*Trichachne californica*) persist (Medina 1988). Plant nomenclature follow USDA, NRCS (2002).

Alvin L. Medina is a Research Ecologist with the Rocky Mountain Research Station at the Southwest Forestry Sciences Laboratory in Flagstaff, AZ. He completed B.S. and M.S. degrees in wildlife management at New Mexico State University. He has extensive field experience in range and wildlife management, having previously worked for the Colorado Division of Wildlife, Bureau of Land Management, and USDA Forest Service.

In: McClaran, Mitchel P.; Ffolliott, Peter F.; Edminster, Carleton B., tech. coords. Santa Rita Experimental Range: 100 years (1903 to 2003) of accomplishments and contributions; conference proceedings; 2003 October 30–November 1; Tucson, AZ. Proc. RMRS-P-30. Ogden, UT: U.S. Department of Agriculture, Forest Service, Rocky Mountain Research Station.

The Santa Rita Experimental Range is situated on a broad sloping bajada interspersed by numerous dry washes. Elevations range from 885 to 1,370 m. Average rainfall ranges from 25 cm at 885 m to approximately 51 cm at 1,370 m. Precipitation for the study period 1982 to 1984 was similar to the 43-year mean. The frost-free period is approximately 8 months, but growth of herbaceous plants is limited by drought during May and June. Sixty percent of annual rainfall occurs between 1 July and 30 September (Medina 1988).

Methods

Detailed crop analyses were described in Medina (1988). Quail were collected each month with a shotgun from September 1982 through December 1984. Some quail were collected by hunters during quail hunting seasons and their attributes were noted. Individual quail were identified by sex, age, and species, and their total body weights recorded. Diets (table 1) were assessed by analysis of crop contents that were oven-dried.

Table 1—List of principal plants comprising the diets of Gambel and scaled quail on the Santa Rita Experimental Range.

Scientific name	Plant code	Scientific name	Plant code
<i>Abutilon berlandieri</i> Gray ex S. Wats.	ABBE	<i>Lotus wrightii</i> (Gray) Greene	LOWR
<i>Acacia angustissima</i> (P. Mill.) Kuntze	ACAN	<i>Lupinus sparsiflorus</i> Benth.	LUSP2
<i>Acacia constricta</i> Benth.	ACCO2	<i>Lygodesmia grandiflora</i> (Nutt.) Torr. & Gray	LYGR
<i>Acacia greggii</i> Gray	ACGR	<i>Machaeranthera tanacetifolia</i> (Kunth) Nees	MATA2
<i>Acalypha neomexicana</i> Muell.-Arg.	ACLO2	<i>Menodora scabra</i> Gray	MESC
<i>Acleisanthes longiflora</i> Gray	ACNE	<i>Mimosa dysocarpa</i> Benth.	MIDY
<i>Amsinckia douglasiana</i> A. DC.	AMDO	<i>Mollugo verticillata</i> L.	MOVE
<i>Argemone pleiacantha</i> Greene	ARPL3	<i>Monolepis nuttalliana</i> (J.A. Schultes) Greene	MONU
<i>Aristolochia watsonii</i> Woot. & Standl.	ARWA	<i>Opuntia engelmannii</i> Salm-Dyck	OPEN3
<i>Astragalus allochrous</i> Gray var. playanus Isely	ASALP	<i>Panicum capillare</i> L.	PACA6
<i>Astragalus nuttallianus</i> DC.	ASNU4	<i>Panicum hallii</i> Vasey var. hallii	PAHAH
<i>Astragalus tephrodes</i> Gray	ASTE8	<i>Panicum hirticaule</i> J. Presl	PAHI5
<i>Baileya multiradiata</i> Harvey & Gray ex Gray	BAMU	<i>Parkinsonia microphylla</i> Torr.	PAMI5
<i>Boerhavia intermedia</i> M.E. Jones	BOIN	<i>Penstemon pseudospectabilis</i> M.E. Jones	PEPS
<i>Boerhavia spicata</i> Choisy	BOSP	<i>Phaseolus ritensis</i> M.E. Jones	PHRI
<i>Calliandra eriophylla</i> Benth.	CAER	<i>Phytolacca crassifolia</i> Benth.	PHCR4
<i>Carlownrightia arizonica</i> Gray	CAAR7	<i>Plagiobothrys arizonicus</i> (Gray) Greene ex Gray	PLAR
<i>Celtis pallida</i> Torr.	CEPA8	<i>Plagiobothrys pringlei</i> Greene	PLPR3
<i>Cerastium brachypodum</i> (Engelm. ex Gray) B.L. Robins.	CEBR	<i>Polanisia dodecandra</i> (L.) DC. ssp. <i>trachysperma</i> (Torr. & Gray) Iltis	PODOT
<i>Cerastium glomeratum</i> Thuill.	CEGL2	<i>Portulaca oleracea</i> L.	POOL
<i>Cerastium nutans</i> Raf.	CENU2	<i>Portulaca pilosa</i> L.	POPI3
<i>Chamaesyce maculata</i> (L.) Small	CHMA15	<i>Proboscidea parviflora</i> (Woot.) Woot. & Standl.	PRPA2
<i>Chamaesyce melanadenia</i> (Torr.) Millsp.	CHME5	<i>Prosopis juliflora</i> (Sw.) DC.	PRJU3
<i>Chamaesyce prostrata</i> (Ait.) Small	CHPR	<i>Rumex hymenosepalus</i> Torr.	RUHY
<i>Chamaesyce serrula</i> (Engelm.) Woot. & Standl.	CHSE7	<i>Salsola tragus</i> L.	SATR12
<i>Chenopodium album</i> L.	CHAL7	<i>Salvia columbariae</i> Benth.	SACO6
<i>Croton glandulosus</i> L.	CRGL	<i>Setaria grisebachii</i> Fourn.	SEGR6
<i>Cryptantha nevadensis</i> A. Nels. & Kennedy	CRNE	<i>Setaria viridis</i> (L.) Beauv.	SEVI4
<i>Dalea aurea</i> Nutt. ex Pursh	DAAU	<i>Sida spinosa</i> L.	SISP
<i>Daucus carota</i> L.	DACA6	<i>Silene antirrhina</i> L.	SIAN2
<i>Daucus pusillus</i> Michx.	DAPU3	<i>Solanum douglasii</i> Dunal	SODO
<i>Descurainia pinnata</i> (Walt.) Britt.	DEPI	<i>Solanum heterodoxum</i> Dunal var. <i>setigeroides</i> M.D. Whalen	SOHES
<i>Digitaria sanguinalis</i> (L.) Scop.	DISA	<i>Stephanomeria spinosa</i> (Nutt.) S. Tomb	STSP6
<i>Erodium botrys</i> (Cav.) Bertol.	ERBO	<i>Talinum paniculatum</i> (Jacq.) Gaertn.	TAPA2
<i>Eschscholzia californica</i> Cham.	ESCA2	<i>Tetramerium nervosum</i> Nees	TENE
<i>Eschscholzia californica</i> Cham. ssp. <i>mexicana</i> (Greene) C. Clark	ESCAM	<i>Torilis nodosa</i> (L.) Gaertn.	TONO
<i>Euphorbia marginata</i> Pursh	EUMA8	<i>Tragopogon porrifolius</i> L.	TRPO
<i>Ferocactus wislizeni</i> (Engelm.) Britt. & Rose	FEWI	<i>Urochloa arizonica</i> (Scribn. & Merr.) O. Morrone & F. Zuloaga	URAR
<i>Galactia wrightii</i> Gray	GAWR	<i>Verbesina encelioides</i> (Cav.) Benth. & Hook. f. ex Gray	VEEN
<i>Ipomoea capillacea</i> (Kunth) G. Don	IPCA2	<i>Vicia hassei</i> S. Wats.	VIHA3
<i>Ipomoea coccinea</i> L.	IPCO3	<i>Yeatesia platystegia</i> (Torr.) Hilsenb.	YEPL
<i>Ipomoea eriocarpa</i> R. Br.	IPER	<i>Ziziphus obtusifolia</i> (Hook. ex Torr. & Gray) Gray var. <i>obtusifolia</i>	ZIOB
<i>Ipomoea plummerae</i> Gray	IPPL		
<i>Kallstroemia grandiflora</i> Torr. ex Gray	KAGR		
<i>Lotus humistratus</i> Greene	LOHU2		
<i>Lotus rigidus</i> (Benth.) Greene	LORI3		
<i>Lotus salsuginosus</i> Greene	LOSA		
<i>Lotus strigosus</i> (Nutt.) Greene var. <i>tomentellus</i> (Greene) Isely	LOST4		

Individual foods were weighed and measured volumetrically by water displacement to nearest 0.1 ml. Seed identification was facilitated by an extensive seed collection (589 species) from the area, use of manuals (Martin 1946; Martin and Barkley 1961; Musil 1963; USDA Forest Service 1974), and identification of plants germinated from seeds found in samples. Herbage and insect material were treated separately. Data were initially expressed by the aggregate volume method (Martin and others 1946) and then summarized in terms of frequency of occurrence (table 2). Results were summarized on a seasonal basis (winter = December through February, spring = March through May, summer = June through August, fall = September through November). Diets are presented as percent of occurrence across seasons and years. Simple measures of statistics were used to illustrate diet selection between quail species. Means and their standard deviations are provided to illustrate diet variability. Constancy was used as a measure of the relative occurrence of an individual food across the sample period. Foods selected in all seasons have high constancy.

Seasonal condition of quail gonads were recorded by measuring the length, width, and volume of testes. Birds were refrigerated and processed within 6 hours of collection. It is well established that testis size is proportional to testicular activity in birds. In females, the size (volume) of enlarging follicles was used as a measure of ovarian activity. Ovary and testis color were also determined. Observations of general health conditions, for example, endoparasites, were also noted.

Results

Over the 2-year period, 512 crops were analyzed: 61 adult-scaled females, 15 immature (less than 1-year-old) females, 60 adult males, and 26 immature males; 104 Gambel adult females, 46 immature, 161 adult males, and 39 immature males. Seeds of 88 plant taxa (table 1) were identified in the crops: 18 woody plants, 64 herbaceous plants, and 6 grasses. Seeds averaged the highest mean frequency of occurrence (67 percent) of all food categories followed by green herbage (6.7 percent), insects (5 percent), gravel (3.4 percent), and miscellaneous.

Forb seeds were selected with 2.7 and 4.5 times greater frequency than woody and grass seeds, respectively (table 2). Consumption of forb seeds exceeded woody plant seeds during most collection periods. Grass seeds were selected with greater frequency by both quails over forb seeds during the fall seasons, and Gambel selected them about 3 times more than scaled (table 3). Gambel quail generally selected seeds of woody plant more than scaled.

Seeds that averaged high constancy and high mean frequency across seasons included smallflowered milkvetch (*Astragalus nuttallianus*), spiny hackberry (*Celtis pallida*), spotted sandmat (*Chamaesyce maculata*), morningglory (*Ipomoea eriocarpa*), foothill deervetch (*Lotus humistratus*), lupine (*Lupinus sparsiflorus*), spiny sida (*Sida spinosa*), velvet mesquite, Grisebach's bristlegrass (*Setaria grisebachii*), and green bristlegrass (*Setaria viridis*) (table 2). Other plant seeds that averaged high constancy (greater than 87 percent) across seasons but with lower mean frequency of occurrence or lower constancy but higher mean frequency of occurrence included crested pricklypoppy

(*Argemone platyceras*), spiderling (*Boerhaavia intermedia*), lambquarters (*Chenopodium album*), Arizona carlowrightia (*Carlowrightia arizonica*), Strigose bird-foot trefoil (*Lotus strigosus*), pinnate tansymustard (*Descurainia pinnata*), carpetweed (*Mollugo verticillata*), desert penstemon (*Penstemon pseudospectabilis*), sleepy silene (*Silene antirrhina*), tetramerium (*Tetramerium nervosum*), panicum (*Panicum hirticaule*), and yellow nightshade groundcherry (*Physalis crassifolia*). Mesquite seeds were the dominant woody species selected. Morningglory seeds were selected more than any other forb. Bristlegrasses were the most important grasses yearlong.

Seasonal differences in quail diets were highly variable (table 2) for many species. Seeds of some plants (for example, *Acacia constricta*, *Tragopogon porrifolius*) became important in summer and fall, while others (for example, *Baileya multiradiata*, *Euphorbia marginata*) were more important in winter or spring. Green herbage and insects were important yearlong, and green herbage was especially important in late winter. Both green herbage and insects were represented in 67 percent of all crops across all seasons. Ants, beetles, and grasshoppers composed the bulk of insects eaten.

Differences in diets between Gambel and scaled quail were not apparent within or across seasons for individual plants, but were evident across major food groups (tables 2 and 3). Foods may or may not be selected in any one season. Individual foods with high constancy across seasons were used in relatively the similar proportions within seasons. However, some seasonal differences were evident at the group level primarily for seeds of forbs and grasses (table 3). Scaled quail selected seeds of forbs, grasses, and woody plants 1.5 to 4 times less than Gambel quail in the summer and fall. These differences were less apparent during the winter and spring.

Differences in body weights between species, sex, and age were unremarkable (table 4). Examination of seasonal body weights also were unremarkable. Differences in body weights of juveniles during the fall were noted and attributed to collection times. The body weight of juveniles collected early in the summer were less than those collected during the first month of the fall season. This was verified from examination of body weights across months for this group (table 5).

Male gonadal development initiated in early March with onset of cool season herbage (primarily *Erodium* spp.), peaked in late April to early May, remained active through mid-July, decreased in September, and slightly increased in October and November during hunting season (table 6). Teste size and color ranged from small and white-gray during periods of low activity to large and black during developmental periods. Testes began to shrink in August, attaining a stable volumetric size near 0.1 cc through the winter. Ovary development in female quail initiated about 1 month earlier than teste development in males. Eggs were laid primarily in May to June. Hatching of chicks occurred primarily in June to July, but occasional eggs and chicks were observed into August.

Nematodes were observed in 8.4 percent of all quail examined, with a 3.7 percent occurrence in Gambel and 4.7 percent in scaled quail. Tapeworms (*Gastrotaenia* spp.) were observed in 9 percent of all quail examined, with a 7 percent occurrence in Gambel and 2 percent in scaled quail.

Table 2—Frequency of food plants occurring in the diets of Gambel (G) and scaled (S) quail on the Santa Rita Experimental Range by season and study period. Constancy refers to the occurrence of individual plants across seasons over the study period by quail species; average is the mean frequency in percent across the period of study for all birds.

Plant code	Fall		Winter		Spring		Summer		Constancy		Average
	G	S	G	S	G	S	G	S	G	S	
ABBE	0.43 .60			0.88			0.13		50	50	12.86
ACAN	.17							0.53	25	25	0.35
ACCO2	.86 .09						.13	.67	50	50	.44
ACGR	.52			.88		.18	.40	.40	50	75	.48
ACLO2						.54			0	25	.54
ACNE							.27		25	0	.27
AMDO	.26						.53	.67	50	25	.49
ARPL3	.35 .26		.29		.18	.36	.40	.40	100	75	.32
ARWA	.09 .26			.29		.18			25	50	.20
ASALP								.27	0	25	.27
ASNU4	1.81 1.12		2.06	2.65	.89	1.25	1.74	.53	100	100	1.51
ASTE8	.60								25	0	.60
BAMU			.29			.18			25	25	.24
BOIN	3.37 .35		.29				3.34	.40	75	50	1.55
BOSP	.60 .26			.29		.18			25	50	.33
CAAR7	.09 .17				.36	.89		.13	50	75	.33
CAER					.72	.36	.27		50	25	.45
CEPA8	2.59 .69			.88	.54	.54	2.54	1.20	75	100	1.28
CEBR				.29					0	25	.29
CENU2	.09 .09								25	25	.09
CEGL2	.09								25	0	.09
CHAL7					1.97				25	0	1.97
CHMA15	2.94 .78		.88	.59	.18	1.25	2.40	.27	100	100	1.16
CHME5	.09								0	25	.09
CHPR	.17 .60				.18				50	25	.32
CHSE7	.09					.18			25	25	.14
CRGL							.13	.40	25	25	.26
CRNE							.13		25	0	.13
DAAU				.29					0	25	.29
DACA6				.29					0	25	.29
DAPU3						.18	.27		25	25	.22
DEPI	.09		1.77	2.06	3.58	3.04			25	75	2.11
DISA	.09								25	0	.09
ERBO							.13	.13	25	25	.13
ESCA2						.18	.40	.40	25	50	.33
ESCAM	.17				.18	.54			25	50	.30
EUMA8			.29	.59	.36	.89			50	50	.53
FEWI	.69		.29	.29		.36			50	50	.41
GAWR	.09		.59						25	25	.34
IPCA2	.09						.13		50	0	.11
IPCO3	.09						.13		50	0	.11
IPER	2.68 1.64		2.95	3.54	.54	.54	1.07		100	75	1.85
IPPL	.86							.18	25	25	.83
KAGR	.26 .35						.67	.40	50	50	.42
LOHU2	3.71 1.38		1.18	2.95	2.33	4.65	2.54	1.47	100	100	2.53
LORI3	.26 .26				.18	.18	.27	.27	75	75	.24
LOSA	.26		.59	.29	.89	1.25		.27	50	75	.59
LOST4	1.38		.88	1.18	1.07	1.79	.80	.27	100	100	.98
LOWR	.26		.29		.72	.54		.40	50	75	.44

(Con.)

Table 2—(Con.)

Plant code	Fall		Winter		Spring		Summer		Constancy		Average
	G	S	G	S	G	S	G	S	G	S	
LUSP2	2.42		1.47	.88	2.86	3.22	3.20	.67	100	100	1.93
LYGR	.69 .95 .09						1.60	.27	50	50	.73
MATA2					.18				25	0	.18
MESC	.26								25	0	.26
MIDY							.27		25	0	.27
MONU	.17		.59				.13	.27	50	50	.29
MOVE	.69					.18	1.20	.53	50	50	.65
OPEN3	.09						.27	.27	50	25	.21
PACA6	1.04 .35						2.40	.40	50	50	1.05
PAHAH					.18				25	0	.18
PAH5	1.04 .35			.59	.18	.72	1.34	.80	75	100	.72
PAMI5					.36	1.25	.13	.13	50	50	.47
PEPS	.35 .26		2.06	1.18	.18	1.07		.13	75	100	.75
PHCR4	.09 .26		.29	.29	.36	.36	.27		100	75	.27
PHRI							.13		25	0	.1
PLAR						.36			0	25	.36
PLPR3	.18 .09		.59				.13		50	50	.25
PODOT					.18		1.07		50	0	.62
POOL					.36		.27		50	0	.32
POPI3	.09 .09						1.47	.53	50	50	.54
PRJU3	4.40 1.04		6.78	1.18	3.04	2.86	4.67	1.87	100	100	3.23
PRPA2						.18			0	25	.18
RUHY	.26								0	25	.26
SACO6	.09					.18	.13		50	25	.13
SATR12			.29						25	0	.29
SEGR6	3.63 .95		.59	.59	.54	.36	3.74	.53	100	100	1.37
SEVI4	6.13 1.38			1.18	.36	.54	4.81	2.14	75	100	2.36
SIAN2	.09		.59		.18	1.25	.27		50	75	.48
SISP	4.06 1.64		2.06	2.06	1.25	2.33	2.14	1.20	100	100	2.09
SODO						.18			0	25	.18
SOHES			.29						25	0	.29
STSP6	.69								25	0	.69
TAPA2	.09		.29				.27		75	0	.22
TENE	2.07 .95		.29	.59	.54	1.07	.67	.67	100	100	.86
TONO	.17				.36	1.25		.40	50	50	.55
TRPO	.17 .43						.53	1.20	50	50	.58
URAR							.13		25	0	.13
VEEN							.13		25	0	.13
VIHA3	.43 .09							.13	50	25	.22
YEPL	.09		.29	.29				.27	50	50	.24
ZIOB	.09						.53		50	0	.31
Bone	.51 .09		.88		1.07		.80	.13	100	75	.58
Gravel	5.51 1.64		4.13	3.24	3.58	3.04	4.94	1.47	100	100	3.44
GreenVeg	7.34 2.32		14.16	7.56	7.12	6.80	6.01	2.27	100	100	6.7
Insect	5.11 2.25		5.90	5.13	6.03	7.16	5.47	3.34	100	100	5.05
DryVeg	.60 .60		1.18	1.18	1.07	.54	1.34	.80	100	100	.91
Unknown	.01 .01		.18	.29	.01	.01	.01	.01	100	100	.07
Total	73.7		55.5	44.5	44.9	55.1	69.2	30.8			

Table 3—Frequency (percent) of seeds selected as foods for quail on the Santa Rita Experimental Range by life form. The total number of plants selected by individual quail species are indicated by “N.”

Seeds	Fall		Winter		Spring		Summer	
	Gambel	Scaled	Gambel	Scaled	Gambel	Scaled	Gambel	Scaled
Foods N	58	47	34	32	39	46	56	46
Forbs total percent	29.39	12.47	18.50	17.35	19.52	29.52	28.28	12.69
Grass total percent	11.84	3.03	0.59	2.36	1.26	1.62	12.42	3.87
Woody total percent	13.39	3.89	10.02	7.35	5.20	6.45	9.88	6.27
Seed total percent	54.19	18.79	29.11	26.18	25.98	37.59	50.45	22.83

Table 4—Comparison of average body weights (g) by species, sex, and age.

Class	Gambel	Scaled
Female, juvenile	123.3 ± 42.4	123.7 ± 51.4
Female, immature	159.4 ± 21.1	175.8 ± 23.6
Female, mature	169.7 ± 17.6	173.4 ± 22.4
Male, juvenile	121.0 ± 46.8	71.2 ± 59.3
Male, immature	164.9 ± 18.9	183.0 ± 9.8
Male, mature	169.8 ± 13.7	186.7 ± 13.2

Table 5—Mean body weights (g) with standard deviations indicated of Gambel and scaled quail sampled on SRER by age class, season, and species. Sample sizes are given within parenthesis.

Season	Juvenile	Immature	Mature
Fall			
Gambel	154.9 ± 16.8 (37)	168.8 ± 11.7 (31)	169.9 ± 9.4 (40)
Scaled	152.7 ± 43.6 (11)	181.1 ± 12.9 (12)	169.2 ± 36.2 (15)
Winter			
Gambel	—	179.0 ± 7.1 (2)	172.6 ± 14.1 (45)
Scaled	—	—	178.4 ± 14.1 (32)
Spring			
Gambel	—	165.2 ± 23.4 (30)	175.3 ± 16.9 (52)
Scaled	—	185.3 ± 20.0 (20)	185.1 ± 9.6 (27)
Summer			
Gambel	93.4 ± 40.9 (42)	155.8 ± 20.4 (38)	155.9 ± 13.3 (30)
Scaled	63.4 ± 36.3 (14)	170.2 ± 13.5 (13)	184.9 ± 15.5 (21)

Table 6—Monthly progression in teste and ovary development of Gambel and scaled quail on the Santa Rita Experimental Range. Values are volume (cc) determinations.

Month	Teste	Ovary/egg
January	<0.1	0.1
February	<0.1	.7
March	.7	1.8
April	.9	1.7
May	.8	6.2
June	.5	.6
July	.5	.2
August	.2	.2
September	.1	.2
October	.2	.4
November	.3	.4
December	<0.1	.2

Discussion and Management Implications

Diets of both Gambel and scaled quail were similar to those described by Campbell and others (1973), Davis and others (1975), and Schemnitz and others (1997) in southern New Mexico, Ault and Stormer (1983) in west Texas, and Campbell-Kissock and others (1985) in southwest Texas. Similarities included high selection of seeds of forbs, bristle grass seeds, and woody plants. Selection of these species over others perhaps resulted from conspicuous size of the seeds (Davis and others 1975), high protein content (Earle and Jones 1962; Jones and Earle 1966), and abundance (Medina 1988). Differences between this study and those from other states are attributed to differences in vegetation composition, site influences, and climatic factors. Schemnitz and others (1997) found Russian thistle and snakeweed seed were highly preferred by both Gambel and scaled. Medina (1988) attributed selection of succulent foods during drier seasons is perhaps an adaptive strategy developed by scaled quail in arid environments, as was observed by Wilson and Crawford (1987). Differences in diets were most evident in the relative greater quantities of forb and woody plant seeds consumed by quail in Arizona and New Mexico than in some areas in Texas. Differences in selection of various foods by quail could also be attributed to methodology of food determination, plant species composition, availability, climatic factors, individual preferences, sample size, or sampling period (Medina 1988). Greater similarities in diets of scaled quail were found between studies with similar methodologies and sampling periods. Seasonal studies tended to amplify the relative importance of individual species or group of plants (for example, grasses).

Differences in diets between quail species could be attributed to differences in habitat selection. Scaled quail were most abundant in habitats with low perennial grass cover but high forb cover. Wash and disturbed habitats had lowest perennial plant cover, highest annual plant cover, and low effort ratios. In contrast, Lehmann's lovegrass habitats had highest perennial plant cover and lowest annual plant cover (Medina 1988). Goodwin and Hungerford (1977), Campbell and others (1973), and Campbell-Kissock and others (1985) also reported avoidance of densely vegetated habitats by scaled quail and preference for habitats that exhibited diversity in plant composition, structure, and density. Apparent differences in selection of individual foods within a season were attributed to local abundance of such foods within the home range of respective coveys.

Results of this study revealed that seeds of forb plants were consumed in higher proportions than any other food item. This suggests that habitats that exhibit diverse plant composition are selected by quail. Observations indicated that scaled quail were most abundant on habitats with low perennial grass cover and high forb cover (Medina 1988). Gambel quail were most abundant on mesquite-shrub/grassland habitats. Lehmann's lovegrass habitats were seemingly the least desirable habitat for both quail, given the high percent grass cover and low forb cover. Goodwin and Hungerford (1977), Campbell-Kissock and others (1985), and Wilson and Crawford (1987) also reported avoidance of densely vegetated habitats by scaled quail. Campbell and

others (1973), Davis and others (1975), and Campbell-Kissock and others (1985) concluded that a moderately high degree of diversity in plant composition and community structure were conditions required for optimum scaled quail habitat.

The reproductive periods of the gonadal cycle were consistent with studies by Wallmo (1956). The quiescent period of testicular activity was evident in September through February. Increase in size of testes was coincident with cool-season herbage (March), which provides vitamins and other nutrients necessary for gonadal development (Hungerford 1964). The quiescent period for ovarian activity was similar to testicular activity but marked with a general decline (table 6) as early as July (September in Texas; Wallmo 1956). A similar increase in testicular activity was noted during the hunting season (October to November). This increase could be a hormonal response to nutrient intake from green herbage produced during late warm-season growth or increased activity due to hunting.

The investigation of endoparasites on SRER's quail population were incidental to dietary and habitat studies. The information is presented here to alert managers of their incidence of occurrence. The prevalence and importance of parasitic organisms (such as nematodes and tapeworms) in southwestern quail has not been studied, rather most works have dealt with bobwhite quail in areas of Southeastern and Northeastern United States (Kocan and others 1979). Other studies have also focused on Japanese quail, a species of commercial significance. Kocan and others (1979) reported the prevalence of nematodes and cestodes in Oklahoma bobwhite quail to approximate 27 and 6 percent Statewide, respectively. Boggs and others (1990) reported an incidence of physalopterid nematodes in 5 of 64 bobwhite quail examined in Oklahoma. Heavy burdens of tapeworms may reduce the vigor of the bird, occlude the intestines, and serve as a predisposing factor for other diseases (Friend and Franson 1999). Nematode infection has been suggested as a factor that may reduce fecundity within populations as well direct chick mortality (Friend and Franson 1999).

The management implications of this work for quail populations suggest that rangelands should be managed to produce a diverse vegetative composition. It is also important to note that key staple foods were those typically known as weeds, invaders, or generally undesirable species. These species typically establish on disturbed sites. On SRER these microsites are mostly sustained by cattle grazing on upland habitats. Hence, there appears to be a positive interaction between cattle grazing and good quail habitats. No evidence exists from cattle dietary studies (Galt and others 1966; Medina, unpublished data) on SRER that competition for foods is an issue. Galt and others (1982) reported cattle diets on SRER as 67 to 97 percent grasses and 0 to 4 percent forbs. Very little dietary overlap was noted for the principal food group—forbs. Secondly, range management goals have traditionally strived to achieve excellent range conditions.

This study suggests that attainment of the latter conditions may not be desirable for sustaining quail populations. Schemnitz and others (1997) concluded that moderate live-stock grazing may be beneficial to desert quail by enhancing the variety and abundance of forb plants. Smith and others (1996) noted that sightings of scaled quail and other important game species were higher on rangelands classified as

good than on excellent. They also recommend moderate grazing practices. Livestock grazing on SRER over the past century has included various grazing designs, including the Santa Rita Grazing System, continuous, and high intensity-low duration. Here, livestock grazing could be used as a tool for maintaining low seral plant communities and quail habitat diversity.

Burning, intensive grazing, and other management practices that could provide a higher proportion of food plants and perhaps a more diverse environment in lovegrass stands are alternatives that should benefit scaled quail populations in the area (Medina 1988). Furthermore, re-seeding of native rangelands with Lehmann's lovegrass should be re-evaluated with respect to potential long-term impacts on native flora and fauna. Scaled quail were most prevalent in areas with early plant successional stages and open habitats; hence, range management efforts that promote high successional plant communities should include provisions for wildlife species associated with low seral habitats. Vegetation treatments (for example, mesquite removal, fire, grazing) on SRER have demonstrated that Gambel and scaled quail habitat can be improved (Germano 1978; McCormick 1975).

References

- Ault, S. C.; Stormer, F. A. 1983. Seasonal food selection by scaled quail in northwest Texas. *Journal Wildlife Management*. 47: 222-228.
- Best, T. L.; Smartt, R. A. 1985. Foods of scaled quail in southeastern New Mexico. *Texas Academy of Science*. 37: 155-162.
- Boggs, J. F.; Peoples, A. D.; Lochmiller, R. L.; Elangbam, C. S.; Qualls, C. W., Jr. 1990. Occurrence and pathology of phyllopterid larvae infections in bobwhite quail from western Oklahoma. *Proceedings Oklahoma Academy of Science*. 70: 29-31.
- Campbell, H.; Martin, D. K.; Ferkovich, P. E.; Harris, B. K. 1973. Effects of hunting and some other environmental factors on scaled quail in New Mexico. *Wildlife Monograph*. 34. 49 p.
- Campbell-Kissock, L.; Blankenship, L. H.; Stewart, J. W. 1985. Plant and animal foods of bobwhite and scaled quail in southwest Texas. *Southwestern Naturalist*. 30: 543-553.
- Cox, J. R.; Ruyle, G. B. 1986. Influence of climatic and edaphic factors on the distribution of *Eragrostis lehmanniana* Nees in Arizona, USA. *Journal Grassland Society of South Africa*. 3: 25-29.
- Davis, C. A.; Banks, R. L. 1973. Some food habits of scaled quail in southeastern New Mexico. *Agricultural Experiment Station Res. Rep.* 270. Las Cruces: New Mexico State University. 5 p.
- Davis, C. A.; Barkley, R. C.; Haussamen, W. C. 1975. Scaled quail foods in southeastern New Mexico. *Journal Wildlife Management*. 39: 496-502.
- Earle, F. R.; Jones, Q. 1962. Analyses of seed samples from 113 plant families. *Economic Botany*. 16: 221-250.
- Friend, M.; Franson, J. C., tech. eds. 1999. *Field manual of wildlife diseases: general field procedures and diseases of birds*. U.S. Department of the Interior, U.S. Geological Survey Information and Technology Report 1999-001. 258 p.
- Galt, H. D.; Theurer, B.; Ehrenreich, J. H.; Hale, W. H.; Martin, S. C. 1966. Botanical composition of the diet of steers grazing a desert grassland range. *Proceedings Western Section American Society Animal Science*. 17: 397-401.
- Galt, H. D.; Theurer, B.; Martin, S. C. 1982. Botanical composition of steer diets on mesquite and mesquite-free desert grassland. *Journal of Range Management*. 35(3): 320-325.
- Germano, D. J. 1978. Responses of selected wildlife to mesquite removal in desert grassland. Tucson: University of Arizona. 60 p. Thesis.
- Goodwin, J. G.; Hungerford, C. R. 1977. Habitat use by native Gambel's and scaled quail and released masked bobwhite quail in southern Arizona. Res. Pap. RM-RP-197. Fort Collins, CO: U.S. Department of Agriculture, Forest Service, Rocky Mountain Forest and Range Experiment Station. 8 p.
- Hungerford, C. R. 1960. Adaptions shown in selection of food by Gambel quail. *Condor*. 64(3): 213-219.
- Hungerford. 1964. Vitamin A and productivity in Gambel's quail. *Journal Wildlife Management*. 28(1): 141-147.
- Jones, Q.; Earle, F. R. 1966. Chemical analyses of seeds. II: Oil and protein content of 759 species. *Economic Botany*. 20: 127-155.
- Kelso, L. H. 1937. Foods of the scaled quail. *Wildlife Research and Management Leaflet BS-84*. Washington, DC: U.S. Bureau Biological Survey. 9 p.
- Kearney, T. H.; Peebles, R. H. 1951. *Arizona flora*. Berkeley, CA: University of California Press. 1032 p.
- Kocan, A. A.; Hannon, L.; Eve, J. H. 1979. Some parasitic and infectious diseases of bobwhite quail from Oklahoma. *Proceedings Oklahoma Academy Science*. 59: 20-22.
- McCormick, D. P. 1975. Effect of mesquite control on small game populations. Tucson: University of Arizona. 66 p. Thesis.
- Medina, A. L. 1988. Diets of scaled quail in southern Arizona. *Journal of Wildlife Management*. 52: 753-757.
- Martin, A. C. 1946. The comparative internal morphology of seeds. *American Midland Naturalist*. 36: 513-660.
- Martin, A. C.; Barkley, W. D. 1961. *Seed identification manual*. Berkeley: University of California Press. 221 p.
- Martin, A. C.; Gensch, R. H.; Brown, C. P. 1946. Alternative methods in upland gamebird food analysis. *Journal Wildlife Management*. 10: 8-12.
- Martin, S. C.; Reynolds, H. G. 1973. The Santa Rita Experimental Range: your facility for research of semidesert ecosystems. *Journal Arizona Academy Science*. 8: 87-99.
- Musil, A. F. 1963. Identification of crop and weed seeds. *Agric. Handb.* 219. Washington, DC: U.S. Department of Agriculture. 171 p.
- Schemnitz, S. D. 1961. Ecology of the scaled quail in the Oklahoma panhandle. *Wildlife Monograph*. 8. 47 p.
- Schemnitz, S. D.; Dye, J. L.; Cardenas, M. 1997. Fall and winter foods of scaled and Gambel's quail in southwestern New Mexico. *Agricultural Experiment Station Bull.* 777. Las Cruces: New Mexico State University. 16 p.
- Smith, G.; Holechek, J. L.; Cardenas, M. 1996. Wildlife numbers on excellent and good condition Chihuahuan Desert rangelands: an observation. *Journal of Range Management*. 49(6): 489-493.
- USDA, NRCS. 2002. The PLANTS database, version 3.5 (<http://plants.usda.gov/>). USDA Plant Data Center, Baton Rouge, LA, U.S.A.
- USDA Forest Service. 1974. *Seeds of woody plants in the United States*. Agric. Handb. 450. Washington, DC: U.S. Department of Agriculture. 883 p.
- Wallmo, O. C. 1956. Ecology of scaled quail in west Texas. *Texas Game and Fish Commission Special Rep.* W-57-R. Dallas: Texas Game and Fish. 58 p.
- Wilson, M. H.; Crawford, J. A. 1987. Habitat selection by Texas bobwhites and chestnut-bellied scaled quail in south Texas. *Journal Wildlife Management*. 51: 574-582.

Historical and Recent Flora of the Santa Rita Experimental Range

Abstract: The historical flora of the Santa Rita Experimental Range was composed from historical lists of plants collected by various investigators since 1903. Plant accessions were verified from lists of plant specimens housed at the Rocky Mountain Research Station herbarium in Flagstaff, AZ, and the Rocky Mountain National Herbarium in Laramie, WY. Recent additions (1980 to 1996) to the flora were from plant collections associated with wildlife and plant studies. This list represents the most comprehensive and current inventory of plants found on the Range.

Acknowledgments: A debt of gratitude is expressed to all scientists who contributed to this effort. A special appreciation goes to Dr. S. Clark Martin who dedicated most of his professional career (more than 55 years) and retirement to conducting and organizing research, transferring technology to ranchers, resource managers, and scientists, securing the integrity of historical data and photo records, and assisting graduate students with their research. Another special thanks to Robert Lee Mays who volunteer thousands of hours in assistance to the quail and plant studies on the Santa Rita Experimental Range. Mr. Mays collected, identified, and indexed many plant specimens for our herbariums. Additional thanks to Penny Medina, Scott Medina, and Joyce Medina who provided considerable volunteer time to assist in plant accessions and field data collection. Plant data from the Santa Rita Experimental Range Digital Database was also used to make the plant list inclusive. Funding for the digitization of these data was provided by USDA Forest Service, Rocky Mountain Research Station, and the University of Arizona.

Introduction

The Santa Rita Experimental Range (SRER), established in 1903, is the oldest experimental range in the United States. Much of our knowledge of Southwestern grassland ecosystems was derived from pioneering works on SRER (Medina 1996). The Santa Rita continues to be an important research facility, with continuance of long-term plant and wildlife studies. Plant collections from SRER include some of the oldest accessions in herbariums of the Southwest. However, there is no published listing of the historical flora of SRER.

Early ecologists and range examiners (for example, David Griffiths, John Thornber) working on SRER, made plant inventories throughout the Santa Rita Mountains, as well as compiled plant lists from individual range studies. John J. Thornber made several collections throughout the region (Thornber 1909). Griffiths (1901, 1904, 1910) spent considerable time on the SRER documenting range conditions and noting floristic conditions across seasons. Hence, the historical flora presented herein is a compilation of floristic data from many plant studies, by many investigators, over the last century. A preliminary list was initially compiled in 1906, and additions to the list were made periodically until the late 1940s. The master list was used as a guide in plant studies. This checklist was compiled in tribute to all the scientists, naturalists, and botanists who conducted research worked on SRER and in recognition of their contributions. Many of the works of these contributors are listed in Medina (1996). Additions to the historical checklist include plant collections from quail studies (Medina 1988) and new plants listed in the SRER Web site by the University of Arizona.

The Range

The Santa Rita Experimental Range consists of 53,159 acres about 35 miles south of Tucson in Pima County, Arizona. It lies at the foot of the northwestern edge of the Santa Rita Mountains. It is characterized by small areas of steep, stony foothills

Alvin L. Medina is a Research Ecologist with the Rocky Mountain Research Station at the Southwest Forestry Sciences Laboratory in Flagstaff, AZ; e-mail: almedina@fs.fed.us. He completed B.S. and M.S. degrees in wildlife management at New Mexico State University. He has extensive field experience in range and wildlife management, having previously worked for the Colorado Division of Wildlife, Bureau of Land Management, and the USDA Forest Service.

In: McClaran, Mitchel P.; Ffolliott, Peter F.; Edminster, Carleton B., tech. coords. Santa Rita Experimental Range: 100 years (1903 to 2003) of accomplishments and contributions; conference proceedings; 2003 October 30–November 1; Tucson, AZ. Proc. RMRS-P-30. Ogden, UT: U.S. Department of Agriculture, Forest Service, Rocky Mountain Research Station.

and a few isolated buttes, but the greater part consists of long, gently sloping alluvial fans. Upper fans slope rather steeply and are cut by canyons and arroyos. At lower elevations, the slope diminishes to about 100 ft per mile, and drainages become relatively shallow. Terraces, breaks, or low escarpments and numerous gullies characterize some parts of the lower range. Elevations range from 2,900 ft in the northwestern corner to about 5,200 ft in the southeastern part. Average annual rainfall increases with elevation, from 10 inches at 2,900 ft to almost 20 inches at 4,300 ft (Medina 1996).

The soils are representative of those developed under southwestern arid conditions. Most consist of, or developed from, recent alluvial deposits. Three soil orders (Aridisols, Entisols, and Mollisols) and 21 soil series have been described by Clemmons and Wheeler (1970). The soils present an interesting range of characteristics due directly or indirectly to differences in elevation and proximity to the Santa Rita Mountains. With greater elevation and proximity to the mountains, rainfall increases, temperatures decrease, soils are darker, soils have a higher content of organic matter, and soils are more deeply leached of soluble salts. Erosion is most pronounced in the lower elevations coincident with vegetation density.

Vegetation Changes

Major vegetation changes have occurred since the early 1900s. Velvet mesquite (*Prosopis juliflora* (Sw.) DC.) is the dominant overstory species on 20,000 to 30,000 acres where shrub-free grassland dominated 80 years ago. Mesquite and prickly pear cactus are major species above 4,000 ft, but other species including acacia (*Acacia greggii* Gray var. *greggii*, *Acacia angustissima* (P. Mill.) Kuntze var. *suffrutescens* (Rose) Isely), mimosa (*Mimosa aculeaticarpa* Ortega var. *biuncifera* (Benth.) Barneby, *Mimosa dysocarpa* Benth.), and falsemesquite (*Calliandra eriophylla* Benth.) comprise 65 percent of the cover in this zone compared to 21 percent below 3,000 ft. Mesquite, burroweed (*Isocoma tenuisecta* Greene), and cholla cactus (*Opuntia fulgida* Engelm., *Opuntia spinosior* (Engelm.) Toumey, and *Opuntia versicolor* Engelm. ex Coult.) attain highest densities between 3,200 and 3,600 ft elevation (Martin and Reynolds 1973). Lower elevations (less than 3,200 ft) are dominated by creosote bush (*Larrea tridentata* (Sessé & Moc. ex DC.) Coville). Lehmann's lovegrass (*Eragrostis lehmanniana* Nees), sown for experimental purposes, has expanded its distribution across thousands of acres, forming monocultures on some sites (Medina 1996). These changes in grassland types can have serious consequences on quail habitats and their foods by excluding preferred foods (Medina 1988, this proceedings).

Martin and Turner (1977) examined vegetational changes in the Sonoran Desert region and noted that numbers of some species undergo long-term (low frequency) fluctuations, while others fluctuate with higher frequencies. The activities of man are considered generally pervasive, but rodents and other wildlife may also induce and sustain changes. Pioneer wildlife work on SRER by Vorhies and Taylor (1933) illustrated that rodents and lagomorphs alone can keep range sites within a poor or fair condition. Other factors also contributed to vegetation change on SRER,

including experimentation with grazing systems (Marin 1978), fire (Martin 1983), herbicide and vegetation removal treatments, rodent and rabbit control, fertilizer applications, and water spreading (Martin 1975). Climate change is probably the most important natural factor that changed vegetation dynamics on SRER over the last century. Many studies throughout the research history of the range document the effects of rainfall and temperature on plant production, mortality, and reproduction (Martin 1975; Martin and Cable 1974).

Flora

The vascular flora of SRER contains 468 species, in 283 genera, and 80 families. Since 1984 at least 123 new additions to the flora have been indexed. The three largest families are Poaceae with 81 species, Asteraceae with 72 species, and Fabaceae with 61 species. These families account for 45 percent of the total flora. Important genera of the Poaceae family include *Bouteloua*, *Aristida*, and *Muhlenbergia*. Important genera of the Fabaceae family include *Acacia*, *Lotus*, and *Lupinus*. Several genera of the Asteraceae family contain species of unique and common value.

The author has examined all recent and historical collections forming the basis for this checklist. Voucher specimens are deposited at various herbariums, including the Rocky Mountain Herbarium and Forest Service National Herbarium in Laramie, WY, Rocky Mountain Research Station Herbarium in Flagstaff, AZ, Arizona State University Herbarium, and the University of Arizona Herbarium. Nomenclature follows USDA NRCS (2002). This checklist is intended to serve as documentation of historical and recent additions to the flora of SRER, and as a basis for future plant studies and reference.

The vascular list (table 1) is intended as documentation of the historical plants that occurred on SRER. It should serve as a basis for other comparative floristic studies of the region. While the list contains many species, many new species are yet to be indexed. The list is also a valuable guide to reference species of lesser economic importance but of ecological significance in regards to invasive plant ecology.

References

- Clemmons, S.; Wheeler, L. D. 1970. Soils report: Santa Rita Experimental Range, Coronado National Forest. Albuquerque, NM: U.S. Department of Agriculture, Forest Service, Southwestern Region. 41 p.
- Griffiths, David. 1901. Range improvement in Arizona. Bureau of Plant Industry Bull. 4. Washington, DC: U.S. Department of Agriculture. 31 p.
- Griffiths, David. 1904. Range investigations in Arizona. Bureau of Plant Industry Bull. 67 (10 plates). Washington, DC: U.S. Department of Agriculture. 62 p.
- Griffiths, David. 1910. A protected stock range in Arizona. Bull. 177. Washington, DC: U.S. Department of Agriculture. 28 p.
- Martin, S. Clark. 1975. Ecology and management of Southwestern semidesert grass-shrub ranges: the status of our knowledge. Res. Pap. RM-156. Fort Collins, CO: US Department of Agriculture, Forest Service, Rocky Mountain Forest and Range Experiment Station. 39 p.
- Martin, S. Clark. 1978. The Santa Rita Grazing System. Proceedings of First International Rangeland Congress. 1: 573-575.
- Martin, S. Clark. 1983. Responses of semidesert grasses and shrubs to fall burning. *Journal of Range Management*. 36(5): 604-610.

- Martin, S. C.; Reynolds, H. G. 1973. The Santa Rita Experimental Range: your facility for research on semidesert ecosystems. *Journal of the Arizona Academy of Science*. 8: 56–67.
- Martin, S. Clark; Reynolds, H. G. 1974. Managing semidesert grass-shrub ranges: vegetation responses to precipitation, grazing, soil texture, and mesquite control. *Tech. Bull.* 1480. Washington, DC: U.S. Department of Agriculture, Forest Service. 45 p.
- Martin, S. Clark; Turner, Raymond M. 1977. Vegetation change in the Sonoran Desert region, Arizona and Sonora. *Arizona Academy of Science*. 12(2): 59–69.
- Medina, Alvin L. 1988. Diets of scaled quail in southern Arizona. *Journal of Wildlife Management*. 52: 753–757.
- Medina, Alvin L. 1996. The Santa Rita Experimental Range: history and annotated bibliography (1903–1988). *Gen. Tech. Rep. RM-GTR-276*. Fort Collins, CO: U.S. Department of Agriculture, Forest Service, Rocky Mountain Forest and Range Experiment Station
- Thorner, John J. 1909. Vegetation groups of the Desert Laboratory domain. In: Spalding, V. M., ed. *Distribution and movements of desert plants*. Publ. 113. Washington, DC: Carnegie Institute of Washington: 103–112.
- USDA NRCS. 2002. The PLANTS database, version 3.5 (<http://plants.usda.gov/>). Baton Rouge, LA: U.S. Department of Agriculture, Plant Data Center.
- Vorhies, Charles T.; Walter P. Taylor, Watler P. 1933. The life histories and ecology of jackrabbits, *Lepus alleni* and *Lepus californicus* spp., in relation to grazing in Arizona. *Tech. Bull.* 49. Tucson: University of Arizona, Agricultural Experiment Station. 117 p.

Table 1—List of the historical and recent flora of the Santa Rita Experimental Range. Family names are in bold. The historical plant name (nonitalicized) follows the current accepted name (italicized) only when there was a name change.

Acanthaceae	<i>Ambrosia dumosa</i> (Gray) Payne ^a
<i>Anisacanthus thurberi</i> (Torr.) Gray	<i>Artemisia carruthii</i> Wood ex Carruth. ^a
<i>Carlowrightia arizonica</i> Gray	<i>Baccharis brachyphylla</i> Gray
<i>Tetramerium nervosum</i> Nees	<i>Baccharis emoryi</i> Gray
<i>Tetramerium hispidum</i> Nees.	<i>Baccharis pteronioides</i> DC.
<i>Yeatesia platystegia</i> (Torr.) Hilsenb. ^a	<i>Baccharis salicifolia</i> (Ruiz & Pavón) Pers. ^a
Agavaceae	<i>Baccharis sarothroides</i> Gray
<i>Agave palmeri</i> Engelm. ^a	<i>Baccharis thesioides</i> Kunth
<i>Yucca elata</i> (Engelm.) Engelm. ^a	<i>Baccharis wrightii</i> Gray
Aizoaceae	<i>Bahia absinthifolia</i> Benth. var. <i>dealbata</i> (Gray) Gray
<i>Trianthema portulacastrum</i> L. ^a	<i>Baileya multiradiata</i> Harvey & Gray ex Gray
Amaranthaceae	<i>Bidens bigelovii</i> Gray
<i>Amaranthus palmeri</i> S. Wats.	<i>Carphochaete bigelovii</i> Gray
<i>Gomphrena nitida</i> Rothrock	<i>Chaetopappa ericoides</i> (Torr.) Nesom ^a
<i>Gomphrena sonora</i> Torr.	<i>Cirsium arizonicum</i> (Gray) Petrak
<i>Guilleminea densa</i> (Humb. & Bonpl. ex Willd.) Moq. var. <i>Densa</i>	<i>Cirsium horridulum</i> Michx. ^a
<i>Tidestromia lanuginosa</i> (Nutt.) Standl.	<i>Cirsium neomexicanum</i> Gray ^a
Anacardiaceae	<i>Chloracantha spinosa</i> (Benth.) Nesom ^a
<i>Rhus trilobata</i> Nutt.	<i>Conyza canadensis</i> (L.) Cronq.
Apiaceae	<i>Ericameria laricifolia</i> (Gray) Shinners
<i>Bowlesia incana</i> Ruiz & Pavón	<i>Haplopappus laricifolius</i> Gray
<i>Daucus carota</i> L. ^a	<i>Ericameria nauseosa</i> (Pallas ex Pursh) Nesom & Baird ^a
<i>Daucus pusillus</i> Michx.	<i>Ericameria suffruticosa</i> (Nutt.) Nesom
<i>Spermolepis echinata</i> (Nutt. ex DC.) Heller	<i>Haplopappus suffruticosus</i> (Nutt.) Gray
<i>Torilis nodosa</i> (L.) Gaertn. ^a	<i>Erigeron concinnus</i> (Hook. & Arn.) Torr. & Gray
<i>Yabea microcarpa</i> (Hook. & Arn.) K.-Pol.	<i>Erigeron divergens</i> Torr. & Gray
<i>Caucalis microcarpa</i> Hook. & Arn.	<i>Gutierrezia arizonica</i> (Gray) M.A. Lane
Apocynaceae	<i>Greenella arizonica</i> Gray
<i>Macrosiphonia brachysiphon</i> (Torr.) Gray ^a	<i>Gutierrezia sarothrae</i> (Pursh) Britt. & Rusby ^a
Araliaceae	<i>Guardiola platyphylla</i> Gray
<i>Aralia racemosa</i> L.	<i>Heliomeris longifolia</i> (Robins. & Greenm.) Cockerell var. <i>annua</i> (M.E. Jones) Yates
Aristolochiaceae	<i>Viguiera annua</i> (M.E. Jones) Blake
<i>Aristolochia watsonii</i> Woot. & Standl.	<i>Hymenoclea monogyra</i> Torr. & Gray ex Gray
Asclepiadaceae	<i>Hymenothrix wislizeni</i> Gray
<i>Asclepias asperula</i> (Dcne.) Woods. ssp. <i>capricornu</i> (Woods.) Woods.	<i>Isocoma tenuisecta</i> Greene ^a
<i>Asclepias brachystephana</i> Engelm. ex Torr.	<i>Haplopappus tenuisectus</i> (Greene) Blake
<i>Funastrum cynanchoides</i> (Dcne.) Schlechter ^a	<i>Lasthenia californica</i> DC. ex Lindl.
Asteraceae	<i>Lasthenia chrysostoma</i> (Fisch. & C.A. Mey.) Greene
<i>Agoseris heterophylla</i> (Nutt.) Greene	<i>Layia glandulosa</i> (Hook.) Hook. & Arn.
<i>Ambrosia ambrosioides</i> (Cav.) Payne ^b	<i>Lygodesmia grandiflora</i> (Nutt.) Torr. & Gray ^a
<i>Ambrosia artemisiifolia</i> L. ^a	<i>Machaeranthera canescens</i> (Pursh) Gray ssp. <i>canescens</i> var. <i>incana</i> (Lindl.) Gray
	<i>Machaeranthera tephrodes</i> (Gray) Greene
	<i>Machaeranthera gracilis</i> (Nutt.) Shinners

(Con.)

Table 1—(Con.)

<i>Machaeranthera pinnatifida</i> (Hook.) Shinners ssp. <i>pinnatifida</i> var. <i>pinnatifida</i>	<i>Pectocarya recurvata</i> I.M. Johnston ^a
Machaeranthera pinnatifida (Hook) Shinners pinnatifida	<i>Plagiobothrys arizonicus</i> (Gray) Greene ex Gray ^a
pinnatifida Turner & Hartman	<i>Plagiobothrys pringlei</i> Greene
Haplopappus spinulosus (Pursh) DC.	Brassicaceae
<i>Machaeranthera tagetina</i> Greene	<i>Arabis perennans</i> S. Wats.
<i>Machaeranthera tanacetifolia</i> (Kunth) Nees	<i>Descurainia pinnata</i> (Walt.) Britt.
<i>Malacothrix glabrata</i> (Gray ex D.C. Eat.) Gray	Descurainia pinnata (Walt.) Britt. ssp. ochroleuca (Woot.)
Malacothrix californica (DC) glabrata Eaton	Detling
<i>Malacothrix fendleri</i> Gray	<i>Guillenia lasiophylla</i> (Hook. & Arn.) Greene
<i>Oenopsis foliosa</i> (Gray) Greene var. <i>foliosa</i> ^b	Thelypodium lasiophyllum (Hook. & Arn.) Greene
Haplopappus fremontii (Gray) Greene	<i>Lepidium lasiocarpum</i> Nutt.
<i>Parthenium incanum</i> Kunth	<i>Lepidium virginicum</i> L. var. <i>medium</i> (Greene) C.L. Hitchc.
<i>Pectis longipes</i> Gray	Lepidium medium Greene
<i>Pectis prostrata</i> Cav.	<i>Lepidium thurberi</i> Woot.
<i>Porophyllum gracile</i> Benth.	<i>Lesquerella gordonii</i> (Gray) S. Wats.
<i>Porophyllum ruderale</i> (Jacq.) Cass. ssp. <i>macrocephalum</i> (DC.) R.R. Johnson	<i>Streptanthus carinatus</i> C. Wright ex Gray ssp. <i>arizonicus</i> (S. Wats.)
<i>Pseudognaphalium macounii</i> (Greene) Kartesz, comb. nov. ined.	Kruckeberg, Rodman & Worthington
Gnaphalium decurrens Ives, non L.	Streptanthus arizonica Wats.
<i>Psilactis asteroides</i> Gray	<i>Thelypodium integrifolium</i> (Nutt.) Endl. ex Walp.
Machaeranthera asteroides (Torr.) Greene	<i>Thysanocarpus curvipes</i> Hook.
<i>Psilostrophe cooperi</i> (Gray) Greene	Thysanocarpus curvipes Hook. Var. elegans (F. & M.) Robins
<i>Rafinesquia neomexicana</i> Gray	<i>Thysanocarpus laciniatus</i> Nutt.
<i>Sanvitalia abertii</i> Gray	Thysanocarpus laciniatus Nutt. var. crenatus (Nutt.) Brewer
<i>Senecio flaccidus</i> Less. var. <i>flaccidus</i> ^a	Cactaceae
Senecio filifolius Nutt., non Berg. ^b	<i>Carnegia gigantea</i> (Engelm.) Britt. & Rose ^a
Senecio longilobus Benth. ^b	<i>Coryphantha scheeri</i> (Muehlenpfordt) L. Benson ^a
<i>Senecio riddellii</i> Torr. & Gray	<i>Ferocactus wislizeni</i> (Engelm.) Britt. & Rose ^a
<i>Stephanomeria exigua</i> Nutt.	<i>Mammillaria grahamii</i> Engelm. var. grahamii ^a
<i>Stephanomeria spinosa</i> (Nutt.) S. Tomb ^a	Mammillaria microcarpa Engelm.
<i>Stylocline micropoides</i> Gray	<i>Opuntia acanthocarpa</i> Engelm. & Bigelow ^b
<i>Symphytotrichum divaricatum</i> (Nutt.) Nesom	<i>Opuntia arbuscula</i> Engelm. ^b
Aster subulatus Michx. var. ligulatus Shinners	<i>Opuntia engelmannii</i> Salm-Dyck ^a
<i>Tagetes lemmonii</i> Gray	<i>Opuntia fulgida</i> Engelm. ^a
<i>Tagetes micrantha</i> Cav.	<i>Opuntia imbricata</i> (Haw.) DC. ^a
<i>Thelesperma megapotamicum</i> (Spreng.) Kuntze	<i>Opuntia leptocaulis</i> DC. ^b
Thelesperma gracile (Torr.) Gray	<i>Opuntia santa-rita</i> (Griffiths & Hare) Rose ^a
<i>Tragopogon porrifolius</i> L. ^a	<i>Opuntia spinosior</i> (Engelm.) Toumey ^a
<i>Trixis californica</i> Kellogg	<i>Opuntia versicolor</i> Engelm. ex Coult. ^b
<i>Uropappus lindleyi</i> (DC.) Nutt.	Campanulaceae
Microseris linearifolia (Nutt.) Schultz-Bip.	<i>Triodanis perfoliata</i> (L.) Nieuwl.
<i>Verbesina encelioides</i> (Cav.) Benth. & Hook. f. ex Gray	<i>Triodanis perfoliata</i> (L.) Nieuwl. var. <i>biflora</i> (Ruiz & Pavón) Bradley
<i>Viguiera dentata</i> (Cav.) Spreng. var. <i>lanceifolia</i> Blake	Triodanis biflora (Ruiz & Pavón) Greene
<i>Xanthium strumarium</i> L. ^a	Capparaceae
<i>Zinnia acerosa</i> (DC.) Gray	<i>Polanisia dodecandra</i> (L.) DC. ^a
Zinnia acerosa (DC.) Gray	<i>Polanisia dodecandra</i> (L.) DC. ssp. <i>trachysperma</i> (Torr. & Gray) Iltis ^a
Zinnia pumila Gray	Caprifoliaceae
<i>Zinnia grandiflora</i> Nutt.	<i>Lonicera arizonica</i> Rehd. ^a
Bignoniaceae	Caryophyllaceae
<i>Chilopsis linearis</i> (Cav.) Sweet	<i>Cerastium brachypodium</i> (Engelm. ex Gray) B.L. Robins.
Bixaceae	Cerastium brachypodium (Engelm.) Ribins
<i>Amoreuxia palmatifida</i> Moc. & Sessé ex DC.	<i>Cerastium glomeratum</i> Thuill. ^a
Amoreuxia palmatifida M. & S.	<i>Cerastium nutans</i> Raf. var.
Boraginaceae	<i>obtectum</i> Kearney & Peebles
<i>Amsinckia douglasiana</i> A. DC. ^a	<i>Silene antirrhina</i> L.
<i>Amsinckia menziesii</i> (Lehm.) A. Nels. & J.F. Macbr. var. <i>intermedia</i>	<i>Silene laciniata</i> Cav. ssp. <i>greggii</i> (Gray) C.L. Hitchc. & Maguire
(Fisch & C.A. Mey.) Ganders	Celastraceae
Amsinckia intermedia F. & M.	<i>Mortonia scabrella</i> Gray
<i>Cryptantha angustifolia</i> (Torr.) Greene	Chenopodiaceae
<i>Cryptantha barbigera</i> (Gray) Greene	<i>Atriplex canescens</i> (Pursh) Nutt.
<i>Cryptantha crassisejala</i> (Torr. & Gray) Greene	<i>Atriplex wrightii</i> S. Wats.
<i>Cryptantha nevadensis</i> A. Nels. & Kennedy ^a	<i>Chenopodium album</i> L. ^a
<i>Pectocarya heterocarpa</i> (I.M. Johnston) I.M. Johnston	

(Con.)

Table 1—(Con.)

<i>Chenopodium fremontii</i> S. Wats.	<i>Acacia constricta</i> Benth.
<i>Cycloloma atriplicifolium</i> (Spreng.) Coult. ^a	<i>Acacia filiculoides</i> (Cav.) Trelease
<i>Kochia scoparia</i> (L.) Schrad. ^a	<i>Acacia greggii</i> Gray var. <i>greggii</i>
<i>Monolepis nuttalliana</i> (J.A. Schultes) Greene	<i>Acacia greggii</i> Gray var. <i>arizonica</i> Isely
<i>Salsola kali</i> L. ^a	<i>Amorpha californica</i> Nutt.
<i>Salsola tragus</i> L. ^a	<i>Astragalus allochrous</i> Gray var. <i>playanus</i> Isely
Commelinaceae	<i>Astragalus wootonii</i> Sheldon
<i>Commelina dianthifolia</i> Delile	<i>Astragalus arizonicus</i> Gray
<i>Tradescantia occidentalis</i> (Britt.) Smyth	<i>Astragalus nothoxys</i> Gray
Convolvulaceae	<i>Astragalus nuttallianus</i> DC.
<i>Evolvulus arizonicus</i> Gray	<i>Astragalus tephrodes</i> Gray ^a
<i>Evolvulus nuttallianus</i> J.A. Schultes	<i>Caesalpinia gilliesii</i> (Hook.) Wallich ex D. Dietr.
<i>Evolvulus pilosus</i> Nutt.	<i>Caesalpinia gilliesii</i> Wall.
<i>Ipomoea capillacea</i> (Kunth) G. Don	<i>Calliandra eriophylla</i> Benth.
<i>Ipomoea muricata</i> Cav.	<i>Calliandra humilis</i> Benth.
<i>Ipomoea coccinea</i> L.	<i>Chamaecrista nictitans</i> (L.) Moench ssp. <i>nictitans</i> var. <i>leptadenia</i>
<i>Ipomoea eriocarpa</i> R. Br. ^a	(Greenm.) Gandhi & Hatch
<i>Ipomoea plummerae</i> Gray ^a	<i>Cassia leptadenia</i> Greenm.
<i>Ipomoea triloba</i> L.	<i>Crotalaria pumila</i> Ortega
<i>Ipomoea turbinata</i> Lag. ^a	<i>Dalea aurea</i> Nutt. ex Pursh ^a
Cucurbitaceae	<i>Dalea formosa</i> Torr.
<i>Citrullus lanatus</i> (Thunb.) Matsumura & Nakai var. <i>lanatus</i>	<i>Dalea grayi</i> (Vail) L.O. Williams
<i>Citrullus vulgaris</i> Schrad.	<i>Dalea pogonathera</i> Gray
<i>Cucurbita digitata</i> Gray	<i>Dalea wrightii</i> Gray
<i>Cucurbita foetidissima</i> Kunth ^a	<i>Desmanthus cooleyi</i> (Eat.) Trel.
<i>Cyclanthera dissecta</i> (Torr. & Gray) Arn.	<i>Desmanthus jamesii</i> Torr. & Gray
<i>Marah gilensis</i> Greene	<i>Desmanthus virgatus</i> (L.) Willd. ^a
Cupressaceae	<i>Desmodium neomexicanum</i> Gray
<i>Juniperus deppeana</i> Steud.	<i>Desmodium psilocarpum</i> Gray
<i>Juniperus deppeana</i> Steud. <i>pachyphlaea</i>	<i>Eysenhardtia polystachya</i> (Ortega) Sarg.
Cuscutaceae	<i>Galactia wrightii</i> Gray
<i>Cuscuta cephalanthi</i> Engelm.	<i>Hoffmannseggia glauca</i> (Ortega) Eifert
Cyperaceae	<i>Lathyrus lanszwertii</i> Kellogg var. <i>leucanthus</i> (Rydb.) Dorn
<i>Cyperus squarrosus</i> L.	<i>Lathyrus arizonicus</i> Britt.
<i>Cyperus aristatus</i> Rottb.	<i>Lathyrus graminifolius</i> (S. Wats.) White
<i>Cyperus hermaphroditus</i> (Jacq.) Standl.	<i>Lotus greenei</i> Ottley ex Kearney & Peebles
Ephedraceae	<i>Lotus greenei</i> (Woot. & Standl.) Oettle
<i>Ephedra trifurca</i> Torr. ex S. Wats.	<i>Lotus humistratus</i> Greene
Ericaceae	<i>Lotus rigidus</i> (Benth.) Greene ^a
<i>Arbutus arizonica</i> (Gray) Sarg.	<i>Lotus salsuginosus</i> Greene ^a
<i>Arctostaphylos pungens</i> Kunth	<i>Lotus strigosus</i> (Nutt.) Greene var. <i>tomentellus</i> (Greene) Isely ^a
Euphorbiaceae	<i>Lotus unifoliolatus</i> (Hook.) Benth. var. <i>unifoliolatus</i> ^a
<i>Acalypha neomexicana</i> Muell.-Arg.	<i>Lotus wrightii</i> (Gray) Greene ^a
<i>Argythamnia neomexicana</i> Muell.-Arg. ^a	<i>Lupinus arizonicus</i> (S. Wats.) S. Wats. ^a
<i>Ditaxis neomexicana</i> (Muell.-Arg.) Heller	<i>Lupinus concinnus</i> J.G. Agardh
<i>Chamaesyce albomarginata</i> (Torr. & Gray) Small	<i>Lupinus neomexicanus</i> Greene
<i>Euphorbia albomarginata</i> Torr. & Gray	<i>Lupinus palmeri</i> S. Wats.
<i>Chamaesyce florida</i> (Engelm.) Millsp.	<i>Lupinus sparsiflorus</i> Benth.
<i>Euphorbia florida</i> Engelm.	<i>Melilotus indica</i> (L.) All.
<i>Chamaesyce maculata</i> (L.) Small ^a	<i>Mimosa aculeaticarpa</i> Ortega var. <i>biuncifera</i> (Benth.) Barneby
<i>Chamaesyce melanadenia</i> (Torr.) Millsp. ^a	<i>Mimosa biuncifera</i> (Benth.) Britt. & Rose
<i>Chamaesyce nutans</i> (Lag.) Small ^a	<i>Mimosa dysocarpa</i> Benth.
<i>Chamaesyce prostrata</i> (Ait.) Small ^a	<i>Olneya tesota</i> Gray ^a
<i>Chamaesyce serrula</i> (Engelm.) Woot. & Standl.	<i>Parkinsonia florida</i> (Benth. ex Gray) S. Wats. ^b
<i>Euphorbia serrula</i> Engelm.	<i>Parkinsonia microphylla</i> Torr. ^a
<i>Croton glandulosus</i> L. ^a	<i>Phaseolus acutifolius</i> Gray var. <i>tenuifolius</i> Gray
<i>Croton pottsii</i> (Klotzsch) Muell.-Arg. var. <i>pottsii</i>	<i>Phaseolus angustissimus</i> Gray
<i>Croton corymbulosus</i> Engelm.	<i>Phaseolus maculatus</i> Scheele
<i>Euphorbia marginata</i> Pursh ^a	<i>Phaseolus metcalfei</i> Woot. & Standl.
Fabaceae	<i>Phaseolus ritensis</i> M.E. Jones ^a
<i>Acacia angustissima</i> (P. Mill.) Kuntze var. <i>suffrutescens</i> (Rose) Isely	<i>Prosopis juliflora</i> (Sw.) DC. ^a
	<i>Prosopis velutina</i> Woot.
	<i>Senna covesii</i> (Gray) Irwin & Barneby
	<i>Cassia covesii</i> Gray
	<i>Cassia leptadenia</i> Greenm.

(Con.)

Table 1—(Con.)

<i>Senna hirsuta</i> (L.) Irwin & Barneby var. <i>glaberrima</i> (M.E. Jones) Irwin & Barneby Cassia leptocarpa Benth. var. <i>glaberrima</i> M.E. Jones <i>Tephrosia leiocarpa</i> Gray <i>Tephrosia thurberi</i> (Rydb.) C.E. Wood <i>Vicia hassei</i> S. Wats. ^a <i>Vicia leucophaea</i> Greene <i>Vicia ludoviciana</i> Nutt. ssp. <i>Ludoviciana</i> <i>Vicia exigua</i> Nutt.	Loasaceae <i>Mentzelia</i> <i>rusbyi</i> Woot. <i>Mentzelia texana</i> Urban & Gilg
Fagaceae <i>Quercus emoryi</i> Torr. <i>Quercus hypoleucoides</i> A. Camus <i>Quercus oblongifolia</i> Torr. <i>Quercus pauciloba</i> Rydb. (pro sp.) [<i>gambelii</i> x <i>turbinella</i>] <i>Quercus undulata</i> Torr. <i>Quercus rugosa</i> N.E. <i>Quercus turbinella</i> Greene	Malvaceae <i>Abutilon berlandieri</i> Gray ex S. Wats. ^a <i>Anoda cristata</i> (L.) Schlecht. Anoda lavaterioides Medik. <i>Gossypium thurberi</i> Todaro <i>Hibiscus coulteri</i> Harvey ex Gray Hibiscus coulteri Harv. <i>Sida abutifolia</i> P. Mill. Sida filicaulis Torr. & Gray Sida procumbens Sw. <i>Sida spinosa</i> L. ^a <i>Sphaeralcea emoryi</i> Torr. ex Gray Sphaeralcea emoryi Torr. <i>Sphaeralcea fendleri</i> Gray
Fouquieriaceae <i>Fouquieria splendens</i> Engelm. ^a	Molluginaceae <i>Mollugo verticillata</i> L.
Fumariaceae <i>Corydalis aurea</i> Willd.	Moraceae <i>Morus microphylla</i> Buckl.
Geraniaceae <i>Erodium botrys</i> (Cav.) Bertol. ^a <i>Erodium cicutarium</i> (L.) L'HER. ex Ait. Erodium cicutarium (L.) L'Her. <i>Erodium texanum</i> Gray	Nyctaginaceae <i>Abronia villosa</i> S. Wats. <i>Acleisanthes longiflora</i> Gray ^a <i>Allionia incarnata</i> L. <i>Boerhavia coulteri</i> (Hook. f.) S. Wats. <i>Boerhavia erecta</i> L. <i>Boerhavia intermedia</i> M.E. Jones ^a <i>Boerhavia purpurascens</i> Gray <i>Boerhavia spicata</i> Choisy ^a Boerhavia torreyana (S. Wats.) Standl. <i>Mirabilis coccinea</i> (Torr.) Benth. & Hook. f. Oxybaphus coccineus Torr. <i>Mirabilis linearis</i> (Pursh) Heimerl Oxybaphus linearis (Pursh) B.L. Robins. <i>Mirabilis longiflora</i> L. var. <i>wrightiana</i> (Gray ex Britt. & Kearney) Kearney & Peebles Mirabilis longiflora L. var. <i>wrightiana</i> (Gray) Kearney & Peebles
Hydrophyllaceae <i>Phacelia alba</i> Rydb. <i>Phacelia arizonica</i> Gray <i>Phacelia crenulata</i> Torr. ex S. Wats. <i>Phacelia distans</i> Benth. Phacelia distans Benth. Var. <i>australis</i> Brand. <i>Pholistoma auritum</i> (Lindl.) Lilja var. <i>arizonicum</i> (M.E. Jones) Constance	Oleaceae <i>Menodora scabra</i> Gray Menodora scabra Gray var. <i>ramosissima</i> Steyerem.
Juglandaceae <i>Juglans major</i> (Torr.) Heller	Onagraceae <i>Camissonia chamaenerioides</i> (Gray) Raven Oenothera chamaenerioides Gray <i>Camissonia scapoidea</i> (Nutt. ex Torr. & Gray) Raven ssp. <i>Scapoidea</i> <i>Epilobium canum</i> (Greene) Raven ssp. <i>latifolium</i> (Hook.) Raven Zauschneria californica K. Presl ssp. <i>latifolia</i> (Hook.) Keck <i>Oenothera primiveris</i> Gray
Krameriaceae <i>Krameria erecta</i> Willd. ex J.A. Schultes Krameria parvifolia Benth. var. <i>glandulosa</i> (Rose & Painter) J.F. Macbr.	Oxalidaceae <i>Oxalis albicans</i> Kunth <i>Oxalis drummondii</i> Gray Oxalis amplifolia (Trel.) Kunth.
Lamiaceae <i>Agastache wrightii</i> (Greenm.) Woot. & Standl. <i>Hedeoma dentata</i> Torr. <i>Hedeoma drummondii</i> Benth. ^a <i>Marrubium vulgare</i> L. <i>Salvia columbariae</i> Benth. <i>Salvia subincisa</i> Benth. <i>Stachys coccinea</i> Ortega <i>Trichostema arizonicum</i> Gray	Papaveraceae <i>Argemone hispida</i> Gray Argemone platyceras Link & Otto var. <i>hispida</i> (Gray) Prain <i>Argemone pleiacantha</i> Greene ^a <i>Argemone polyanthemus</i> (Fedde) G.B. Ownbey Argemone intermedia auct. non Sweet <i>Eschscholzia californica</i> Cham. ssp. <i>mexicana</i> (Greene) C. Clark Eschscholtzia mexicana Greene
Liliaceae <i>Allium cernuum</i> Roth var. <i>neomexicanum</i> (Rydb.) J.F. Macbr. <i>Allium kunthii</i> G. Don Allium scaposum (Benth.) <i>Calochortus gunnisonii</i> S. Wats. <i>Dasyllirion wheeleri</i> S. Wats. ^a <i>Dichelostemma capitatum</i> (Benth.) Wood ssp. <i>pauciflorum</i> (Torr.) G. Keator Dichelostemma pulchellum (Salisb.) Heller var. <i>pauciflorum</i> (Torr.) Hoover <i>Linum puberulum</i> (Engelm.) Heller <i>Milla biflora</i> Cav.	

(Con.)

Table 1—(Con.)

Pedaliaceae*Proboscidea parviflora* (Woot.) Woot. & Standl.**Phytolaccaceae***Rivina humilis* L.*Rivina portulacoides* Nutt.**Plantaginaceae***Plantago ovata* Forsk.^a*Plantago insularis* Eastw.*Plantago patagonica* Jacq.*Plantago purshii* R.&S.*Plantago purshii* R.&S. *picta* (Morris) Pilger*Plantago tweedyi* Gray*Plantago virginica* L.**Poaceae***Achnatherum hymenoides* (Roemer & J.A. Schultes) Barkworth^a*Aegopogon tenellus* (DC.) Trin.*Alopecurus carolinianus* Walt.*Bothriochloa saccharoides* (Sw.) Rydb.*Andropogon saccharoides* Sw.*Aristida adscensionis* L.*Aristida californica* Thurb. ex S. Wats.*Aristida californica* Thurb. ex S. Wats. var. *glabrata* Vasey^a*Aristida glabrata* (Vasey) A.S. Hitchc.*Aristida divaricata* Humb. & Bonpl. ex Willd.*Aristida purpurea* Nutt.*Aristida purpurea* Nutt. var. *fendleriana* (Steud.) Vasey*Aristida fendleriana* Steud.*Aristida ternipes* Cav.*Aristida hamulosa* Henr.*Bothriochloa barbinodis* (Lag.) Herter^a*Andropogon barbinodis* Lag.*Bouteloua aristidoides* (Kunth) Griseb.*Bouteloua barbata* Lag.*Bouteloua chondrosioides* (Kunth) Benth. ex S. Wats.*Bouteloua chondrosioides* (H.B.K.) Benth*Bouteloua**curtipendula* (Michx.) Torr.*Bouteloua eludens* Griffiths*Bouteloua eriopoda* (Torr.) Torr.*Bouteloua gracilis* (Willd. ex Kunth) Lag. ex Griffiths*Bouteloua hirsuta* Lag.*Bouteloua parryi* (Fourn.) Griffiths*Bouteloua radicata* (Fourn.) Griffiths*Bouteloua repens* (Kunth) Scribn. & Merr.*Bouteloua rothrockii* Vasey*Bromus catharticus* Vahl*Bromus willdenowii* Kunth*Bromus porteri* (Coul.) Nash*Cenchrus spinifex* Cav.*Cenchrus insertus* M.A. Curtis*Chloris virgata* Sw.*Cottea pappophoroides* Kunth^a*Dasyochloa pulchella* (Kunth) Willd. ex Rydb.*Tridens pulchellus* (Kunth) A.S. Hitchc.*Digitaria californica* (Benth.) Henr.*Trichachne californica* (Benth.) Chase*Digitaria ciliaris* (Retz.) Koel.^a*Digitaria cognata* (J.A. Schultes) Pilger var. *cognata*^b*Leptoloma cognatum* (J.A. Schultes) Chase*Digitaria sanguinalis* (L.) Scop.^a*Echinochloa acuminata* (J. Presl) Kunth var. *acuminata*^a*Eriochloa gracilis* (Fourn.) A.S. Hitchc.*Echinochloa crus-galli* (L.) Beauv.^a*Elionurus barbiculmis* Hack.*Elymus elymoides* (Raf.) Swezey*Sitanion hystrix* (Nutt.) J.G. Sm.*Enneapogon desvauxii* Desv. ex Beauv.^a*Eragrostis cilianensis* (All.) Vign. ex Janchen*Eragrostis cilianensis* (All.) Mohser*Eragrostis curvula* (Schr.) Nees^a*Eragrostis chloromelas* Steud.*Eragrostis curvula* (Schr.) Nees var. *conferta* Stapf*Eragrostis intermedia* A.S. Hitchc.^a*Eragrostis lehmanniana* Nees^a*Eragrostis superba* Peyr.^a*Heteropogon contortus* (L.) Beauv. ex Roemer & J.A. Schultes^a*Hilaria belangeri* (Steud.) Nash*Koeleria macrantha* (Ledeb.) J.A. Schultes*Koeleria pyramidata* auct. p.p. non (Lam.) Beauv.*Leptochloa dubia* (Kunth) Nees*Lycurus phleoides* Kunth*Muhlenbergia arizonica* Scribn.*Muhlenbergia emersleyi* Vasey^a*Muhlenbergia polycaulis* Scribn.*Muhlenbergia porteri* Scribn. Ex*Muhlenbergia repens* (J. Presl) A.S. Hitchc.*Muhlenbergia rigida* (Kunth) Trin.*Muhlenbergia tenuifolia* (Kunth) Trin.*Muhlenbergia monticola* Buckl.*Panicum bulbosum* Kunth*Panicum plenum* Hitchc. & Chase*Panicum capillare* L.^a*Panicum hallii* Vasey var. *hallii*^a*Panicum hirticaule* J. Presl*Panicum obtusum* Kunth*Pappophorum vaginatum* Buckl.*Piptochaetium fimbriatum* (Kunth) A.S. Hitchc.*Poa bigelovii* Vasey & Scribn.*Poa fendleriana* (Steud.) Vasey*Polypogon viridis* (Gouan) Breistr.*Agrostis semiverticillata* (Forsk.) C. Chr.*Schizachyrium cirratum* (Hack.) Woot. & Standl.*Schizachyrium scoparium* (Michx.) Nash^b*Setaria grisebachii* Fourn.*Setaria viridis* (L.) Beauv.^a*Setaria vulpiseta* (Lam.) Roemer & J.A. Schultes*Setaria macrostachya* H.B.K.*Sorghum halepense* (L.) Pers.^a*Sporobolus airoides* (Torr.) Torr.*Sporobolus airoides* Torr.*Sporobolus contractus* A.S. Hitchc.*Sporobolus cryptandrus* (Torr.) Gray^a*Sporobolus wrightii* Munro ex Scribn.*Trachypogon spicatus* (L.) Kuntze*Trachypogon secundus* (J. Presl) Scribn.*Tragus berteronianus* J.A. Schultes*Tridens muticus* (Torr.) Nash*Urochloa arizonica* (Scribn. & Merr.) O. Morrone & F. Zuloaga*Panicum arizonicum* Scribn. & Merr.*Vulpia octoflora* (Walt.) Rydb. var. *hirtella* (Piper) Henr.*Festuca octoflora* Walt. ssp. *hirtella* Piper**Polemoniaceae***Gilia filiformis* Parry ex Gray*Gilia filiformis* Parry*Gilia leptomeria* Gray*Gilia rigidula* Benth.^a*Gilia sinuata* Dougl. ex Benth.*Gilia sinuata* Dougl.

(Con.)

Table 1—(Con.)

Ipomopsis longiflora (Torr.) V. Grant
Linanthus aureus (Nutt.) Greene

Polygalaceae

Eriogonum abertianum Torr.
Eriogonum thurberi Torr.
Eriogonum wrightii Torr. Ex
Polygala alba Nutt.
Rumex hymenosepalus Torr.

Portulacaceae

Calandrinia ciliata (Ruiz & Pavón) DC.^a
Cistanthe monandra (Nutt.) Hershkovitz
 Calyptidium monandrum Nutt.
Portulaca oleracea L.^a
Portulaca pilosa L.
Portulaca umbraticola Kunth
Talinum aurantiacum Engelm.
Talinum paniculatum (Jacq.) Gaertn.

Primulaceae

Androsace occidentalis Pursh

Pteridaceae

Astrolepis sinuata (Lag. ex Sw.) Benham & Windham ssp. *Sinuata*
 Notholaena sinuata (Lag. ex Sw.) Kaulfuss

Ranunculaceae

Anemone tuberosa Rydb.
Aquilegia chrysantha Gray
Clematis ligusticifolia Nutt.
Delphinium scaposum Greene

Rhamnaceae

Frangula californica (Eschsch.) Gray ssp. *ursina* (Greene) Kartesz
 & Gandhi
 Rhamnus californica Eschsch. ssp. *ursina* (Greene) C.B. Wolf
Zizyphus obtusifolia (Hook. ex Torr. & Gray) Gray
 Zizyphus obtusifolia (Hook. ex Torr. & Gray) var. *canescens*
 (Gray) M.C. Johnst.

Rosaceae

Cercocarpus montanus Raf. var. *glaber* (S. Wats.) F.L. Martin
 Cercocarpus betuloides Nutt.
Potentilla wheeleri S. Wats.
 Potentilla viscidula Rydb.
Prunus serotina Ehrh. var. *virgens* (Woot. & Standl.) McVaugh
Purshia stansburiana (Torr.) Henrickson
 Cowania mexicana D. Don var. *stansburiana* (Torr.) Jepson

Rubiaceae

Bouvardia ternifolia (Cav.) Schlecht.
 Bouvardia glaberrima Engelm.
Diodia teres Walt. var. *angustata* Gray
Galium aparine L.
Galium microphyllum Gray
Houstonia rubra Cav.
 Hedyotis rubra (Cav.) Gray
Mitracarpus breviflorus Gray

Sapindaceae

Sapindus saponaria L. var. *drummondii* (Hook. & Arn.) L. Benson

Saxifragaceae

Heuchera sanguinea Engelm.

Scrophulariaceae

Castilleja exserta (Heller) Chuang & Heckard ssp. *exserta*
 Orthocarpus purpurascens Benth. var. *palmeri* Gray
Castilleja integra Gray
Castilleja patriotica Fern.
Mimulus guttatus DC.
Nuttallanthus texanus (Scheele) D.A. Sutton
 Linaria texana Scheele
Penstemon barbatus (Cav.) Roth
Penstemon linarioides Gray
Penstemon pseudospectabilis M.E. Jones^a

Solanaceae

Chamaesaracha coniodes (Moric. ex Dunal) Britt.^a
Datura wrightii Regel
 Datura meteloides DC
Lycium torreyi Gray
Margaranthus solanaceus Schlecht.
Nicotiana obtusifolia Mertens & Galeotti var. *Obtusifolia*
 Nicotiana trigonophylla Dunal
Physalis crassifolia Benth.
Physalis hederifolia Gray var. *fendleri* (Gray) Cronq.^a
Solanum adscendens Sendtner
 Solanum deflexum Greenm.
Solanum douglasii Dunal
Solanum elaeagnifolium Cav.
Solanum heterodoxum Dunal var. *setigeroides* M.D. Whalen^a

Sterculiaceae

Ayenia insulicola Cristobal^a

Ulmaceae

Celtis laevigata Willd.
 Celtis reticulata Torr.
Celtis pallida Torr.

Urticaceae

Parietaria hespera Hinton

Verbenaceae

Aloysia wrightii Heller ex Abrams
 Aloysia wrightii (Grey) Heller
Glandularia wrightii (Gray) Umber
 Verbena wrightii Gray
Glandularia bipinnatifida (Nutt.) Nutt. var. *bipinnatifida*
 Verbena ambrosiifolia Rydb. ex Small
Tetradlea coulteri Gray
Verbena neomexicana (Gray) Small
Verbena stricta Vent.^a

Violaceae

Viola nephrophylla Greene

Viscaceae

Phoradendron californicum Nutt.^a

Vitaceae

Vitis arizonica Engelm.

Zygophyllaceae

Kallstroemia grandiflora Torr. ex Gray
 Kallstroemia grandiflora Torr.
Larrea tridentata (Sessé & Moc. ex DC.) Coville
 Larrea tridentata (DC) Coville
Tribulus terrestris L.

^aRecent additions (1984 to 1996) by A. Medina and R. Mays.

^bAdditions from the University of Arizona Web list.

Sharon H. Biedenbender
Mitchel P. McClaran
Bruce A. Roundy

Effects of Neighbor Species and Distance on 2- and 4-Year Survival of Lehmann Lovegrass and Native Grasses

Abstract: The relationship between Lehmann lovegrass, an invasive African grass, and native Southwestern grasses has not been fully determined. The first purpose of this study was to compare the survival of Lehmann lovegrass with two native grasses (plains lovegrass and Arizona cottontop) seeded on the Santa Rita Experimental Range in southeast Arizona in 1994. One year after establishment, survival was 92 percent for plains lovegrass, 90 percent for Arizona cottontop, and 92 percent for Lehmann lovegrass. High survival was maintained until the second summer of the study, when many plants that were alive in June 1996 suffered mortality by September 1996. At that time, survival was 10 percent for plains lovegrass, 30 percent for Arizona cottontop, and 76 percent for Lehmann lovegrass. Four years after establishment, survival was zero for plains lovegrass, 16 percent for Arizona cottontop, and 60 percent for Lehmann lovegrass. The second purpose of the study was to determine if Lehmann lovegrass, as a same-aged neighbor, affected the two native grasses differently than same-species neighbors. After 2 years, plains lovegrass mortality was higher with same-species neighbors than no neighbors or Lehmann lovegrass neighbors; cottontop mortality was highest with Lehmann neighbors; and Lehmann mortality was highest with plains lovegrass neighbors. By the end of 4 years, all plains lovegrass seedlings perished regardless of neighbor density (one or two within 40 by 40 cm), spacing (1 to 2 cm or 5 to 6 cm), or species. After 4 years, Arizona cottontop seedlings had 60-percent survival with no neighbors, 10-percent survival across both densities and spacings with same-species neighbors, and no survival with Lehmann lovegrass neighbors. Lehmann lovegrass had 80-percent survival with no neighbors, 60-percent survival with same-species neighbors, and 50-percent survival with native neighbors. These results suggest that the intensity of competition between Lehmann lovegrass and the native grasses increased over the first 4 years.

Keywords: plains lovegrass, Arizona cottontop, invasive species, semiarid grassland ecology, plant competition

Acknowledgments: Funding for planting the research plots in 1994 was provided by the Arizona Heritage Fund. Bruce Munda and Mark Pater at the Natural Resources Conservation Service Plant Materials Center, Tucson, AZ, supplied seed, equipment, and expertise. Field monitoring was assisted by Juan M. Moreno and Carolyn Huntington. Precipitation data sets were provided by the Santa Rita Experimental Range Digital Database (<http://ag.arizona.edu/SRER>). Funding for the digitization of these data was provided by the USDA Forest Service, Rocky Mountain Research Station, and the University of Arizona.

Introduction

Lehmann lovegrass (*Eragrostis lehmanniana* Nees) is a warm-season, perennial bunchgrass native to South Africa that was first introduced to Arizona in the 1930s (Cable 1971). Lehmann lovegrass seed was produced at the USDA Natural Resource

Sharon H Biedenbender is Rangeland Management Specialist with the USDA Forest Service at the Coronado National Forest Sierra Vista Ranger District in Hereford, AZ; e-mail: sbiedenbender@fs.fed.us. She completed a B.S. degree in plant sciences and M.S. and Ph.D. degrees in rangeland management at the University of Arizona. She was a Vegetation Specialist at the USDA Agricultural Research Service, Southwest Watershed Research Center in Tucson, AZ, prior to transferring to the Forest Service. Mitchel P. McClaran is Professor of Range Management, School of Renewable Natural Resources, University of Arizona, Tucson, AZ 85721. Telephone: (520) 621-1673; e-mail: mcclaran@u.arizona.edu. Bruce A. Roundy is Professor of Range Science in the Department of Integrative Biology at Brigham Young University, Provo, UT. He completed an M.S. degree in range management at the University of Nevada, Reno, and a Ph.D. degree in range management at Utah State University, Logan. He has been Range Scientist, USDA Agricultural Research Service, Reno, NV, and Professor of Range Science, School of Renewable Natural Resources, University of Arizona.

In: McClaran, Mitchel P.; Ffolliott, Peter F.; Edminster, Carleton B., tech. coords. Santa Rita Experimental Range: 100 years (1903 to 2003) of accomplishments and contributions; conference proceedings; 2003 October 30–November 1; Tucson, AZ. Proc. RMRS-P-30. Ogden, UT: U.S. Department of Agriculture, Forest Service, Rocky Mountain Research Station.

Conservation Service (NRCS, formerly the Soil Conservation Service) Plant Materials Center, Tucson, AZ, and distributed to soil conservationists and scientists within NRCS for field plantings to stabilize soil and increase forage production in Arizona, New Mexico, and Texas. Areas where Lehmann lovegrass successfully establishes have sandy to sandy loam soils to 120 cm deep, mean summer precipitation greater than 200 mm, and winter temperatures that rarely fall below 0 °C (Cox and Ruyle 1986). Between 1940 and 1950, Lehmann lovegrass began to spread to areas not intentionally seeded. By the mid-1980s, continued seedings and natural spread allowed Lehmann lovegrass to become the most prevalent grass species on approximately 145,000 ha in southeastern Arizona (Cox and Ruyle 1986), and it is still increasing in land coverage (Anable and others 1992).

Lehmann lovegrass may displace native grasses with undesirable ecological consequences such as decreased native wildlife species diversity and abundance (Bock and others 1986), alterations in fire frequency and intensity (Bock and Bock 1992; Cable 1965), and decreased livestock forage quality (Cox and others 1990). Although concern exists regarding the displacement of native grasses by Lehmann lovegrass, the relationship between Lehmann lovegrass and native grasses has not been fully understood. Among the possible mechanisms by which Lehmann lovegrass may compete successfully against native grasses are greater seed production, faster growth rate, lower palatability to herbivores, lower nutrient requirements, and a potential competitive advantage over native range grasses in procuring soil moisture. Many seedling studies indicate that rapid growth rate or large size ensure competitive success (Goldberg 1990). Lehmann lovegrass has been shown to recover from drought more rapidly than native grasses and to spread after drought into areas previously occupied by native grasses (Robinet 1992). Angell and McClaran (2001) found that from 1972 to 2000 native grass species on the Santa Rita Experimental Range (SRER) in southeastern Arizona declined prior to the arrival of Lehmann lovegrass. Abbott and Roundy (2002) showed that Lehmann lovegrass, compared to native grasses, retained a viable seed bank during sporadic early summer precipitation events, hence better ensuring seedling germination and establishment during more consistent late summer rains.

In June and August 1992, 1993, and 1994, native grasses were seeded into existing stands of Lehmann lovegrass on the SRER to determine the effects on native grass establishment of mowing, herbicide application, and burning treatments applied to the Lehmann lovegrass canopy (Biedenbender and Roundy 1996). In June 1994 an arson fire consumed the vegetation in the experimental area, killing most mature Lehmann lovegrass plants and negating treatment effects. However, massive recruitment of Lehmann lovegrass seedlings from the seed bank followed rains occurring in August and September of that year. In addition, excellent native grass seedling establishment resulted from the August 1994 planting. To take advantage of this cohort of same-aged Lehmann lovegrass and native grasses, an experiment with different numbers, spacings, and species of neighbors was executed.

The first purpose of this study was to compare the survival of Lehmann lovegrass and two native grasses (plains lovegrass, *Eragrostis intermedia* Hitchc., and Arizona

cottontop, *Digitaria californica* (Benth.) Henr.). The second purpose was to determine if Lehmann lovegrass, as a same-aged neighbor, affected the two native grasses differently than same-species neighbors. Competition is defined as an interaction between two organisms in which both are negatively affected, whereas an amensal interaction is defined as one in which one organism is negatively affected and the other is unaffected by the neighbor (Burkholder 1952). Competition theory suggests that more closely related individuals compete for resources more intensely than distantly related individuals (Keddy 1989). Based on this theory, same-species neighbors would be expected to compete most intensely, and individuals in the same genus might be expected to compete more intensely with each other than with individuals in a different genus. Lehmann lovegrass and plains lovegrass are in the same genus, whereas Arizona cottontop is not.

The third purpose was to see if the proximity of neighbors affected survival. Removal experiments can indicate if a reduction in the abundance of one species affects the survival and/or production of another (McPherson and DeStefano 2003). If the removal or reduction in number of one species increases the growth or survival of another, it can be inferred that the removed species was competing with the survivor. This study was a removal experiment designed to evaluate whether, during the early stages of plant establishment, Lehmann lovegrass competes with plains lovegrass and Arizona cottontop, and whether the effects of the interaction increase as the number and proximity of Lehmann lovegrass neighbors increases.

Methods

The study site is located in a livestock enclosure containing a Lehmann lovegrass monoculture with scattered mesquite trees. Average annual precipitation is 450 mm, the soil is a sandy loam, slopes are 2- to 5-percent slope, and elevation is approximately 1,075 m (Biedenbender and Roundy 1996). The precipitation record for 1995 to 1998 was obtained from a SRER rain gage near the study site (fig. 1). The long-term annual average from 1972 to 2002 for this rain gage is 388 mm and the long-term average for July through September is 199 mm.

The treatments were installed in December 1994. Quadrats measuring 40 by 40 cm were placed along seeded rows, a target seedling was chosen in the center of each quadrat, and all other vegetation except for the selected neighbors was removed. Target seedlings of Lehmann lovegrass, plains lovegrass, and Arizona cottontop were arranged with no neighbors, one and two same-species neighbors at 1 to 2 and 5 to 6 cm distance, and one and two Lehmann lovegrass neighbors at 1 to 2 and 5 to 6 cm distance (table 1). In addition, quadrats with four Lehmann lovegrass neighbors within 1 to 6 cm were established. Each treatment was replicated five times for a total of N = 150. When two same-species seedlings shared a plot, the southern or western seedling was designated as the target. Every attempt was made to choose target and neighbor seedlings that were representative of the range of seedling sizes present on the site. Also, target and neighbor seedlings of similar size were selected. These treatments allowed for comparisons among two densities and two distances of same-species neighbors

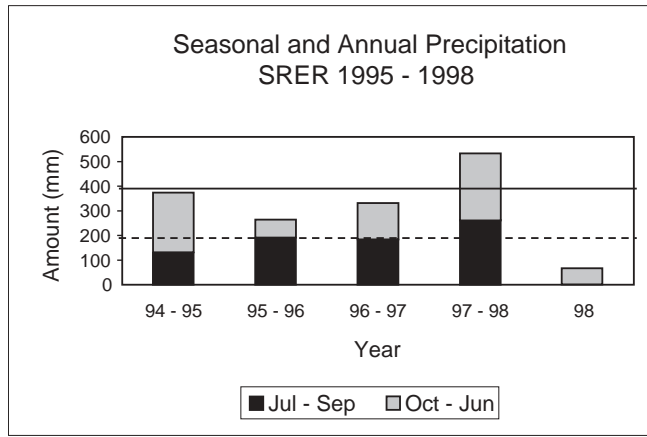

Figure 1—Seasonal and annual precipitation record (mm) from the IBP (Pasture 21) rain gage on the Santa Rita Experimental Range in southeast Arizona, 1995 to 1998; the rain gage is near the Lehmann lovegrass and native grass survival study; the long-term annual average from 1972 to 2002 was 388 mm (—); the long term average for July through September was 199 mm (- - -).

for all three species and among three densities and two distances for Lehmann lovegrass neighbors.

Mortality was determined for target plants in the fall from 1995 through 1998. At the end of the second growing season in the fall of 1996, all quadrats at the 1 to 2 cm and 1 to 6 cm spacing were harvested. Mortality was followed on remaining target plants at the 5 to 6 cm spacing for two more growing

Table 1—Treatments for a Lehmann lovegrass and native grass survival study on the Santa Rita Experimental Range in southeast Arizona, 1995 to 1998; native grasses were plains lovegrass and Arizona cottontop; each target seedling had the following arrangement of neighbors.

Native treatments	
1	No neighbors
2	One same species neighbor at 1 to 2 cm
3	Two same species neighbors at 1 to 2 cm
4	One same species neighbor at 5 to 6 cm
5	Two same species neighbors at 5 to 6 cm
6	One Lehmann lovegrass neighbor at 1 to 2 cm
7	One Lehmann lovegrass neighbor at 5 to 6 cm
8	Two Lehmann lovegrass neighbors at 1 to 2 cm
9	Two Lehmann lovegrass neighbors at 5 to 6 cm
10	Four Lehmann lovegrass neighbors at 1 to 6 cm
Lehmann treatments	
1	No neighbors
2	One Lehmann lovegrass neighbor at 1 to 2 cm
3	One Lehmann lovegrass neighbor at 5 to 6 cm
4	Two Lehmann lovegrass neighbors at 1 to 2 cm
5	Two Lehmann lovegrass neighbors at 5 to 6 cm
6	Four Lehmann lovegrass neighbors at 1 to 6 cm
7	One Arizona cottontop neighbor at 1 to 2 cm
8	One Arizona cottontop neighbor at 5 to 6 cm
9	One plains lovegrass neighbor at 1 to 2 cm
10	One plains lovegrass neighbor at 5 to 6 cm

seasons until the fall of 1998. Mortality was calculated for 1995 and 1996 based on 50 total possible survivors for each species. For 1997 and 1998 mortality calculations were based on 25 total possible survivors due to the harvest of quadrats at 1 to 2 and 1 to 6 cm spacings.

Results

When measured in 1995 the first spring after planting, there was no mortality of target seedlings. In October 1995, 1 year after establishment, total survival across all treatments was 92 percent for plains lovegrass, 90 percent for Arizona cottontop, and 92 percent for Lehmann lovegrass (table 2; fig. 2). High survival was maintained until the second summer of the study, but many plants had suffered mortality by September 1996. At that time, plains lovegrass survival was only 10 percent, Arizona cottontop fared somewhat better with 30 percent, and Lehmann lovegrass survival was an impressive 76 percent. A pattern of winter/spring growth followed by summer mortality was noted in 1995 and repeated in 1996. Mortality during their second summer even befell plants among all three species that had achieved considerable size. Three years after establishment, survival in November 1997 was zero for plains lovegrass, 24 percent for Arizona cottontop, and remained at 76 percent for Lehmann lovegrass. Four years after establishment, survival in November 1998 was 16 percent for Arizona cottontop and 60 percent for Lehmann lovegrass.

Plains lovegrass mortality was higher with same-species neighbors than no neighbors or Lehmann lovegrass neighbors (table 2; fig. 3). Cottontop mortality was highest with Lehmann lovegrass neighbors, and Lehmann mortality was highest with plains lovegrass neighbors. By the end of 4 years, all plains lovegrass seedlings perished regardless of neighbor density (one or two within 40 by 40 cm), spacing (1 to 2 cm or 5 to 6 cm), or species. After 4 years, Arizona cottontop seedlings had 60-percent survival with no neighbors, 10-percent survival across both densities and spacings with same-species neighbors, and zero survival with Lehmann lovegrass neighbors. Lehmann lovegrass had 80-percent survival with no neighbors, 60-percent survival with same-species neighbors, and 50-percent survival with native neighbors, 80 percent with cottontop, and only 20 percent with plains lovegrass (table 2).

Discussion

First-year seedling survival for Arizona cottontop and plains lovegrass was very high and equal to or only somewhat less than Lehmann lovegrass. However, over the next 3 years, Lehmann lovegrass survival surpassed the natives for all of the species-spacing treatments. This study suggests that competitive release activated by the removal of neighbors benefited all three species. Plants with no neighbors within the 40- by 40-cm quadrats had the best survival both short and long term. There was little difference in survival between plants with neighbors at 1 to 2 or 5 to 6 cm. Results were mixed with respect to evidence for greater competition from more closely related neighbors. Plains lovegrass seemed to support the theory, having its lowest survival rate with same-species neighbors. Cottontop, however, had its lowest

Table 2—Four-year survival (percent) across all treatments for Lehmann lovegrass and native grasses having no neighbors, same-species neighbors, or Lehmann lovegrass neighbors on the Santa Rita Experimental Range in southeast Arizona, 1995 to 1998.

	October 1995	September 1996	November 1997	November 1998
Plains lovegrass				
No neighbors	100	20	0	0
Plains neighbors	85	5	0	0
Lehmann neighbors	96	12	0	0
Total survival	92	10	0	0
Arizona cottontop				
No neighbors	100	100	80	60
Cottontop neighbors	80	40	20	10
Lehmann neighbors	88	12	0	0
Total survival	90	30	24	16
Lehmann lovegrass				
No neighbors	100	80	80	80
Lehmann neighbors	100	96	90	60
Plains neighbors	70	40	20	20
Cottontop neighbors	90	60	100	80
Total survival	92	76	76	60

survival rate with neighbors of its most distant relative, Lehmann lovegrass. Lehmann lovegrass experienced its lowest survival rate with plains lovegrass neighbors, its second lowest rate with same-species neighbors, with no difference between cottontop neighbors and no neighbors.

The timing of the greatest mortality for all three species, but especially plains lovegrass and cottontop, suggests that the 2-year-old Lehmann lovegrass plants in this study survived seasonal drought better. The young native and Lehmann lovegrass plants survived their first dry spring-early summer period in 1996, and most were still alive at the June 1996 census. However, between that census and the following one in September, most of the plains lovegrass and cottontop plants perished, whereas many Lehmann lovegrass plants survived. The precipitation record from a nearby rain gage (fig. 1) indicates that both 1995 and 1996 were below average in total annual precipitation (388 mm from 1972 to 2002) and below average in summer precipitation (199 mm for July through September from 1972 to 2002), but they differed in their temporal distribution patterns. Summer moisture was greater in 1996 than 1995, but less for the remainder of the year. Interestingly, there was high survival through the June 1996 census followed by abrupt decline in size or death for most treatments by September. Perhaps a moisture availability threshold was crossed at which plants could no longer sustain life; perhaps as the plants grew larger they required more moisture for survival. In any case, it appears from this study that Lehmann lovegrass survived low moisture availability better than plains lovegrass and Arizona cottontop. It also appears that over the 4 years of this study, the competitive relationship between Lehmann lovegrass and the two native species became stronger and shifted towards amensalism, with Lehmann lovegrass as a neighbor negatively affecting the two natives to a greater extent than they were able to affect Lehmann lovegrass.

Abbott and Roundy (2003) recommend seeding native grasses for revegetation in southeast Arizona in mid to late

summer. Sporadic early summer rains stimulate native grass germination, but seedlings perish during ensuing dry periods that precede the more reliable rainfall events that typically begin in July. Lehmann lovegrass seeds delay germination until soil moisture reserves are better insured by later summer rains. This study followed Lehmann lovegrass and two native grasses from establishment into adulthood and demonstrated that even successfully established native grasses succumbed to seasonal and annual drought conditions that Lehmann lovegrass plants of the same age survived. Because the intensity of competition between Lehmann lovegrass and the native species increased over time, the sequestration of water resources between neighboring adults may be more limiting than between neighboring seedlings.

Alternatively, native grasses may die during drought regardless of whether Lehmann lovegrass is present, and Lehmann lovegrass may colonize sites following native grass decline, as documented on the SRER by Angell and McClaran (2001). The management implications of these findings are not encouraging for revegetation with native grasses in areas where Lehmann lovegrass exists or has the potential to establish. Without Lehmann lovegrass, native grass stands would be expected to recover following drought, but once Lehmann lovegrass is present, it may prevent native recovery.

References

- Abbott, L. B.; Roundy, B. A. 2003. Available water influences field germination and recruitment of seeded grasses. *Journal of Range Management*. 56: 56–64.
- Anable, M. E.; McClaran, M. P.; Ruyle, G. B. 1992. Spread of introduced Lehmann lovegrass *Eragrostis lehmanniana* Nees. in southern Arizona, USA. *Biology Conservation*. 61: 181–188.
- Angell, D. L.; McClaran, M. P. 2001. Long-term influences of live-stock management and a non-native grass on grass dynamics in the Desert Grassland. *Journal of Arid Environments*. 49: 507–520.

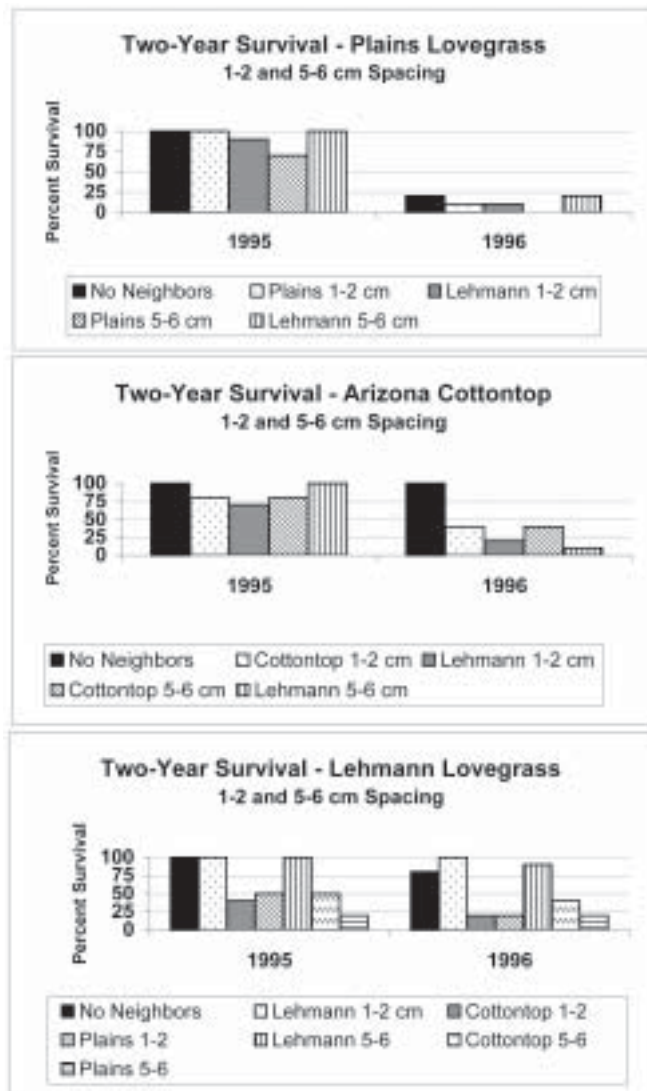

Figure 2—Two-year fall survival for plains lovegrass, Arizona cottontop, and Lehmann lovegrass on the Santa Rita Experimental Range in southeast Arizona, 1995 to 1996; target plants had no neighbors, one or two same-species neighbors, or Lehmann lovegrass neighbors at 1 to 2 or 5 to 6 cm spacing.

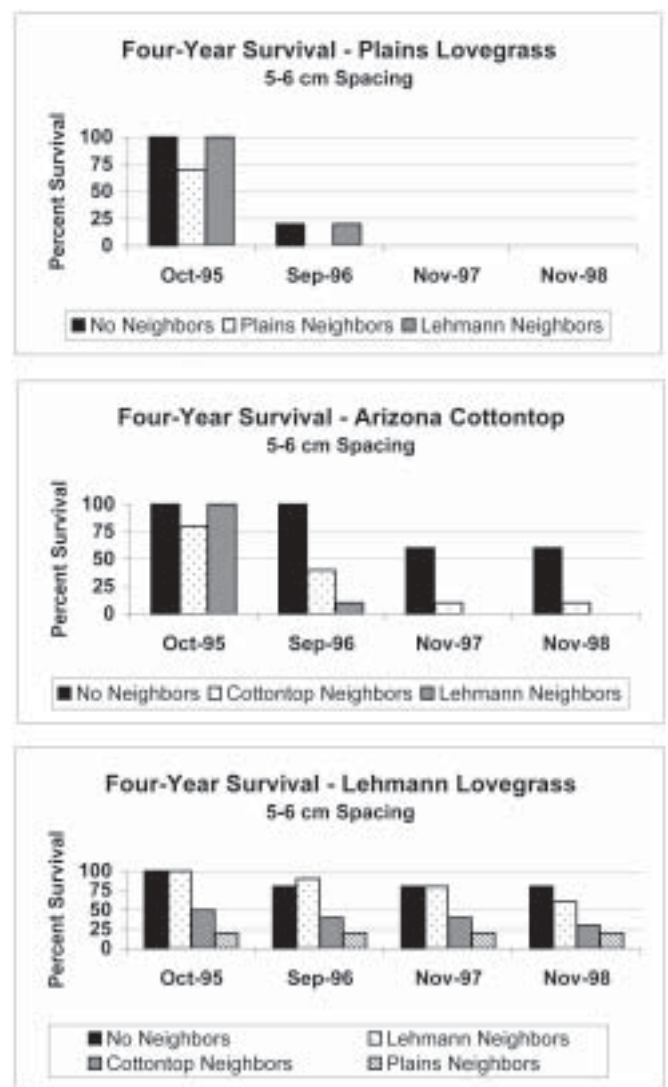

Figure 3—Four-year fall survival for plains lovegrass, Arizona cottontop, and Lehmann lovegrass on the Santa Rita Experimental Range in southeast Arizona, 1995 to 1998; target plants had no neighbors, one or two same-species neighbors, or Lehmann lovegrass neighbors at 5 to 6 cm spacing.

- Biedenbender, S. H.; Roundy, B. A. 1996. Establishment of native semidesert grasses into existing stands of *Eragrostis lehmanniana* in southeastern Arizona. *Restoration Ecology*. 4: 155–162.
- Bock, C. E.; Bock, J. H.; Jepson, K. L.; Ortega, J. C. 1986. Ecological effects of planting African lovegrasses in Arizona. *Natural Geographic Research*. 2: 456–463.
- Bock, J. H.; Bock, C. E. 1992. Vegetation response to wildfire in native versus exotic Arizona grassland. *Journal of Vegetation Science*. 3: 439–446.
- Burkholder, P. R. 1952. Cooperation and conflict among primitive organisms. *American Scientist*. 40: 601–631.
- Cable, D. R. 1965. Damage to mesquite, Lehmann lovegrass, and black grama by a hot June fire. *Journal of Range Management*. 18: 326–329.
- Cable, D. R. 1971. Lehmann lovegrass on the Santa Rita Experimental Range, 1937–1968. *Journal of Range Management*. 24: 17–21.
- Cox, J. R.; Ruyle, G. B. 1986. Influence of climatic and edaphic factors on the distribution of *Eragrostis lehmanniana* Nees in

- Arizona, USA. *Journal of Grassland Society of South Africa*. 3: 25–29.
- Cox, J. R.; Ruyle, G. B.; Roundy, B. A. 1990. Lehmann lovegrass in southeastern Arizona: biomass production and disappearance. *Journal of Range Management*. 43: 367–372.
- Goldberg, D. E. 1990. Components of resource competition in plant communities. In: Grace J. B.; Tilman, D., eds. *Perspectives on plant competition*. San Diego, CA: Academic Press: 27–57.
- Keddy, P. A. 1989. *Competition. Population and community biology series*. London: Chapman & Hall: 90–97.
- McClaran, M. P.; Angell, D. L.; Wissler, C. 2002. Santa Rita Experimental Range Digital Database: user's guide. Gen. Tech. Rep. RMRS-100. Fort Collins, CO: U.S. Department of Agriculture, Forest Service, Rocky Mountain Research Station. 13 p.
- McPherson, G. R.; DeStefano, S. 2003. *Applied ecology and natural resource management*. Cambridge University Press: 17–36.
- Robinett, D. 1992. Lehmann lovegrass and drought in southern Arizona. *Rangelands* 14: 100–103.

Peter F. Ffolliott
Jeffrey O. Dawson
James T. Fisher
Itshack Moshe
Timothy E. Fulbright
W. Carter Johnson
Paul Verburg
Muhammad Shatanawi
Jim P. M. Chamie

International Arid Lands Consortium: A Synopsis of Accomplishments

Abstract: The International Arid Lands Consortium (IALC) was established in 1990 to promote research, education, and training activities related to the development, management, and reclamation of arid and semiarid lands in the Southwestern United States, the Middle East, and elsewhere in the world. The Consortium supports the ecological sustainability and environmentally sound stewardship of these lands in continuing to increase the knowledge base for managers and land owners. Research and development efforts that relate to the IALC's mission are incubated at research centers of its member institutions such as the Santa Rita Experimental Range. Results from the scientific and technical projects supported by the IALC on soil and water resources development and conservation, land use and reclamation, processes enhancing ecological management, and inventorying techniques and monitoring are made available to managers and land owners to improve stewardship of arid and semiarid ecosystems while maintaining the integrity of the ecological processes.

Keywords: arid lands, semiarid lands, research, development, demonstration projects

Acknowledgments: Preparation of this paper was supported by funds provided to the International Arid Lands Consortium by the USDA Forest Service and Cooperative States Research Education, and Extension Service. The authors gratefully acknowledge the reviews of this paper by Steven L. Loring, New Mexico Agricultural Station, Las Cruces, NM, and Darrell W. DeBoer, South Dakota State University, Brookings.

Introduction

The International Arid Lands Consortium (IALC) was established to promote research, education, and training activities related to the development, management, and reclamation of arid and semiarid lands in the Southwestern United States, the Middle East, and elsewhere in the world. The Consortium supports ecological sustainability and environmentally sound land stewardship, while addressing the pressures on natural resources associated with shifting demographics and public expectations and concerns. Areas receiving attention include the reallocation of water from agriculture to urban uses; protection of endangered, threatened, and sensitive plant and animal species; and mitigation of excessive exploitation and

Peter F. Ffolliott is Professor, School of Renewable Natural Resources, University of Arizona, Tucson. Jeffrey O. Dawson is Professor, Department of Natural Resources and Environmental Sciences, University of Illinois, Urbana. James T. Fisher is Professor and Head, Department of Agronomy and Horticulture, New Mexico State University, Las Cruces. Itshack Moshe is Deputy Director, Southern Region, Land Development Authority, Gilat DN Negev, Israel. Timothy E. Fulbright is Regents Professor, Caesar Kieberg Wildlife Research Institute, Texas A&M University-Kingsville, Kingville, TX. W. Carter Johnson is Professor, Department of Horticulture, Forestry, Landscape, and Parks, South Dakota State University, Brookings. Paul Verburg is Assistant Research Professor, Division of Earth and Ecosystem Systems, Desert Research Institute, Reno, NV. Muhammad Shatanawi is Dean, Faculty of Agriculture, University of Jordan, Amman, Jordan. Jim P. M. Chamie is Managing Director, International Arid Lands Consortium, Tucson, AZ.

In: McClaran, Mitchel P.; Ffolliott, Peter F.; Edminster, Carleton B., tech. coords. Santa Rita Experimental Range: 100 years (1903 to 2003) of accomplishments and contributions; conference proceedings; 2003 October 30–November 1; Tucson, AZ. Proc. RMRS-P-30. Ogden, UT: U.S. Department of Agriculture, Forest Service, Rocky Mountain Research Station.

development of limited natural resources. The IALC applies research, development, and demonstration projects, educational and training initiatives, training courses and workshops, and technology transfer activities to the development, management, and reclamation of arid and semiarid lands in the world. Many of these activities are incubated at research centers of its member institutions such as the Santa Rita Experimental Range.

Cooperation and Collaboration _____

The Consortium's member institutions are the University of Arizona, New Mexico State University, the Jewish National Fund, South Dakota State University, the University of Illinois, Texas A&M University-Kingsville, the Desert Research Institute of the University and Community College System of Nevada, Jordan's Higher Council for Science and Technology, and Egypt's Ministry of Agriculture and Land Reclamation. Collaboration with cooperators from other institutions, including the USDA Forest Service, the USDA Cooperative State Research, Education, and Extension Service, the U.S. Agency for International Development, and similar institutions worldwide, is also fostered. The IALC brings people and programs together in diverse areas such as water resource development, conservation, and management; soil resource conservation and management; ecosystem processes; land-use planning and decisionmaking, and inventory technology.

Accomplishments and Contributions _____

Illustrative IALC's accomplishments and contributions are presented in this paper through a synopsis of the research, development, and demonstration projects and initiatives grouped into the categories of soil and water resources development and conservation, land use and reclamation, processes enhancing ecological management, and inventorying techniques and monitoring. A more detailed review of the Consortium's accomplishments and contributions is presented in a 10-year review of its history by Ffolliott and others (2001).

Soil and Water Resources Development and Conservation

The IALC orients its efforts in soil and water resources development and conservation to help people understand what causes losses in soil productivity and to synthesize methods to reclaim degraded soil and water resources. Results from these efforts provide managers and land owners with ways to overcome existing or anticipated limitations in soil and water resources. For example, while the role and importance of arid and semiarid land soils in carbon sequestration are not fully known, management agencies are being pressed to report management impacts on carbon flows and strategies potentially useful to offset carbon emissions. The Consortium's efforts have contributed fresh insights and innovated analytical tools for addressing this

crucial issue in terms of evaluating management impacts and formulating management strategies for this purpose.

Conserving potable water for critical uses is an important water supply issue. Managers and land owners must understand the associated agricultural crop and environmental health risks posed by the water that is locally made available including treated waste water. IALC research has also extended people's knowledge of water and integrated watershed management (Ffolliott and others 2000) and the physical-chemical processes that lead to the contamination of water systems in arid and semiarid regions.

Land Use and Reclamation

A main thrust of the IALC research and development projects in land use and reclamation concerns is developing computer-based systems to improve decisionmaking processes for desert, grassland, and riparian ecosystem management efforts. Managers of these fragile ecosystems generally confront problems that involve several goals and objectives. One such problem can be minimizing the cost of a water management practice while maximizing forage production, with this problem also subject to limited funding, a restricted land base, and a requirement to satisfy the objectives within a specified period. Managers can effectively analyze this type of resource-allocation problem with decision-support systems such as those developed by researchers supported by the IALC. While the themes of these systems have largely centered on plant-water relationships, optimizing livestock stocking rates, and habitat suitability, the general structure of the decision-support systems that have been developed are applicable to a wide spectrum of management topics.

A database template based on knowledge gained on research centers such as the Santa Rita Experiment Range has been developed for rangeland managers to build their own local database systems for planning effective and environmentally sound livestock management practices on public grazing lands in the Southwestern United States. These databases also help researchers to validate predictive models of forage growth and consumptive patterns, teachers and students to learn about the ecological processes of livestock production, and decisionmakers to select the best rangeland management practice.

Processes Enhancing Ecological Management

The IALC research and development activities help people to determine how livestock grazing, invasive shrub control, reseeding activities, and microphytic soil crust occurrences influence plant rangeland diversity, nutrient distribution and productivity, and water capture. The high proportion of the IALC studies relating to biological diversity and productivity of plants and animals, and their functional relationships, reflects the fragility of biodiversity in arid and semiarid land ecosystems. The Consortium has also supported research on genetic and physiological determinants of drought hardiness and the productivity of coniferous trees, fruit-producing cacti, and native herbaceous

plants. Results from these studies provide a basis for selecting, breeding, or genetic modification of plants that tolerate aridity and prolonged heat loads. The improved understanding of genetic diversity and phenotypic plasticity is helping to predict the effects of global climate change and habitat destruction on populations of plants and associated organisms.

Efforts supported by the IALC contribute to people's understanding of how habitat fragmentation, livestock grazing patterns, and herbaceous and shrub invasion affects species diversity and the ecology of desert fauna. The contributing role of small mammals in soil-patch development and maintenance has also been clarified. Studies on ungulates have centered on anti-nutritional factors in leguminous shrubs and development of telemetry to track animals. The effects of landscape-level processes such as habitat fragmentation and desertification on ungulate and predator diversity and population dynamics have also been addressed.

Inventorying Techniques and Monitoring

IALC-supported projects in inventorying and monitoring have focused on developing improved ways to assess the risk that humans pose to the fragile ecology of arid and semiarid environments and, conversely, the hazards that these environments pose to humans (Ffolliott and others 1998, 2001). Research and development that involve the impact of human activities on the environment largely consider the response of vegetative systems to traditional land uses including livestock grazing and agroforestry activities. However, researchers have learned that field-based inventorying and monitoring are often unable to detect subtle changes in landscape conditions caused by these actions, a situation necessitating continued study.

Intensive inventorying and monitoring of small areas are not necessarily representative of the overall condition of the larger landscape. Therefore, techniques have been developed to provide a wide spatial assessment of land surface conditions that are compatible with temporal data sets that represent decades or longer. Geographic information systems play a major role in these research and development activities.

The Future

Where technologically based economic development and urbanization supplants pastoralism and other traditional land uses of arid and semiarid lands, problems of livestock overgrazing, ineffective water conservation, excessive recreation impacts, unwise mining operations, and pollution continue to emerge. Solutions to these problems require careful research and planning to improve the critical balance between humans and their natural resource systems. Efforts to restore and preserve natural and cultural heritage, sustain intensive agricultural enterprises, and maintain biological diversity must be increased. The consequences of overpopulation and resource degradation are dire and, as a result, will challenge political, economic, and scientific leaders. Therefore, the future requires the IALC to be flexible and innovative in meeting its mission. Policies and approaches that increase collaboration must continue. Member institutions will continue to cooperate, collaborate, and contribute within a framework of shared interest in, and concern for, the viability of arid and semiarid ecosystems worldwide.

References

- Ffolliott, P. F.; Fisher, J. T.; Sachs, M.; DeBoer, D. W.; Dawson, J. O.; Fulbright, T. E. 1998. Role of demonstration projects in combating desertification. *Journal of Arid Environments*. 39: 155–163.
- Ffolliott, P. F.; Fisher, J. T.; Sachs, M.; DeBoer, D. W.; Dawson, J. O.; Fulbright, T. E.; Tracy, J. 2000. International Arid Lands Consortium: Better land stewardship in water and watershed management. In: Ffolliott, P. F.; Baker, M. B., Jr.; Edminster, C. B.; Dillon, M. C.; Mora, K. L., tech. coords. *Land stewardship in the 21st century: the contributions of watershed management*. Proc. RMRS-P-13. Fort Collins, CO: U.S. Department of Agriculture, Forest Service, Rocky Mountain Research Station: 335–338.
- Ffolliott, P. F.; Dawson, J. O.; Fisher, J. T.; Moshe, I.; DeBoer, D. W.; Fulbright, T. E.; Tracy, J.; Al Musa, A.; Johnson, C.; Chamie, J. P. M. 2001. *Arid and semiarid land stewardship: a 10-year review of accomplishments and contributions of the International Arid Lands Consortium*. Gen. Tech. Pap. RMRS-GTR-89. Fort Collins, CO: U.S. Department of Agriculture, Forest Service, Rocky Mountain Research Station. 74 p.

Soil and Ecological Sites of the Santa Rita Experimental Range

Abstract: A soil survey and rangeland resource inventory of the Santa Rita Experimental Range (SRER) was conducted by staff from the Tucson office of the Natural Resources Conservation Service (NRCS) during April and May of 1997. Thirty-two soil series and taxadjuncts were mapped on the SRER and delineated in 24 different mapping units. These soils all occur in an Aridic and Ustic moisture regime and span three precipitation zones, and all soils are in the thermic soil temperature regime. Soil series and mapping unit descriptions are provided. The rangeland inventory and the soil map correlate soils into ecological sites and determine the present day status or condition of the sites by comparing present plant communities with potential plant communities as described by NRCS in their technical ecological site descriptions. Eighteen different ecological sites were identified in two Major Land Resource Areas (MLRA 40 and 41) on the SRER, and eight sites were mapped in the 10- to 13-inch precipitation zone of MLRA 40, the Upper Sonoran Desert. Eight sites were mapped in the 12- to 16-inch precipitation zone of MLRA 41, the Southern Arizona Grassland. Two ecological sites were mapped in the 16- to 20-inch precipitation zone of MLRA 41, the Mexican Oak Savannah.

Acknowledgments: GIS data layers for the soils and ecological sites of the SRER were completed by Debbie Angell and Dr. Mitchel P. McClaran of the University of Arizona, School of Renewable Natural Resources (SRNR). Additional maps were provided by Dawn Browning, Graduate Student in SRNR, using the SRNR Advanced Resource Technology (ART) Laboratory facilities. Field work was conducted by Don Breckenfeld, Dan Robinett, Emilio Carrillo, Rob Wilson, Bill Svetlick, and Chuck Peacock of the NRCS. They were assisted by Sue Muir of the University of Arizona SRNR.

Introduction

The soil survey and rangeland resource inventory of the Santa Rita Experimental Range (SRER) were conducted by the Natural Resources Conservation Service staff, Tucson, AZ. The field work was completed during April and May 1997. This is an update of an older soil survey completed in 1971 (Richardson 1971). The information contained in this report will be used by research scientists and range managers for evaluating and utilizing these rangeland resources.

The Cooperative Soil Survey Procedures described and defined in the Soil Survey Manual, Soil Taxonomy, and the National Soils Handbook (Soil Survey Division Staff 1993, 1999, and 1996) were used to classify and describe the soil morphologic properties of the Santa Rita Experimental Range (SRER). The Major Land Resource Areas (MLRA) are defined in U.S. Department of Agriculture (1981), Agricultural Handbook 296, United States Government Printing Office, Washington, DC. Geomorphic landforms definitions as defined in Peterson (1981) and the Soil Survey Division Staff (1996) National Soil Survey Handbook were used.

Thirty-two soil series and taxadjuncts were found on the SRER and delineated in 24 different mapping units (table 1). Taxadjuncts have soil properties that are outside of the recognized soil series by one or more differentiating characteristics of the series. The three taxadjuncts mapped on the SRER could potentially be new soil series if a significant area is eventually

Donald J. Breckenfeld is a Major Land Resource Area Soil Survey Leader with the Natural Resources Conservation Service at the Tucson Soil Survey in Tucson, AZ; phone: 520-670-6482, ext. 242.. He has a B.S. degree in soil science from the University of Arizona, and he started working with the Soil Conservation Service, now the Natural Resources Conservation Service, as a Soil Scientist making soil surveys in 1979. Daniel Robinett is currently a Rangeland Management Specialist with Natural Resources Conservation Service for southern Arizona. He completed a B.S. degree in range management from the University of Arizona and began working as a Range Conservationist in 1972 with the Soil Conservation Service, now the Natural Resources Conservation Service.

In: McClaran, Mitchel P.; Ffolliott, Peter F.; Edminster, Carleton B., tech. coords. Santa Rita Experimental Range: 100 years (1903 to 2003) of accomplishments and contributions; conference proceedings; 2003 October 30–November 1; Tucson, AZ. Proc. RMRS-P-30. Ogden, UT: U.S. Department of Agriculture, Forest Service, Rocky Mountain Research Station.

Table 1—Soil and ecological map unit legend for the Santa Rita Experimental Range.

Map unit	Soil properties
1	Agustin sandy loam, 0 to 3 percent slopes
2	Arizo-Riverwash complex, 0 to 3 percent slopes
3	Baboquivari-Combate complex, 1 to 5 percent slopes
4	Bodecker-Riverwash complex, 1 to 3 percent slope
5	Budlamp-Woodcutter complex, 15 to 60 percent slopes
6	Caralampi sandy loam, 1 to 8 percent slopes
7	Cave-Rillino-Nahda complex, 1 to 10 percent slopes
8	Chiricahua-Lampshire complex, 3 to 18 percent slopes
9	Combate loamy sand, 1 to 8 percent slopes
10	Combate-Diaspar complex, 1 to 5 percent slopes
11	Hayhook-Bucklebar soils complex, 0 to 3 percent slopes
12	Hayhook-Pajarito complex, 0 to 5 percent slopes
13	Keysto-Riverwash complex, 1 to 3 percent slopes
24	Lampshire-Pantak-Rock outcrop complex, 10 to 60 percent slopes
14	Lampshire-Budlamp-Woodcutter complex, 15 to 60 percent slopes ^a
15	Mabray-Rock outcrop complex, 10 to 60 percent slopes percent slopes
16	Nahda-Rillino complex, 1 to 30 percent slope
17	Oversight fine sandy loam complex, 1 to 3 percent slopes
18	Pinalino-Stagecoach complex, 3 to 15 percent slopes
19	Sasabe-Baboquivari complex, 1 to 8 percent slopes
20	Tombstone complex, 0 to 5 percent slopes
21	Topawa complex, 1 to 8 percent slopes
22	Tubac complex, 0 to 2 percent slopes
23	White House-Eloma complex, 1 to 10 percent slopes

^aSoils in this map unit are taxadjuncts.

recognized. These soils all occur in an Aridic and Ustic soil moisture regime spanning three precipitation zones, and a thermic soil temperature regime (mean annual soil temperature at 50-cm depth is 15 to 22 °C).

Figure 1 presents the soil and ecological map of the SRER. The approximate boundaries of the MLRA's are also noted. Table 2 lists the soil depth, drainage class, and land form for each of the soil series, and table 3 lists the taxonomic classification for each soil series. A brief description of the soil mapping units are included below. The detailed pedon description and soil interpretations for each soil series are available online at <http://az.nrcs.usda.gov> under technical resources, and a report by Breckenfeld and Robinett (1997) provide additional information about the SRER soil and rangeland resources.

Descriptions of Soil Map Unit _____

1 Agustin sandy loam, 0 to 3 percent slopes—Composition of this unit is approximately 80 percent Agustin and 20 percent inclusions. Typical profile of Agustin has a yellowish brown sandy loam 0 to 14 cm with 5 to 15 percent surface gravel (A). (The horizon designations as defined in Soil Survey Division Staff [1993] are noted in parenthesis for the major horizons in each soil series. For example an A horizon is the surface horizon with an enrichment of organic matter, a Bk, Bt, and Bw are subsurface horizons with an accumulation of carbonates, clay, and minimally changed horizon, respectively. The C horizons are unconsolidated parent material, and the R horizon is consolidated bedrock.) The subsoil is a pale brown calcareous sandy loam to coarse sandy loam from 14 to 107 cm (Bw,

Bk). The substratum is a calcareous yellowish brown loam from 107 to 150 cm (Bk).

2 Arizo-Riverwash complex, 0 to 3 percent slopes—Composition of this unit is approximately 65 percent Arizo, 25 percent Riverwash and 10 percent inclusions. Typical profile of Arizo has a yellowish brown gravelly loamy sand 0 to 46 cm with 5 to 15 percent surface gravel and cobbles (A). The subsoil is a yellowish brown very gravelly loamy sand from 46 to 150 cm (C). Riverwash consists of unconsolidated material in the channel of an ephemeral stream, commonly bordered by steep to vertical banks cut into the alluvium (Arizo soil). It is usually dry but can be transformed into a temporary watercourse or a short-lived torrent after a heavy rain within the watershed.

3 Baboquivari-Combate complex, 1 to 5 percent slopes—Composition of this unit is approximately 60 percent Baboquivari, 25 percent Combate, and 15 percent inclusions. Typical profile of Baboquivari has a dark yellowish brown loamy sand 0 to 8 cm with 5 to 10 percent surface gravel (A). The subsoil is a brown coarse sandy loam to reddish brown sandy clay loam from 8 to 150 cm (Bt). Typical profile of Combate has a brown loamy sand 0 to 5 cm with 5 to 15 percent surface gravel (A). The subsoil is a dark brown coarse sandy loam to sandy loam from 5 to 150 cm (A, C).

4 Bodecker-Riverwash complex, 1 to 3 percent slopes—Composition of this unit is approximately 65 percent Bodecker, 25 percent Riverwash, and 10 percent inclusions. Typical profile of Bodecker has a brown loamy sand 0 to 8 cm with 5 to 25 percent surface gravel (A). The subsoil is a brown stratified gravelly sand and very gravelly coarse sand coarse sandy loam to sandy loam from 8 to 150 cm (C).

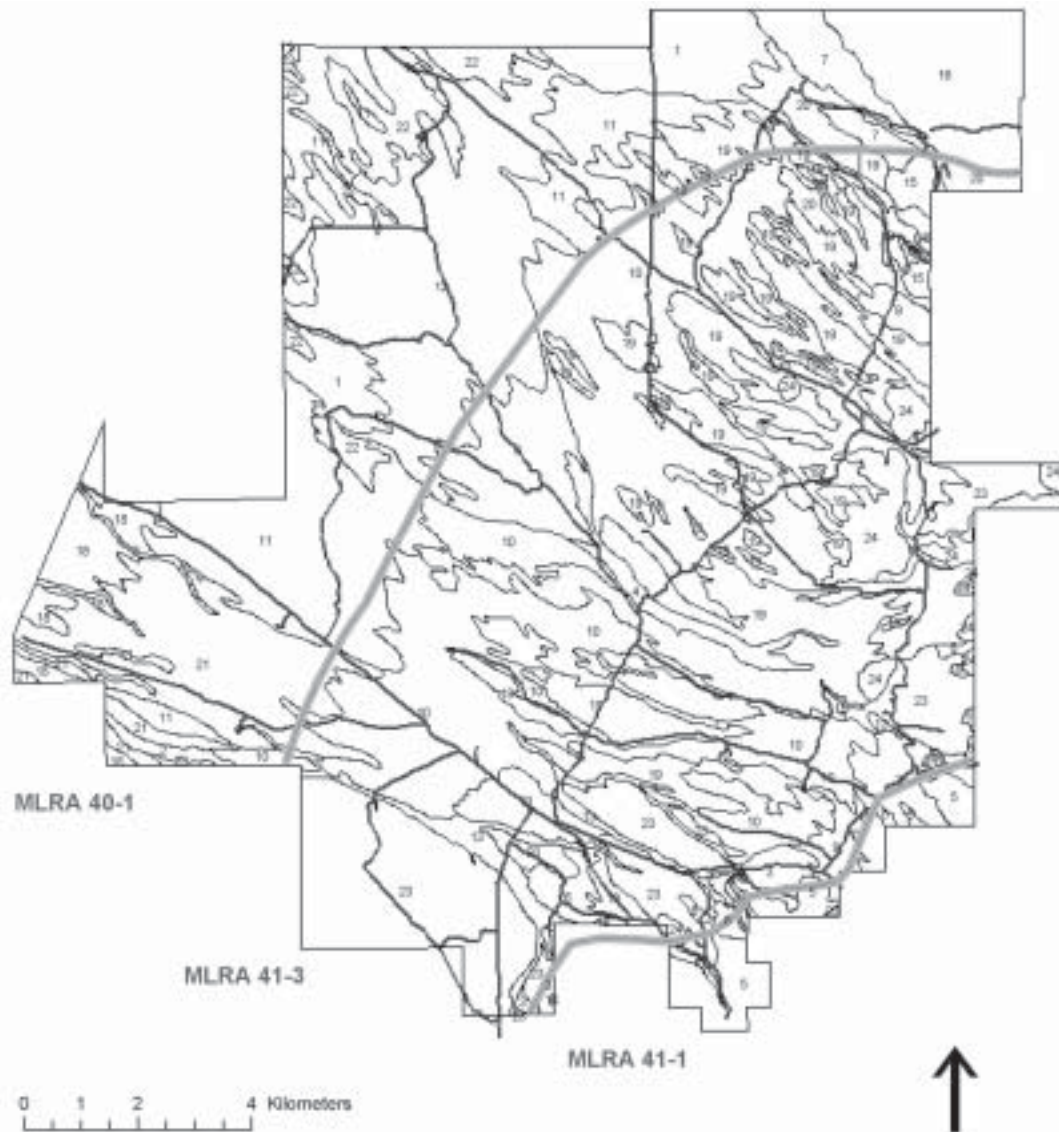

Figure 1—Map of soil and ecological site declinations. this map displays the approximate boundaries of the three MLRAs 40-1, 41-3, and 41-1, and the major roads on the Santa Rita Experimental Range.

Riverwash consists of unconsolidated material in the channel of an ephemeral stream, commonly bordered by steep to vertical banks cut into the alluvium (Bodecker soil). It is usually dry but can be transformed into a temporary water course or a short-lived torrent after a heavy rain within the watershed.

5 Budlamp-Woodcutter complex, 15 to 60 percent slopes—Composition of this unit is approximately 40 percent Budlamp, 30 percent Woodcutter, and 30 percent inclusions. Typical profile of Budlamp has a very dark brown very gravelly sandy loam 0 to 5 cm with 35 to 45 percent surface gravel and cobbles (A). The subsoil is a very dark grayish brown extremely gravelly fine sandy loam dark 5 to 20 cm (C). The next layer is unweathered bedrock at 20 cm (R). Typical profile of Woodcutter has a brown very gravelly fine sandy loam 0 to 5 cm with 35 to 45 percent surface gravel and

cobbles (A). The subsoil is a dark brown to reddish brown very gravelly loam and very gravelly clay loam 5 to 30 cm (Bt). The next layer is unweathered bedrock at 30 cm (R).

6 Caralampi sandy loam, 1 to 8 percent slopes—Composition of this unit is approximately 75 percent Caralampi and 25 percent inclusions. Typical profile of Caralampi has a brown gravelly sandy loam 0 to 15 cm with 5 to 20 percent surface gravel (A). The subsoil is a reddish brown very gravelly sandy clay loam brown coarse sandy loam to a reddish brown extremely cobbly sandy clay loam from 15 to 150 cm (Bt).

7 Cave-Rillino-Nahda complex, 1 to 10 percent slopes—Composition of this unit is approximately 35 percent Cave, 30 percent Rillino, 15 percent Nahda, and 20 percent inclusions. Typical profile of Cave has a brown calcareous gravelly sandy loam 0 to 13 cm (A, Bk) with 30 to

Table 2—Soil depth, drainage class, and geomorphic land forms of 32 soil series mapped on the Santa Rita Experimental Range.

Soil series	Soil depth	Drainage class	Landform
Agustin	Very deep	Well	Fan terrace
Arizo	Very deep	Excessively	Flood plain, Inset fan
Baboquivari	Very deep	Well	Fan terrace
Bodecker	Very deep	Excessively	Flood plain, Inset fan
Bucklebar	Very deep	Well	Fan terrace
Budlamp	Very shallow to shallow	Well	Hills, mountains
Budlamp ^a	Moderately deep	Well	Hills, mountains
Caralampi	Very deep	Well	Fan terrace
Cave	Very shallow to shallow	Well	Fan terrace
Chiricahua	Shallow	Well	Hills, mountains
Combate	Very deep	Well	Alluvial fans
Diaspar	Very deep	Well	Fan terrace
Eloma	Very deep	Well	Fan terrace
Hayhook	Very deep	Well	Fan terrace
Keysto	Very deep	Well	Inset fans, stream terrace
Lampshire	Very shallow to shallow	Well	Hills, mountains
Lampshire*	Moderately deep	Well	Hills, mountains
Mabray	Very shallow to shallow	Well	Hills, mountains
Nahda	Very deep	Well	Fan terrace
Oversight	Very deep	Excessively	Inset fans, stream terrace
Pajarito	Very deep	Well	Fan terrace
Pantak	Very shallow to shallow	Well	Hills, mountains
Pinalino	Very deep	Well	Fan terrace
Rillino	Very deep	Well	Fan terrace
Sasabe	Very deep	Well	Fan terrace
Stagecoach	Very deep	Well	Fan terrace
Tombstone	Very deep	Well	Fan terrace
Topawa	Very deep	Well	Fan terrace
Tubac	Very deep	Well	Basin floor
White House	Very deep	Well	Fan terrace
Woodcutter	Very shallow to shallow	Well	Hills, mountains
Woodcutter ^a	Moderately deep	Well	Hills, mountains

^aAll three soils are taxadjuncts.

40 percent surface gravel. The next layer is an indurated calcium carbonate cemented hardpan from 13 to 25 cm thick (Bkm). Typical profile of Rillino has a pinkish gray sandy loam 10 cm thick with 35 to 40 percent surface gravel (A). The subsoil is a brown to light brown calcareous sandy loam from 10 to 150 cm (Bw, Bk). Typical profile of Nahda has a reddish brown sandy loam 0 to 8 cm with 45 to 55 percent surface gravel and cobbles (A). The subsoil is a dark reddish brown gravelly sandy clay to very gravelly clay from 8 to 61 cm (Bt, Btk). The next layer is a light reddish brown calcareous very gravelly sandy loam from 61 to 87 cm (Bk) and a calcium carbonate cemented hardpan from 87 to 100 cm (Bkm).

8 Chiricahua-Lampshire complex, 3 to 18 percent slopes—Composition of this unit is approximately 60 percent Chiricahua, 20 percent Lampshire, and 20 percent inclusions. Typical profile of Chiricahua has a dark brown cobbly sandy loam 0 to 8 cm with 10 to 35 percent surface

gravel, cobbles, and stones (A). The subsoil is a dark reddish brown very gravelly clay to a gravelly clay loam 8 to 48 cm (Bt). The next layer is weathered bedrock from 48 to 71 cm (Cr) and unweathered bedrock at 71 cm (R). Typical profile of Lampshire has a dark grayish brown very gravelly sandy loam 0 to 20 cm with 15 to 35 percent surface gravel, cobbles, and stones (A, C). The next layer is unweathered bedrock at 20 cm (R).

9 Combate loamy sand, 1 to 8 percent slopes—Composition of this unit is approximately 90 percent Combate and 10 percent inclusions. Typical profile of Combate has a brown loamy sand 0 to 5 cm with 5 to 15 percent surface gravel (A). The subsoil is a dark brown coarse sandy loam to sandy loam from 5 to 150 cm (A, C).

10 Combate-Diaspar complex, 1 to 5 percent slopes—Composition of this unit is approximately 65 percent Combate, 25 percent Diaspar, and 15 percent inclusions.

Table 3—Taxonomic classification of the soil series mapped on the Santa Rita Experimental Range.

Typic Aridic^a: 10- to 12-inch precipitation zone	
Agustin	Coarse-loamy, mixed, superactive, thermic Typic Haplocalcids
Arizo	Sandy-skeletal, mixed, thermic Typic Torriorthents
Bucklebar	Fine-loamy, mixed, superactive, thermic Typic Haplargids
Cave	Loamy, mixed, superactive, thermic, shallow Typic Petrocalcids
Hayhook	Coarse-loamy, mixed, superactive, thermic Typic Haplocambids
Nahda	Clayey-skeletal, mixed, superactive, thermic Typic Petroargids
Pajarito	Coarse-loamy, mixed, superactive, thermic Typic Haplocambids
Pinalino	Loamy-skeletal, mixed, superactive, thermic Typic Calcargids
Rillino	Coarse-loamy, mixed, superactive, thermic Typic Haplocalcids
Stagecoach	Loamy-skeletal, mixed, superactive, thermic Typic Haplocalcids
Topawa	Loamy-skeletal, mixed, superactive, thermic Typic Haplargids
Tubac	Fine, mixed, superactive, thermic, Typic Paleargids
Ustic Aridic^b: 12- to 16-inch precipitation zone	
Baboquivari	Fine-loamy, mixed, superactive, thermic Ustic Haplargids
Bodecker	Sandy-skeletal, mixed, thermic, Ustic Torriorthents
Caralampi	Loamy-skeletal, mixed, superactive, thermic Ustic Haplargids
Chiricahua	Clayey, mixed, superactive, thermic, shallow Ustic Haplargids
Combate	Coarse-loamy, mixed, superactive, nonacid, thermic Ustic Torrifluvents
Diaspar	Coarse-loamy, mixed, superactive, thermic Ustic Haplargids
Eloma	Clayey-skeletal, mixed, superactive, thermic Ustic Haplargids
Keysto	Loamy-skeletal, mixed, superactive, nonacid, thermic Ustic Torriorthents
Lampshire	Loamy-skeletal, mixed, superactive, nonacid, thermic Lithic Ustic Torriorthents
Mabray	Loamy-skeletal, carbonatic, thermic Lithic Ustic Torriorthents
Pantak	Loamy-skeletal, mixed, superactive, thermic Lithic Ustic Haplargids
Sasabe	Fine, mixed, superactive, thermic Ustic Paleargids
Tombstone	Loamy-skeletal, mixed, superactive, thermic Ustic Haplocalcids
White House	Fine, mixed, superactive, thermic Ustic Haplargids
Aridic Ustic^c: 16- to 20-inch precipitation zone	
Budlamp	Loamy-skeletal, mixed, superactive, thermic Lithic Haplustolls
Budlamp ^d	Loamy-skeletal, mixed, superactive, thermic Aridic Haplustolls
Lampshire ^d	Coarse-loamy, mixed, superactive, thermic Aridic Ustochrepts
Oversight	Loamy-skeletal, mixed, superactive, thermic Aridic Ustochrepts
Woodcutter	Loamy-skeletal, mixed, superactive, thermic Lithic Argiustolls
Woodcutter ^d	Loamy-skeletal, mixed, superactive, thermic Aridic Argiustoll

^aTypic Aridic soils are the soils on the drier end of the aridic moisture regime and are also in thermic temperature regime. Average annual precipitation is 7 to 12 inches.

^bUstic Aridic soils are the soils on the moist end of the aridic moisture regime and are also in thermic temperature regime. Average annual precipitation is 12 to 16 inches.

^cAridic Ustic soils are the soils on the drier end of the ustic moisture regime and are also in thermic temperature regime. Average annual precipitation is 16 to 20 inches.

^dSoils are taxadjuncts.

Typical profile of Combate has a brown loamy sand 0 to 5 cm with 5 to 15 percent surface gravel (A). The subsoil is a dark brown coarse sandy loam to sandy loam from 5 to 150 cm (A, C). Typical profile of Diaspar has a brown loamy sand 0 to 13 cm with 5 to 20 percent surface gravel (A). The subsoil is a brown coarse sandy loam to sandy loam from 13 to 150 cm (Bt).

11 Hayhook-Bucklebar soils complex, 0 to 3 percent slopes—Composition of this unit is approximately 50 percent Hayhook, 40 percent Bucklebar (thin and thick surface), and 10 percent inclusions. Typical profile of Hayhook has a yellowish brown loamy sand 0 to 4 cm with 5 to 15 percent surface gravel (A). The subsoil is a pale brown coarse sandy loam to gravelly coarse sandy loam from 4 to 150 cm (Bw, C). Typical profile of Bucklebar (thin surface) has a brown sandy loam 0 to 8 cm with 5 to 20 percent surface gravel (A). The subsoil is a brown to yellowish red sandy clay loam coarse sandy loam from 8 to 150 cm (Bw, Bt). Typical

profile of Bucklebar (thick surface) has a brown sandy loam 0 to 38 cm with 5 to 15 percent surface gravel (A). The subsoil is a brown to yellowish red sandy clay loam coarse sandy loam from 38 to 150 cm (Bw, Bt).

12 Hayhook-Pajarito complex, 0 to 5 percent slopes—Composition of this unit is approximately 50 percent Hayhook, 30 percent Pajarito, and 20 percent inclusions. Typical profile of Hayhook has a yellowish brown loamy sand 0 to 4 cm with 2 to 15 percent surface gravel (A). The subsoil is a pale brown coarse sandy loam to gravelly coarse sandy loam from 4 to 150 cm (illuvial calcium carbonate below 50 cm and noneffervescent above 50 cm) (Bw, Bk). Typical profile of Pajarito has a brown sandy loam 0 to 11 cm with 5 to 15 percent surface gravel (A). The subsoil is a brown to yellowish brown fine sandy loam from 11 to 150 cm (illuvial calcium carbonate above 50 cm and effervescent) (Bw, Bk).

13 Keysto-Riverwash complex, 1 to 3 percent slopes—Composition of this unit is approximately 65 percent Keysto, 25 percent Riverwash, and 10 percent inclusions. Typical profile of Keysto has a brown sandy loam 0 to 7 cm with 5 to 25 percent surface gravel (A). The subsoil is a brown very cobbly sandy loam to extremely cobbly loamy sand from 7 to 150 cm (C). Riverwash consists of unconsolidated material in the channel of an ephemeral stream, commonly bordered by steep to vertical banks cut into the alluvium (Keysto soil). It is usually dry but can be transformed into a temporary watercourse or a short-lived torrent after a heavy rain within the watershed.

24 Lampshire-Pantak-Rock outcrop complex, 10 to 60 percent slopes—Composition of this unit is approximately 40 percent Lampshire, 30 percent Pantak, and 10 percent inclusions. Typical profile of Lampshire has a very dark gray cobbly loam 0 to 20 cm with 15 to 35 percent surface gravel, cobbles, and stones (A). The subsoil is a dark reddish brown very gravelly clay to a gravelly clay loam 8 to 48 cm (Bt). The next layer is unweathered bedrock at 48 cm (R). Typical profile of Pantak has a very brown very gravelly to gravelly sandy loam 0 to 10 cm with 35 to 55 percent surface gravel, cobbles, and stones (A). The subsoil is a brown very gravelly sandy clay loam 10 to 36 cm (Bt). The next layer is unweathered bedrock at 6 cm (R). Rock outcrop consists of barren rock that occurs as ledges and nearly vertical cliffs of tilted and folded formations of bedrock. Rock outcrop also includes areas where the soil depth to bedrock is less than 10 cm. The higher percentage of rock outcrop is in areas near the summit and on steeper slope areas.

14 Lampshire-Budlamp-Woodcutter complex, 15 to 60 percent slopes—Composition of this unit is approximately 40 percent Lampshire, 20 percent Budlamp, 20 percent Woodcutter, and 20 percent inclusions. All three soils in this map unit are taxadjuncts. Typical profile of Lampshire has a brown very cobbly fine sandy loam 0 to 26 cm with 35 to 50 percent surface gravel and cobbles (A). The subsoil is a brown to reddish brown gravelly fine sandy loam and loam 26 to 71 cm (Bw). The next layer is weathered bedrock from 71 to 100 cm (Cr) and unweathered bedrock at 100 cm (R). Typical profile of Budlamp predominately on north slopes has a dark yellowish brown cobbly fine sandy loam 0 to 8 cm with 35 to 55 percent surface gravel and cobbles (A). The subsoil is a dark yellowish brown cobbly loam 8 to 61 cm (C). The next layer is weathered bedrock from 61 to 75 cm (Cr) and unweathered bedrock at 75 cm (R). Typical profile of Woodcutter has a dark brown very gravelly fine sandy loam 0 to 10 cm with 35 to 45 percent surface gravel and cobbles (A). The subsoil is a brown to reddish brown very gravelly sandy clay loam to extremely gravelly fine sandy loam 10 to 64 cm (Bt, B/C). The next layer is weathered bedrock from 64 to 71 cm (Cr) and unweathered bedrock at 71 cm (R).

15 Mabray-Rock outcrop complex, 10 to 60 percent slopes—Composition of this unit is approximately 60 percent Mabray, 30 percent Rock outcrop, and 10 percent inclusions. Typical profile of Mabray has a dark gray brown cobbly to very gravelly calcareous loam 0 to 31 cm with 45 to 55 percent surface gravel, cobbles, and stones (A, Bk). The

next layer is unweathered bedrock at 31 cm (R). Rock outcrop consists of barren rock that occurs as ledges and nearly vertical cliffs of tilted and folded formations of bedrock. Rock outcrop also includes areas where the soil depth to bedrock is less than 10 cm. The higher percentage of rock outcrop is in areas near the summit and steeper slope areas.

16 Nahda-Rillino complex, 1 to 30 percent slopes—Composition of this unit is approximately 45 percent Nahda, 35 percent Rillino, and 20 percent inclusions. Typical profile of Nahda has a reddish brown sandy loam 0 to 8 cm with 45 to 55 percent surface gravel and cobbles (A). The subsoil is a dark reddish brown gravelly sandy clay to very gravelly clay from 8 to 61 cm (Bt). The next layer is a light reddish brown calcareous very gravelly sandy loam from 61 to 87 cm (Btk). The calcium carbonate cemented hardpan is from 87 to 100 cm (Bkm). Typical profile of Rillino has a pinkish gray gravelly sandy loam 0 to 10 cm with 35 to 50 percent surface gravel (A). The subsoil is a brown to light brown calcareous gravelly sandy loam to very gravelly sandy loam from 10 to 150 cm (Bw, Bk).

17 Oversight fine sandy loam complex, 1 to 3 percent slopes—Composition of this unit is approximately 75 percent Oversight and 25 percent inclusions. Typical profile of Oversight has a brown fine sandy loam 0 to 10 cm with 5 to 35 percent surface gravel and cobbles (A). The subsoil is a brown cobbly fine sandy loam to very cobbly sandy loam from 10 to 150 cm (C).

18 Pinalino-Stagecoach complex, 3 to 15 percent slopes—Composition of this unit is approximately 45 percent Pinalino, 40 percent Stagecoach, and 15 percent inclusions. Typical profile of Pinalino has a brown gravelly sandy loam 0 to 5 cm with 45 to 55 percent surface gravel and cobbles (A). The subsoil is a reddish brown extremely cobbly sandy clay loam from 5 to 76 cm (Bt, Btk). The next layer is a calcareous pink extremely gravelly sandy clay loam from 76 to 150 cm (Bk). Typical profile of Stagecoach has a light brown gravelly sandy loam 0 to 10 cm with 35 to 45 percent surface gravel (A). The subsoil is a brown light brown calcareous very gravelly sandy loam to very gravelly loam from 10 to 150 cm (Bw, Bk).

19 Sasabe-Baboquivari complex, 1 to 8 percent slopes—Composition of this unit is approximately 55 percent Sasabe, 35 percent Baboquivari, and 10 percent inclusions. Typical profile of Sasabe (thick surface) has a brown sandy loam 0 to 13 cm with 0 to 10 percent surface gravel (A). The subsoil is a dusky red clay to sandy clay from 13 to 150 cm (Bt). Sasabe (thin surface) has a brown sandy loam 0 to 5 cm with 5 to 15 percent surface gravel (A). The subsoil is a dusky red clay to sandy clay from 5 to 150 cm (Bk). Typical profile of Baboquivari has a dark yellowish brown coarse sandy loam 0 to 20 cm with 0 to 10 percent surface gravel (A). The subsoil is a dark brown gravelly sandy clay loam to sandy clay loam from 20 to 150 cm (Bt).

20 Tombstone complex, 0 to 5 percent slopes—Composition of this unit is approximately 85 percent Tombstone and 15 percent inclusions. Typical profile of Tombstone has a brown calcareous gravelly sandy loam 0 to 23 cm with 35 to 45 percent surface gravel (A, Bw). The subsoil is a brown calcareous very gravelly sandy loam to very gravelly loamy sand from 23 to 150 cm (Bk).

21 Topawa complex, 1 to 8 percent slopes—Composition of this unit is approximately 40 percent Topawa (thick surface), 35 percent Topawa (thin surface), and 25 percent inclusions. Typical profile of Topawa (thick surface) has a brown coarse sandy loam 0 to 15 cm with 5 to 20 percent surface gravel (A). The subsoil is a reddish brown gravelly to very gravelly sandy clay loam from 15 to 150 cm (Bt). Typical profile of Topawa (thin surface) has a brown coarse sandy loam 0 to 10 cm with 5 to 20 percent surface gravel (A). The subsoil is a reddish brown gravelly to very gravelly sandy clay loam from 10 to 150 cm (Bt).

22 Tubac complex, 0 to 2 percent slopes—Composition of this unit is approximately 40 percent Tubac silt loam, 30 percent Tubac sandy loam, and 20 percent inclusions. Typical profile of Tubac silt loam has a brown silt loam 0 to 15 cm with 0 to 10 percent surface gravel (A). The subsoil is a brown to reddish brown clay to sandy clay from 15 to 150 cm (Bt). Typical profile of Tubac sandy loam has a brown sandy loam 0 to 10 cm with 0 to 15 percent surface gravel (A). The subsoil is a brown to reddish brown clay to sandy clay from 15 to 150 cm (Bt).

23 White House-Eloma complex, 1 to 10 percent slopes—Composition of this unit is approximately 45 percent White House, 35 percent Eloma, and 20 percent inclusions. Typical profile of White House has a brown sandy loam 0 to 5 cm with 5 to 15 percent surface gravel (A). The subsoil is a brown to dark reddish brown clay to clay loam from 5 to 150 cm (Bt, C). Typical profile of Eloma has a brown sandy loam 0 to 5 cm with 5 to 15 percent surface gravel (A). The subsoil is a brown to dark reddish brown very gravelly clay to extremely cobbly clay from 5 to 150 cm (Bt).

Description of the Ecological Sites

Eighteen ecological sites were identified in two Major Land Resource Areas (MLRAs) on the SRER in the 1997 inventory. Table 4 lists the soil series and ecological sites found in the MLRA. Eight sites were mapped in the 10- to 13-inch precipitation zone (PZ) of MLRA 40, the Upper Sonoran Desert (D40-1). Soils mapped in this area have typic aridic moisture regimes and thermic temperature regimes. This area occurs below 3,200 ft elevation on the SRER with the exception of the extreme northeast corner where elevations run to 3,700 ft in this MLRA. Eight sites were mapped in the 12- to 16-inch PZ of MLRA 41, the

Southeast Arizona Basin and Range (D41-3). Soils mapped in this zone have an ustic aridic moisture regime and a thermic temperature regime. This area occurs at elevations ranging from 3,200 ft to 4,400 ft. A few steep southern aspects carry up as high as 4,900 ft. Two sites were mapped in the 16- to 20-inch PZ of MLRA 41, the Mexican Oak Savannah (D41-1). Elevations in this zone range from 4,200 ft on north aspects up to the highest elevations on the SRER at 5,150 ft. Soils mapped in this zone have an aridic ustic moisture regime and a thermic temperature regime.

Table 5 shows the ecological sites found on the SRER. The common plant species of the present day plant community are shown for each ecological site. The NRCS Field Office Technical Guide contains more detailed ecological site descriptions with information about climate, soils, potential plant communities, Major Land Resources Areas, and Official Series Descriptions. It is located online at <http://az.nrcs.usda.gov> under technical resources. Several of the older enclosures (fenced on or before 1937) on the SRER are used by NRCS as reference areas for ecological sites in these MLRAs. These include: Enclosure #44, at Gravelly Ridge Station—Loamy upland and Limy slopes D40-1; Enclosure #22—Sandy loam, Deep D41-3; Enclosure #96 at Northwest Station—Sandy loam, Deep D40-1; and Enclosure #8—Sandy loam upland D41-3.

References

- Breckenfeld, Donald J.; Robinett, Daniel. 1997. Soil and range resource inventory of the Santa Rita Experimental Range Pima County, Arizona. Special Report.
- Peterson, F. F. 1981. Landforms of the Basin and Range Province defined for soil survey. Nevada Agricultural Experiment Station Tech. Bull. 28.
- Richardson M. L. 1971. Soil survey of Santa Cruz and parts of Cochise and Pima Counties, Arizona.
- Schoeneberger, P. J.; Wysocki, D. A.; Benham, E. C.; Broderson, W. D. 1998. Field book for describing and sampling soils. U.S. Department of Agriculture, Natural Resources Conservation Service, National Soil Survey Center.
- Soil Survey Divisions Staff. 1996. National soil survey handbook. U.S. Department of Agriculture, Natural Resources Conservation Service.
- Soil Survey Division Staff. 1993. Soil survey manual. U.S. Department of Agriculture Handb. 18. Soil Conservation Service.
- Soil Survey Staff. 1999. Soil taxonomy: a basic system of soil classification for making and interpreting soil surveys. 2d ed.
- United States Department of Agriculture, Soil Conservation Service. 1981. Land resource regions and major land resource areas of the United States. U.S. Department of Agriculture Handb. 296.

Table 4—Major Land Resource Areas and the soil series and ecological sites in the MLRA.

MLRA 40-1, 10- to 13-inch precipitation zone	
1	Agustin sandy loam, 0- to 3-percent slopes Agustin-Limy Fan, 10- to 13-inch precipitation zone
2	Arizo-Riverwash complex, 0- to 3-percent slopes Arizo-Sandy Bottom, 10- to 13-inch precipitation zone
7	Cave-Rillino-Nahda complex, 1- to 10-percent slopes Cave and Rillino-Limy Upland, 10- to 13-inch precipitation zone Nahda-Loamy Upland, 10- to 13-inch precipitation zone
11	Hayhook-Bucklebar complex, 0- to 3-percent slope Hayhook-Sandy Loam, Deep, 10- to 13-inch precipitation zone Bucklebar-Sandy Loam Upland, 10- to 13-inch precipitation zone and Loamy Upland, 10 to 13-inch precipitation zone
12	Hayhook-Pajarito complex, 0- to 5-percent slopes Hayhook-Sandy Loam, Deep, 10- to 13-inch precipitation zone Pajarito-Sandy Loam, Deep, 10- to 13-inch precipitation zone and Limy Fan, 10- to 13-inch precipitation zone
16	Nahda-Rillino complex, 1- to 30-percent slopes Nahda-Loamy Upland, 10- to 13-inch precipitation zone Rillino-Limy Slopes, 10- to 13-inch precipitation zone
18	Pinalino-Stagecoach complex, 3- to 15-percent slopes Pinalino-Loamy Upland, 10- to 13-inch precipitation zone Stagecoach-Limy Slopes, 10- to 13-inch precipitation zone
21	Topawa complex, 1- to 8-percent slopes Topawa-Sandy Loam Upland, 10- to 13-inch precipitation zone and Loamy Upland, 10- to 13-inch precipitation zone
22	Tubac complex, 0- to 2-percent slopes Tubac-Clay Loam Upland, 10- to 13-inch precipitation zone and Loamy Upland, 10- to 13-inch precipitation zone
MLRA 41-3, 12- to 16-inch precipitation zone	
3	Baboquivari-Combate complex, 1- to 5-percent slopes Baboquivari-Sandy Loam Upland, 12- to 16-inch precipitation zone Combate-Sandy Loam, Deep, 12- to 16-inch precipitation zone
4	Bodecker-Riverwash complex, 1- to 3-percent slopes Bodecker-Sandy Bottom, 12- to 16-inch precipitation zone
6	Caralampi sandy loam, 1- to 8-percent slopes Caralampi-Sandy Loam Upland, 12- to 16-inch precipitation zone
8	Chiricahua-Lampshire complex, 3- to 18-percent slopes Chiricahua and Lampshire, Shallow Upland, 12- to 16-precipitation zone
9	Combate loamy sand, 1- to 8-percent slopes Combate, Sandy Loam, Deep, 12- to 16-inch precipitation zone
10	Combate-Diaspar complex, 1- to 5-percent slopes Combate-Sandy Loam, Deep, 12- to 16-inch precipitation zone Diaspar-Sandy Loam Upland, 12- to 16-inch precipitation zone
13	Keysto-Riverwash complex, 1- to 3-percent slope Keysto-Sandy Bottom, 12- to 16-inch precipitation zone
24	Lampshire-Pantak complex, 10- to 60-percent slope Lampshire and Pantak-Granitic Hills, 12- to 16-inch precipitation zone
15	Mabray-Rock outcrop complex, 10- to 60-percent slopes Mabray-Limestone Hills, 12- to 16-inch precipitation zone
19	Sasabe-Baboquivari complex, 1- to 8-percent slopes Sasabe-Sandy Loam Upland, 12- to 16-inch precipitation zone and Loamy Upland, 12- to 16-inch precipitation zone Baboquivari-Sandy Loam Upland, 12- to 16-inch precipitation zone
20	Tombstone complex, 0- to 5-percent slopes Tombstone-Limy Fan, 12- to 16-inch precipitation zone
23	White House-Eloma complex, 1- to 10-percent slopes White House and Eloma-Loamy Upland, 12- to 16-inch precipitation zone
MLRA 41-1, 16- to 20-inch precipitation zone	
5	Budlamp-Woodcutter complex, 15- to 60-percent slopes Budlamp and Woodcutter-Shallow Hills, 16- to 20-inch precipitation zone
14	Lampshire-Budlamp-Woodcutter complex, 15- to 60-percent slopes ^a Lampshire, Budlamp and Woodcutter-Shallow Hills, 16- to 20-inch precipitation zone
17	Oversight fine sandy loam, 1- to 3-percent slopes Oversight-Sandy Bottom, 16- to 20-inch precipitation zone

^aSoils are taxadjuncts.

Table 5—Descriptions of the ecological sites mapped on the Santa Rita Experimental Range.

Ecological site^a	MLRA^a	Site number^a	Important plant species
Limy fan 10-13	40-1	040XA108AZ	Creosotebush, bush muhly, pappusgrass, fluffgrass
Sandy Bottom 10-13	40-1	040XA115AZ	Mesquite, catclaw, annuals, paloverdes, dropseed spp.
Limy upland 10-13	40-1	040XA111AZ	Creosote, zinnia, ratany, bush muhly, threeawn spp.
Loamy upland 10-13	40-1	040XA114AZ	Ratany, false mesquite, snakeweed, threeawn spp.
Sandy loam upland 10-13	40-1	040XA118AZ	Mesquite, burroweed, Arizona cottontop, threeawns
Sandy loam, deep 10-13	40-1	040XA117AZ	Mesquite, burroweed, bush muhly, threeawns
Limy slopes 10-13	40-1	040XA110AZ	Whitethorn acacia, ocotillo
Clay loam upland 10-13	40-1	040XA120AZ	black grama, bush muhly
Sandy loam upland 12-16	41-3	041XC319AZ	Tobosa, prickly pear annual forbs and grasses
Sandy loam, deep 12-16	41-3	041XC318AZ	Mesquite, Lehmann love, burroweed, threeawn spp.
Sandy bottom 12-16	41-3	041XC316AZ	Mesquite, Lehmann love, burroweed, threeawn spp.
Shallow upland 12-16	41-3	041XC322AZ	Mesquite, catclaw, desert willow, blue paloverde
Granitic hills 12-16	41-3	041XC306AZ	Mesquite, Lehmann love, prickly pear, grama spp.
Limestone hills 12-16	41-3	041XC307AZ	Grama spp., buckwheat, plains love, mimosa spp.
Loamy upland 12-16	41-3	041XC313AZ	Tridens spp., rosewood, ocotillo, whitethorn
Limy fan 12-16	41-3	041XC325AZ	Mesquite, false mesquite, Lehmann love, grama spp.
Sandy bottom 16-20	41-1	041XA112AZ	Creosote, bush muhly, threeawns, pappusgrass
Shallow hills 16-20	41-1	041XA102AZ	Oak spp, catclaw, mesquite hackberry, sycamore, ash
			Oak spp, grama spp, plains lovegrass, bluestem spp.

^aDescription located online at <http://az.nrcs.usda.gov> under technical resources.

Gerald J. Gottfried
Peter F. Ffolliott
Pablo Garcia
Diego Valdez-Zamudio
Akram Al-Khouri

Assessment of Fire-Damaged Mesquite Trees 8 Years Following an Illegal Burn

Abstract: Effects of an illegal burn on the Santa Rita Experimental Range on mesquite (*Prosopis velutina*) survival in the semidesert grass-shrub ecosystem was initially assessed in terms of fire-damage classes 18 months after the fire and again 8 years after the burn. While many of the mesquite trees on the burned site were damaged by the fire, some of the trees appear to have recovered to preburn conditions. The effects of the burn on mesquite stocking characteristics and sprouting mortality were also determined from the latter assessment. Results obtained from the 8-year assessment add to the knowledge about the effects of fire on mesquite trees in semidesert grass-shrub ecosystems of the Southwestern United States.

Keywords: mesquite trees, fire-damaged, survival, postfire sprouting

Acknowledgments: The authors gratefully acknowledge the reviews of this paper by Malcolm J. Zwolinski, University of Arizona, Tucson, Carolyn H. Sieg, USDA Forest Service, Flagstaff, AZ, and Ronald J. Bemis, USDA Natural Resources Conservation Service, Douglas, AZ.

Introduction

An illegal fire burned approximately 80 acres of a mesquite-dominated semidesert grass-shrub rangeland in Sawmill Canyon on the Santa Rita Experimental Range in the early summer of 1994. The initial effects of this burn on the mesquite component of the burned ecosystem were assessed in the late fall of 1995, about 18 months after the fire (DeBano and others 1996). This paper reports on a followup assessment of the effects of the burn on mesquite trees 8 years after the fire. The current assessment was made to determine the extent to which fire-damaged mesquite trees have succumbed or recovered from the burn and whether stocking by mesquite has returned to preburn conditions in the absence of management practices to prevent their return. The information contributes to the earlier literature base (Alonso 1967; Cable 1965; Cox and others 1990; DeBano and others 1996; McLaughlin and Bowers 1982; Reynolds and Bohning 1956; White 1969; and others) on the effects of fire on mesquite in semidesert grass-shrub ecosystems of the Southwestern United States.

Fire Site

The fire burned on a rocky site about 1¹/₂ miles from the Florida Canyon Headquarters near the southern boundary of the Experimental Range. The site is 3,900 ft in elevation on largely southerly slopes ranging from 5 to 20 percent. Soil information is not available for the site. The prefire overstory was dominantly mesquite with ocotillo (*Fouquieria splendens*) scattered throughout. The prefire herbaceous cover based on similar sites at Santa Rita was dominated by Lehmann lovegrass (*Eragrostis lehmanniana*), a species that was introduced onto the Experimental Range in the 1930s (Cox and Roundy 1986), with black grama (*Bouteloua eriopoda*) and Arizona cottontop (*Digitaria californica*) intermixed. Cattle grazed the site in accordance with research plans prepared by the University of Arizona (Womack 2000). Fuel loadings before the fire are unknown.

Gerald J. Gottfried is Research Forester, Rocky Mountain Research Station, USDA Forest Service, Phoenix, AZ, phone: 602-225-5357. Peter F. Ffolliott and Pablo Garcia are Professors and Research Assistants, School of Renewable Natural Resources, University of Arizona, Tucson. Diego Valdez-Zamudio is Professor, Faculty of Agriculture, University of Sonora, Hermosillo, Sonora, Mexico. Akram Al-Khouri is Professor, Faculty of Agriculture, Damascus University, Damascus, Syria. In: McClaran, Mitchel P.; Ffolliott, Peter F.; Edminster, Carleton B., tech. coords. Santa Rita Experimental Range: 100 years (1903 to 2003) of accomplishments and contributions; conference proceedings; 2003 October 30–November 1; Tucson, AZ. Proc. RMRS-P-30. Ogden, UT: U.S. Department of Agriculture, Forest Service, Rocky Mountain Research Station.

Methods

Numbers of fire-damaged mesquite trees and mesquite with no visible fire damage were tallied on 40 $\frac{1}{20}$ -acre temporary plots spaced at 100-ft intervals along a series of randomly located transects traversing the burned area. The tallied mesquite trees were classified in terms of the following fire-damage classes:

- No visible damage
- Partial crown damage (initially classified as scorched crowns) with and without basal sprouting
- Complete crown kill (initially classified as either shoot killed or root killed) with and without basal sprouting

Diameter at root collar (d.r.c.) was measured on the single-stemmed trees that were tallied and equivalent diameter at root collar (e.d.r.c.) was calculated for multiple-stemmed trees (Chojnacky 1988). Equivalent diameter at root collar is the square root of the sum of squared d.r.c. values of the individual stems. These diameter measurements were later related to the occurrence of mesquite trees in the fire-damage classes.

Statistical comparisons of the assessment of fire-damaged mesquite trees 18 months after the fire with respect to the assessment made 8 years following the burn were limited because of the differences in the nature of the two sampling procedures. Temporary plots were established in both of the assessments, precluding remeasurements of the same tallied trees. Also, there was a larger number of $\frac{1}{20}$ -acre plots (60) in the initial postfire assessment. Although the same area of the burn was sampled in both assessments, the placement of transects was another factor. A Fisher's Exact Test and a chi-square tests were used to evaluate the proportion of stocked plots and the distribution of trees among damage classes. Statistical significance is indicated by an $\alpha = 0.05$. General trends and relative comparisons are reported in this paper. If the sample in each assessment is assumed to be representative of the burned area, these data should provide insights into changes over the past 8 years.

Results and Discussion

A total of 79 mesquite trees (equivalent to 39.5 trees per acre) were tallied on 18 (45 percent) of the 40 plots. The remaining plots were not stocked with mesquite. A total of 257 mesquite trees (equivalent to 85.7 trees per acre) were tallied on 37 (61.7 percent) of plots traversing the burned site 18 months after the fire (DeBano and others 1996). The apparent reduction in the stocking of mesquite trees is attributed largely to the intervening mortality of severely fire-damaged trees tallied 18 months after the burn. However, the proportion of stocked plots was not significantly reduced over the 8-year period.

The percent of mesquite trees in the respective fire-damage classes for the two assessments is shown in figure 1. The distribution among classes differed significantly between the two periods. While the number of trees tallied 8 years after the fire was smaller, the relative proportions of trees with no visible damage, partial crown damage (scorched crowns), and complete crown kill with basal sprouting (shoot killed) were largely similar in the two assessments. There was a decrease in the relative portions of trees that experienced complete

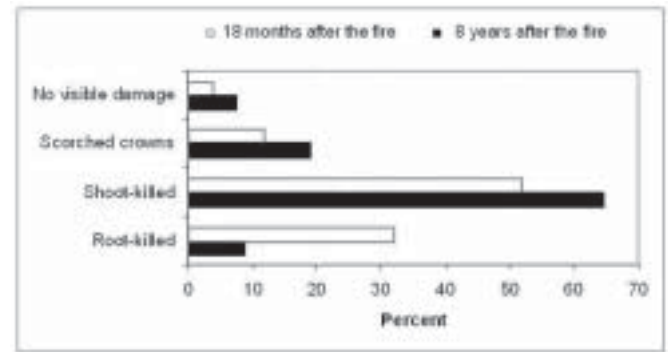

Figure 1—Percent of mesquite trees in fire-damage classes 18 months and 8 years following the Sawmill Canyon fire on the Santa Rita Experimental Range.

crown kill with no sprouting (root killed). This finding was partially due to incorrectly identifying mesquite trees in this fire-damage class in the initial assessment.

The sampled mesquite trees in 2003 ranged from 0.8 to 16.2 inches in diameter at d.r.c. or e.d.r.c. There were no relationships between the occurrence of mesquite trees in the fire-damage classes and their respective diameters (either d.r.c. or e.d.r.c.) or between the occurrence of these trees and the total number of trees that were tallied on the plots. This finding was similar to that reported in the initial assessment of the burn (DeBano and others 1996). Such relationships (or the lack of these relationships) are mostly fire specific (Cable 1965; McLaughlin and Bowers 1982; Reynolds and Bohning 1956; White 1969; Womack 2000) and probably affected by the interactions of fire intensity and fire-damaged tree size.

The postfire sprouting characteristics of mesquite 8 years after the burn were the same as those observed by Cable (1965), White (1969), and McLaughlin and Bowers (1982). Basal sprouts originating below the ground surface were the most commonly observed form of sprouting in the trees with partial crown damage (initially scorched crowns) in both postfire assessments. Basal sprouts were also observed in trees with complete crown kill, which were assumed to be shoot killed but not root killed 18 months after the fire.

Management Inferences

It was postulated that stocking by mesquite trees might return to preburn conditions in the absence of management practices to prevent their return in the 18-month assessment (DeBano and others 1996). However, this level of restocking had not occurred 8 years after the fire, and it is unlikely that it will be attained in the near future. It is concluded, therefore, that the Sawmill Canyon fire effectively converted a semidesert grass-shrub rangeland originally stocked (to an unknown level) with mesquite trees to a rangeland of relatively few mesquite trees. However, the effects of the reduction in tree density on the herbaceous cover are unknown. Fire has been reported to be effective in eliminating mesquite from semidesert grass-shrub rangelands in other studies (Cable 1965, 1967, 1972; Humphrey 1963, 1969; Martin 1975, 1983; Reynolds and Bohning 1956;

White 1969). These latter studies mostly involved applications of prescribed burning treatments rather than the occurrence of a wildfire as reported in this paper.

References

- Alonso, R. C. 1967. Desert grassland mesquite and fire. Tucson: University of Arizona. 164 p. Dissertation.
- Cable, D. R. 1965. Damage to mesquite, Lehmann, and black grama by a hot June fire. *Journal of Range Management*. 18: 326–329.
- Cable, D. R. 1967. Fire effects on semidesert grasses and shrubs. *Journal of Range Management*. 20: 170–176.
- Cable, D. R. 1972. Fire effects in Southwestern semidesert grass-shrub communities. Tall Timbers Fire Ecology Conference. 1972: 150–153.
- Chojnacky, D. C. 1988. Juniper, pinyon, oak, and mesquite volume equations for Arizona. Res. Pap. INT-391. Ogden, UT: U.S. Department of Agriculture, Forest Service, Intermountain Forest and Range Experiment Station. 11 p.
- Cox, J. R.; Roundy, G. B. 1986. Influence of climatic and edaphic factors on the distribution on *Eragrostis lehmanniana* in Arizona, U.S.A. *Journal of the Grassland Society of South Africa*. 3: 25–29.
- Cox, J. R.; Ibarra-F., A; Martin-M, M. H. 1990. Fire effects on grasses in semiarid deserts. In: Krammes, J. S., tech. coord. Effects of fire of Southwestern natural resources. Gen. Tech. Rep. RM-191. Fort Collins, CO: U.S. Department of Agriculture, Forest Service, Rocky Mountain Forest and Range Experiment Station: 43–49.
- DeBano, L. F.; Gottfried, G. J.; Villanueva-Diaz, J.; Ffolliott, P. F.; Valdez-Zamudio, D. 1996. Initial assessment of fire-damaged mesquite trees following an illegal burn. In: Ffolliott, P. F.; DeBano, L. F.; Baker, M. B., Jr.; Gottfried, G. J.; Solis-Garza, G.; Edminster, C. B.; Neary, D. G.; Allen, L. S., tech. coords. Effects of fire on Madrean Province ecosystems; a symposium proceedings. Gen. Tech. Rep. RM-GTR-289. Fort Collins, CO: U.S. Department of Agriculture, Forest Service, Rocky Mountain Forest and Range Experiment Station: 226–228.
- Humphrey, R. R. 1963. The role of fire in the desert grassland areas of Arizona. Tall Timbers Fire Ecology Conference. 1963: 45–62.
- Humphrey, R. R. 1969. The past role of fire in range management in the Southwest and some future possibilities. In: Wagle, R. F., ed. Proceeding of a conference on fire ecology and control and use of fire in wildland management: 52–56.
- Martin, S. C. 1975. Ecology and management of Southwestern semidesert grass-shrub ranges: The status of our knowledge. Res. Pap. RM-156. Fort Collins, CO: U.S. Department of Agriculture, Forest Service, Rocky Mountain Forest and Range Experiment Station. 39 p.
- Martin, S. C. 1983. Response of semidesert grasses and shrubs to fall burning. *Journal of Range Management*. 36: 604–610.
- McLaughlin, S. P.; Bowers, J. E. 1982. Effects of wildfire on a Sonoran desert plant community. *Ecology*. 63: 246–248.
- Reynolds, H. G.; Bohning, J. W. 1956. Effects of burning on a desert grass-shrub range in southern Arizona. *Ecology*. 37: 769–777.
- White, L. D. 1969. Effects of a wildfire on several desert grassland shrub species. *Journal of Range Management*. 22: 284–285.
- Womack, J. D. 2000. Mortality and sprouting vigor of burned and cut velvet mesquite (*Prosopis velutina* Wooten): the role of basal diameter and number of stems. Tucson: University of Arizona. 61 p. Thesis.

Larry D. Howery
Bruce D. Munda
Dan G. Robinett
Harry H. Buck

Sweet Resin Bush on the Santa Rita Experimental Range: An Eradication Effort

Abstract: Sweet resin bush (*Euryops subcarnosus* DC ssp. *vulgaris* B. Nord; or, *Euryops multifidus* (L. f.) DC.), a South African shrub introduced to Arizona in the 1930s, was discovered on the Santa Rita Experimental Range (SRER) in 1998. Due to the threat of spread of this invasive plant and its potential to cause adverse environmental and economic effects, and because it posed a threat to the Federally listed endangered Pima pineapple cactus (*Coryphantha sheerii* Muehlenph. L.D. Benson var. *robustispina* L.D. Benson), we initiated a project in early 1999 with the overall goal of eradicating about 154 acres of the shrub from SRER. Prior to initial treatments in 1999, permanent monitoring plots were randomly established within grazed and ungrazed areas that contained heavy, moderate, or no amounts of sweet resin bush. Plant cover (percent) and density (plants per 15m²) were sampled in January and February for 4 consecutive years (1999 to 2002). Sweet resin bush was hand grubbed in 1999, 2000, and 2001. Picloram (Tordon 22K) was spot sprayed via a backpack sprayer in February 1999 to soil areas where sweet resin bush had been grubbed. Initial eradication treatments in 1999 (mechanical + chemical) greatly reduced sweet resin bush species composition and density, and apparently released soil moisture and nutrients, allowing some native plants to re-establish in 2000. Sweet resin bush seedling density increased substantially in 2001; however, the combined effects of mechanical and herbicidal treatments along with periodic drought substantially reduced sweet resin bush density and canopy cover by 2002. No new seed production occurred for sweet resin bush on SRER during this 4-year study, and we detected no encroachment of sweet resin bush into uninfested control plots (grazed or ungrazed). Although this project greatly reduced sweet resin bush on SRER, total eradication of the shrub was not accomplished. Surveys and eradication efforts for sweet resin bush are planned on SRER for at least another 10 years.

Acknowledgments: We appreciate the dedication of AmeriCorps and Boy Scout volunteers who worked hard to remove sweet resin bush from SRER. We acknowledge Dr. Mitchel McClaran who contributed ideas regarding project design and data collection procedures, and Dr. Ed Northam and Doug Parker for their critical review, which greatly improved an earlier draft of this paper. We thank Beth Jordan and Valerie Oriole for their assistance with field data collection. Precipitation data presented in this paper were accessed via SRER Database (<http://ag.arizona.edu/SRER/>). The USDA Forest Service Rocky Mountain Research Station and the University of Arizona provided funding for the digitization of these data.

Introduction

Sweet resin bush is a low-growing, South African shrub that was introduced into several areas of southern and central Arizona during the 1930s (Pierson and McAuliffe 1995). The shrub was selected for introduction into the arid southwest

Larry D. Howery has worked as an Assistant and Associate Professor and Range Extension Specialist with the University of Arizona in Tucson since 1995. Larry completed B.S. and M.S. degrees in wildlife science at Texas Tech University, and a Ph.D. degree in range science at Utah State University. Contact Larry at: School of Renewable Natural Resources, 325 Biological Sciences East, University of Arizona, Tucson, AZ 85721; telephone: (520) 621-7277; e-mail: lhowery@ag.arizona.edu. Bruce D. Munda has worked for the Soil Conservation Service (now the Natural Resource Conservation Service) since 1975. Bruce received a B.S. degree in agriculture (minor in watershed hydrology and range management) and an M. S. degree in agronomy and plant genetics from the University of Arizona. Dan G. Robinett has worked for the Soil Conservation Service (now the Natural Resource Conservation Service) for the last 31 years as a Rangeland Management Specialist in southern Arizona. Dan received a B.S. degree in range management from the University of Arizona. Harry H. Buck worked for the Agriculture Research Service's Range section from 1987 to 1992 as a Range Technician. He has worked as Farm Superintendent at the Natural Resource Conservation Service's Tucson Plant Materials Center since 1992.

In: McClaran, Mitchel P.; Ffolliott, Peter F.; Edminster, Carleton B., tech. coords. Santa Rita Experimental Range: 100 years (1903 to 2003) of accomplishments and contributions; conference proceedings; 2003 October 30–November 1; Tucson, AZ. Proc. RMRS-P-30. Ogden, UT: U.S. Department of Agriculture, Forest Service, Rocky Mountain Research Station.

because it could readily propagate from seed and was extremely drought resistant. Other perceived benefits included the exotic shrub's ability to control soil erosion and provide nutritional forage for sheep. Paradoxically, some areas where sweet resin bush was introduced has experienced reduced ground cover, increased soil erosion, and decreased forage production. The shrub exhibited a remarkable ability to displace native vegetation and transform extensive landscapes into monocultures, and unfortunately proved to be unpalatable to domestic and wild herbivores. Currently, sweet resin bush infests several thousand acres in southern and central Arizona (McAuliffe 2000).

In 1998, an employee from the Natural Resource Conservation Service (NRCS) discovered a dense core infestation and several smaller "satellite" stands of sweet resin bush scattered across approximately 154 acres in and near the Gravelly Ridge Exclosure of SRER. Due to the threat of spread of this invasive plant and its potential to cause adverse environmental and economic effects, NRCS, the University of Arizona, Arizona State Lands Department, and U.S. Fish and Wildlife Service (USFWS) decided to cooperatively plan and implement a multiyear project to eradicate SRER sweet resin bush infestation. The USFWS was consulted because the Federally listed endangered Pima pineapple cactus was known to occur in the project area and was threatened by sweet resin bush expansion.

Objectives of this 4-year project were to (1) contain sweet resin bush expansion on SRER using mechanical and chemical control measures to remove plants around the infestation's perimeter, working inward to remove the core infestation; (2) evaluate effectiveness of combined mechanical and herbicidal control techniques; and (3) monitor changes in species composition and density in grazed and ungrazed plots that contained heavy, moderate, or no amounts of sweet resin bush. We monitored infested and uninfested areas, and grazed and ungrazed areas to evaluate potential influences of sweet resin bush and disturbance associated with grazing on plant community dynamics.

Methods

Pima Pineapple Cactus

In compliance with USFWS consultation, conservation measures were developed and implemented before eradication treatments were executed to locate and protect individual Pima pineapple cactus plants growing in or near areas infested by sweet resin bush. A detection team, consisting of employees from NRCS, the University of Arizona, and AmeriCorps volunteers, implemented USFWS sampling protocol. Pima pineapple cactus plant locations were recorded in a global positioning system (GPS) and flagged prior to applying treatments in 1999.

Sweet Resin Bush and Other Vegetation

In January 1999, we randomly established a total of 24 15-m² permanent plots in grazed (outside the Gravelly Ridge Exclosure) and ungrazed areas (inside the Gravelly Ridge Exclosure) that were ocularly estimated to contain a heavy, moderate, or no sweet resin bush cover. We collected

baseline plant cover and density data for grasses, forbs, and woody plants detected in permanent plots just prior to applying treatments (table 1). Cover data were collected using the line intercept technique to determine basal (grasses) or canopy (forbs, cactus, and woody species) cover along permanent 15-m transects. Cover data were used to calculate species composition for two life form categories plus sweet resin bush (herbaceous vegetation, cactus and woody vegetation other than sweet resin bush, and sweet resin bush). For density data, we counted individual plant species rooted within permanent 15-m² plots. Density data were tallied by individual plant species and summarized using six life form categories plus sweet resin bush (annual grass, annual forb, perennial grass, perennial forb, woodies, cactus, and sweet resin bush).

In February 1999, nine AmeriCorps volunteers spent 2 weeks hand grubbing sweet resin bush using hoes, picks, shovels, and hand pulling. The sweet resin bush core infestation consisted of about 5 acres that were heavily infested, and a few satellite infestations that radiated outward from the core infestation to encompass a total of 154 acres. AmeriCorps volunteers were instructed to remove all sweet resin bush plants (mature and seedlings) from satellite and

Table 1—Plant species sampled in permanent sampling plots on Santa Rita Experimental Range, 1999 to 2002.

Common name	Scientific name
Grasses	
Arizona cottontop	<i>Digitaria californica</i> (Benth.) Henr.
Bush muhly	<i>Muhlenbergia porteri</i> Scribn. ex Beal
Fluffgrass	<i>Erioneuron pulchellum</i> (H.B.K.) Tateoka
Lehmann lovegrass	<i>Eragrostis lehmanniana</i> Nees
Plains bristlegrass	<i>Eragrostis intermedia</i> Hitchc.
Rothrock grama	<i>Bouteloua rothrockii</i> Vasey
Six-weeks grama	<i>Bouteloua aristoides</i> (H.B.K.) Griseb.
Slender grama	<i>Bouteloua repens</i> (H.B.K.) Scribn. & Merr.
Three awn spp.	<i>Aristida</i> spp.
Forbs	
Ayenia	<i>Ayenia insulicol</i> Cristobal
Deerweed	<i>Porophyllum gracile</i> Benth.
Desert senna	<i>Senna baubinioides</i> (Gray) Irwin & Barneby
Ditaxis	<i>Argythamnia neomexicana</i> Muell. Arg.
Evolvulus	<i>Evolvulus arizonicus</i> Gray
Nightshade	<i>Solanum</i> spp.
Purple aster	<i>Machaeranthera tanacetifolia</i> (Kunth) Nees
Sida	<i>Sida abutilifolia</i> P. Mill.
Spurge	<i>Chamaesyce albomarginata</i> (Torr. & Gray)
Woodies and cactus	
Burroweed	<i>Isocoma tenuisecta</i> Greene
Cactus spp.	<i>Opuntia</i> spp.
Desert zinnia	<i>Zinnia acerosa</i> (DC.) Gray
False mesquite	<i>Calliandra eriophylla</i> Benth.
Janusia	<i>Janusia gracilis</i> Gray
Mesquite	<i>Prosopis velutina</i> Woot.
Mormon tea	<i>Ephedra</i> spp.
Palo verde	<i>Cercidium</i> spp.
Range ratany	<i>Krameria grayi</i> Rose & Painter
Sweet resin bush	<i>Euryops subcarosus</i> DC. spp. <i>vulgaris</i> B. Nord
Whitethorn	<i>Acacia constricta</i> Benth.
Wolfberry	<i>Lycium</i> spp.

core infestations. As the crew removed individual sweet resin bush plants, a one-time Picloram (Tordon 22K; 1 qt ai/acre) treatment was applied via a backpack sprayer to soil areas where shrubs were grubbed to kill seedlings that might germinate near parent plants in subsequent years. No herbicide was applied within 30 m of any Pima pineapple cactus plant as directed by USFWS. Boy Scout volunteers also helped to mechanically remove sweet resin bush plants during the summer and fall of 1999 and 2000. In March of 2001, another AmeriCorps crew spent 1 week scouting the original 154-acre infestation and mechanically removing any sweet resin bush plants found growing in the formerly infested area. We collected post-treatment plant cover, species composition, and density data during January and February of 2000 to 2002 in the same manner described for pretreatment baseline data collected in 1999. Precipitation data for the Gravelly Ridge Exclosure were accessed via SRER Database.

Results and Discussion

Pima Pineapple Cactus

A total of 21 Pima pineapple cactus plants were located outside the core sweet resin bush infestation, and near "satellite" infestations. No Pima pineapple cactus plants were detected within the core infestation itself, or within any of our permanent monitoring plots.

Species Composition

Prior to treatments in 1999, sweet resin bush respectively made up 72 and 64 percent of species composition in heavily infested grazed and ungrazed plots (figs. 1A,B) and 41 and 11 percent in moderately infested grazed and ungrazed plots (figs. 2A,B). After 1999 treatments, no plot contained more than 10 percent sweet resin bush from 2000 to 2002. Thus, combined mechanical and herbicidal treatments were effective in initially removing sweet resin bush cover from treated plots.

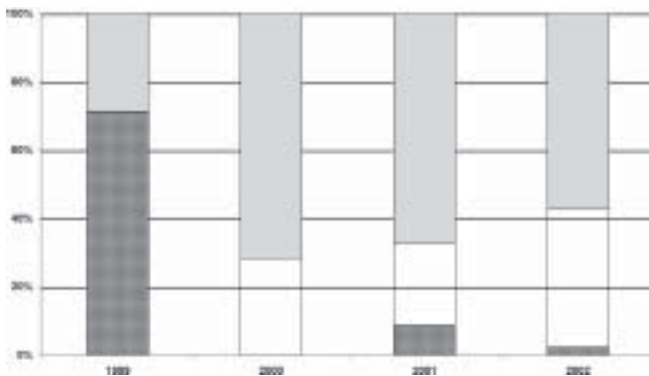

Figure 1A—Species composition (percent) in heavily infested grazed plots before (1999) and after (2000, 2001, and 2002) eradication efforts near the Gravelly Ridge Exclosure, SRER (clear bars = herbaceous vegetation; light gray bars = cactus and woody vegetation other than sweet resin bush; darkest bars = sweet resin bush).

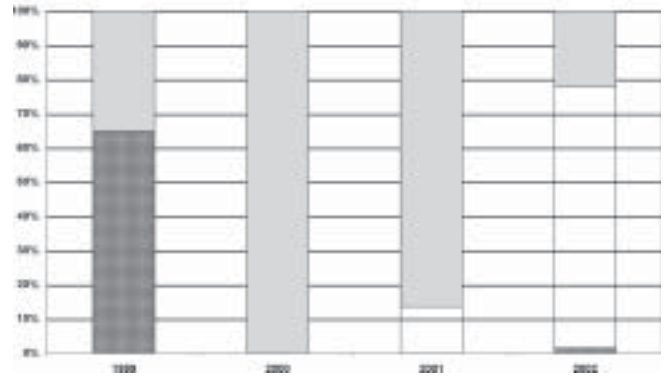

Figure 1B—Species composition (percent) in heavily infested ungrazed plots before (1999) and after (2000, 2001, and 2002) eradication efforts near the Gravelly Ridge Exclosure, SRER (clear bars = herbaceous vegetation; light gray bars = cactus and woody vegetation other than sweet resin bush; darkest bars = sweet resin bush).

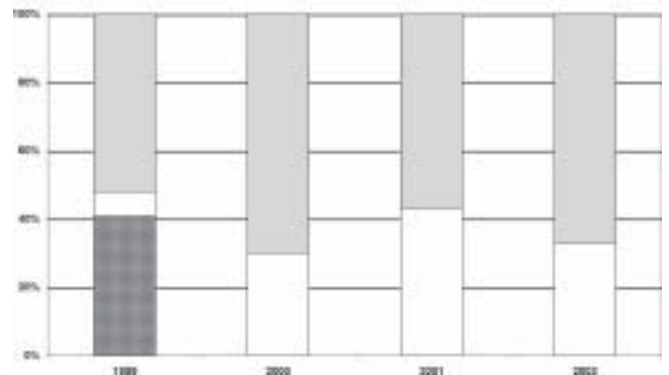

Figure 2A—Species composition (percent) in moderately infested grazed plots before (1999) and after (2000, 2001, and 2002) eradication efforts near the Gravelly Ridge Exclosure, SRER (clear bars = herbaceous vegetation; light gray bars = cactus and woody vegetation other than sweet resin bush; darkest bars = sweet resin bush).

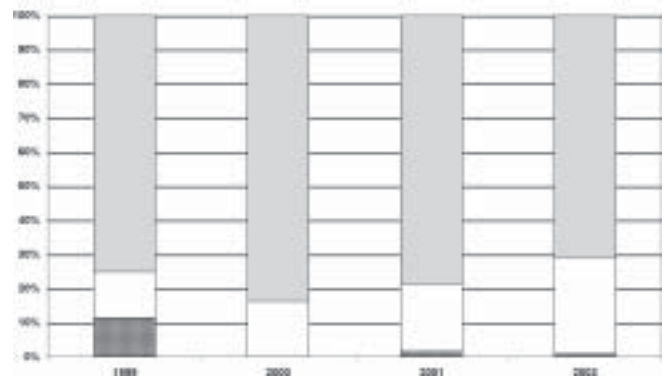

Figure 2B—Species composition (percent) in moderately infested ungrazed plots before (1999) and after (2000, 2001, and 2002) eradication efforts near the Gravelly Ridge Exclosure, SRER (clear bars = herbaceous vegetation; light gray bars = cactus and woody vegetation other than sweet resin bush; darkest bars = sweet resin bush).

Species composition remained relatively stable in control plots from 1999 to 2002, although grazed control plots contained higher relative amounts of herbaceous cover than ungrazed control plots every year of the study (figs. 3A,B). No sweet resin bush plants were detected in grazed or ungrazed control transects or plots in any year of the study.

Density

Prior to treatments in 1999, mean sweet resin bush density was respectively 167 and 67 sweet resin bush plants per 15 m² in heavily infested grazed and ungrazed plots (tables 2A,B), and 85 and 39 plants per 15 m² in moderately infested grazed and ungrazed plots (tables 3A,B). These same plots contained less than four sweet resin bush plants in 2000. Little precipitation occurred from January to May

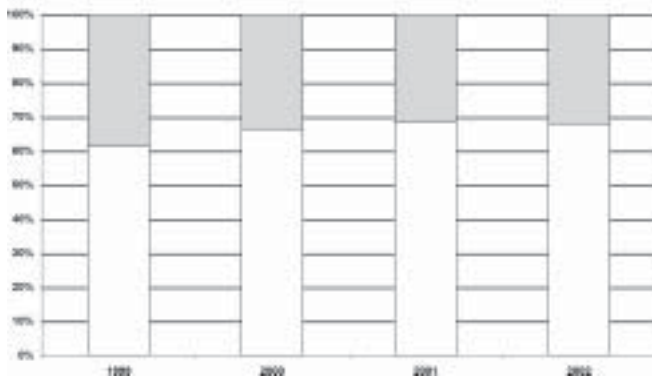

Figure 3A—Species composition (percent) in grazed plots with no sweet resin bush before (1999) and after (2000, 2001, and 2002) eradication efforts near the Gravelly Ridge Exclosure, SRER (clear bars = herbaceous vegetation; light gray bars = cactus and woody vegetation other than sweet resin bush).

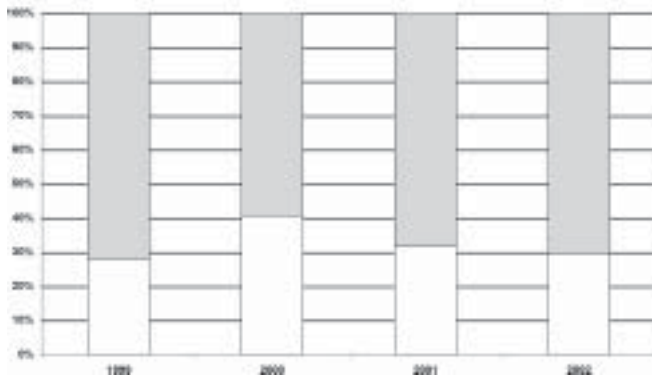

Figure 3B—Species composition (percent) in ungrazed plots with no sweet resin bush before (1999) and after (2000, 2001, and 2002) eradication efforts near the Gravelly Ridge Exclosure, SRER (clear bars = herbaceous vegetation; light gray bars = cactus and woody vegetation other than sweet resin bush).

Table 2A—Mean density (plants per 15 m², ± 6 SE) of sweet resin bush and other plants by life form in grazed plots that were heavily infested with sweet resin bush in 1999.

Life form	Year			
	1999	2000	2001	2002
Annual grass	0	7	154	0
Annual forb	15	13	165	179
Perennial grass	3	26	87	121
Perennial forb	0	2	10	4
Woodies	21	6	7	6
Cactus	0	0	0	0
Sweet resin bush	167	2	134	17

Table 2B—Mean density (plants per 15 m², ±6 SE) of sweet resin bush and other plants by life form in ungrazed plots that were heavily infested with sweet resin bush in 1999.

Life form	Year			
	1999	2000	2001	2002
Annual grass	0	1	43	40
Annual forb	8	0	312	303
Perennial grass	0	4	23	17
Perennial forb	0	0	8	2
Woodies	17	4	3	4
Cactus	1	0	1	1
Sweet resin bush	67	1	21	3

Table 3A—Mean density (plants per 15 m², ± 6 SE) of sweet resin bush and other plants by life form in grazed plots that were moderately infested with sweet resin bush in 1999.

Life form	Year			
	1999	2000	2001	2002
Annual grass	0	3	282	10
Annual forb	120	23	488	410
Perennial grass	28	38	26	24
Perennial forb	3	11	24	11
Woodies	12	12	11	11
Cactus	9	3	5	2
Sweet resin bush	85	2	4	2

Table 3B—Mean density (plants per 15 m², ± 6 SE) of sweet resin bush and other plants by life form in ungrazed plots that were moderately infested with sweet resin bush in 1999.

Life form	Year			
	1999	2000	2001	2002
Annual grass	0	9	153	6
Annual forb	86	22	680	474
Perennial grass	45	119	10	50
Perennial forb	21	9	20	1
Woodies	41	21	29	20
Cactus	5	11	6	5
Sweet resin bush	39	3	64	3

1999 (1.76 inches), which likely hindered sweet resin bush germination and the ability of Picloram to kill actively growing sweet resin bush seedlings during the first year of the study. January to May precipitation in 2000 was even more limited (1.55 inches), which apparently continued to limit sweet resin bush germination, and thus, herbicide kill of shrub seedlings.

In early 2001, sweet resin bush seedling density substantially increased in heavily infested grazed and ungrazed plots (tables 2A,B), and in moderately infested ungrazed plots (table 3B). Fall, winter, and spring (October to May) precipitation was above average in 2000 to 2001 (11.85 inches), which provided a favorable opportunity for sweet resin bush seedlings to germinate in 2001. Another Americorp crew mechanically removed these seedlings in 2001 about 1 month after plots were sampled, which helped to reduce sweet resin bush density by January and February 2002 (less than 18 plants per 15 m²; tables 2A,B, and 3B). Moreover, data collected in early 2002 fell in the middle of another very dry fall, winter, and spring (only 1.27 inches of precipitation from October 2001 to May 2002), which likely inhibited additional sweet resin bush germination during this dry spell.

Annual grasses and annual forbs showed slight to dramatic increases in density in at least one of the years after sweet resin bush was initially treated (2000 to 2002), especially in early 2001 following the wettest year of the study (19.39 inches in 2000). The flush of annuals in early 2001 coincided with the substantial increase of sweet resin bush seedlings during the same time. Grazed and ungrazed control plots also exhibited dramatic annual plant production in 2001 (tables 4A,B).

Table 4A—Mean density (plants per 15m², ± 6 SE) of sweet resin bush and other plants by life form in grazed plots that contained no sweet resin bush in 1999.

Life form	Year			
	1999	2000	2001	2002
Annual grass	0	9	15	1
Annual forb	70	203	670	269
Perennial grass	14	25	13	14
Perennial forb	11	79	40	5
Woodies	7	7	5	5
Cactus	1	1	4	2
Sweet resin bush	0	0	0	0

Table 4B—Mean density (plants per 15 m², ± 6 SE) of sweet resin bush and other plants by life form in ungrazed plots that contained no sweet resin bush in 1999.

Life form	Year			
	1999	2000	2001	2002
Annual grass	0	9	4	4
Annual forb	90	286	1,224	879
Perennial grass	7	9	6	4
Perennial forb	26	120	81	9
Woodies	12	13	13	12
Cactus	0	0	0	0
Sweet resin bush	0	0	0	0

Mechanical and herbicidal treatments in the heavily and moderately infested plots (both grazed and ungrazed) in 1999 apparently reduced competition for soil moisture and nutrients, allowing an increase in perennial grass density by 2000 (tables 2A,B; 3A,B). Summer rainfall in 1999 (9.6 inches from June to September) was favorable for warm season perennial grass production, which was detected in our plots in early 2000.

Woody plant density declined substantially in heavily infested plots (both grazed and ungrazed) and in moderately infested plots that were ungrazed after the initial eradication treatment in 1999. Volunteers may have mistaken native, low-growing shrubs for sweet resin bush because density reductions occurred in false mesquite (*Calliandra eriophylla* Benth.), range ratany (*Krameria grayi* Rose & Painter), and desert zinnia (*Zinnia acerosa* (DC.) Gray). Picloram applied to grubbed areas could also have injured or killed native shrubs. Conversely, woody plant density remained remarkably constant in both grazed and ungrazed control plots where no mechanical or herbicidal treatments were applied (tables 4A,B).

Summary and Conclusions

Combined mechanical and chemical control measures were effective in initially removing core and satellite sweet resin bush infestations from the Gravelly Ridge area of SRER. Sweet resin bush removal in 1999 apparently released soil moisture and nutrients, allowing some components of the native plant community to begin reestablishing within 1 year. However, timing and amount of precipitation (or lack thereof) was apparently the major factor driving plant community dynamics throughout the project. Drought in early and late 1999 and throughout the first half of 2000 likely kept sweet resin bush seedling production at bay until late 2000 or early 2001; hence, there was negligible opportunity for Picloram to kill sweet resin bush seedlings during this dry period.

This field project integrated mechanical and herbicidal control measures during above and below average precipitation years and was not designed to differentiate sweet resin bush mortality due to mechanical removal, Picloram, or drought (for example, no sweet resin bush plants were left intact to monitor drought-caused mortality). Mechanical removal of sweet resin bush by volunteers in 1999, 2000, and 2001 certainly played a key role in keeping sweet resin bush in check throughout the project. In addition, both Picloram and drought likely impaired sweet resin bush seedling production during the 4-year project. However, Picloram could not override the effects of above average precipitation in late 2000, which stimulated a substantial increase in sweet resin bush seedling density in most plots by the time they were measured in early 2001. We speculate that without the one-time Picloram application in 1999, sweet resin bush seedling density may have been even more pronounced in 2001. It is noteworthy that the combined effects of mechanical and herbicidal treatments, in addition to periodic drought, prevented any new seed production by sweet resin bush for the entirety of our 4-year project.

Grazed plots were located immediately outside of the grazing enclosure to intentionally select a "worst case scenario" for grazing disturbance because areas near fences are

typically associated with amplified disturbance associated with livestock and wildlife trailing. Sweet resin bush species composition and density were initially higher in grazed versus ungrazed plots, indicating that disturbance may have facilitated sweet resin bush establishment in heavily impacted areas. However, no sweet resin bush plants were detected in grazed or ungrazed control plots during the entire study, demonstrating that the shrub had not established and did not spread approximately 400 m north where control plots were located. Moreover, no sweet resin bush plants were detected in grazed areas outside the original 154-acre infestation where grazing disturbance was much lower than in grazed study plots located immediately outside the enclosure. Thus, light to moderate grazing apparently did not facilitate the spread of sweet resin bush on SRER.

Noxious weed invaders often exhibit the potential to explode after a long period of slow and unapparent growth (Sheley and Petroff 1999). The 154-acre sweet resin bush infestation on SRER has not expanded to the degree other sweet resin bush infestations have in Arizona (for example, about 3,000 acres on Frye Mesa in east-central Arizona). Nevertheless, several cooperating agencies and organizations justified eradicating this invasive shrub from SRER for several reasons. First, the SRER sweet resin bush infestation was small enough to justify eradication as a goal. Second, SRER sweet resin bush infestation is only 5 km from the Santa Cruz River where seeds could potentially be transported hundreds of miles during flood events. Third, the stand is only 6 km from Green Valley, a rapidly growing urban area between Tucson and Nogales. This area, with increasing traffic and large disturbed areas around construction sites, offers ideal conditions for the shrub to spread. Fourth, Interstate 19 from Tucson to Nogales is an international corridor on which nearly two-thirds of the winter produce coming into the United States is transported each year. Hence, seed from SRER could easily become a source of introduction of sweet resin bush into Mexico. Finally, USFWS views sweet resin bush as a direct threat to Pima pineapple

cactus survival because SRER is the only large area of prime cactus habitat currently protected from development.

Although we did not accomplish our main goal of eradicating sweet resin bush from SRER, significant progress was made during this project. Mechanical and herbicidal treatments along with periodic drought substantially reduced sweet resin bush density and canopy cover on SRER since 1999. The fact that no new seed production occurred on SRER during this project is of paramount importance in depleting the shrub's residual seed bank, thereby reducing and eventually eliminating its capacity to reproduce in the future. Conservation measures developed during this project to identify and protect individual Pima pineapple cactus plants were successful. This project has begun to restore native plants to the previously infested area, thereby facilitating habitat recovery for the cactus, and severely limiting the potential for additional colonies of sweet resin bush to establish in uninfested endangered cactus habitat. Nevertheless, the detection of significant numbers of sweet resin bush seedlings in 2001 indicates the crucial need for follow-up monitoring when invasive plants are targeted for eradication (Sheley and Petroff 1999). Survey and eradication efforts are planned on SRER during the next 10 years.

References

- McAuliffe, J. R. 2000. The battle against a harmful alien invader: sweet resin bush from South Africa. *The Sonoran Quarterly*. 54: 4–9.
- Pierson, E. A.; McAuliffe, J. R. 1995. Characteristics and consequences of invasion by sweet resin bush into the arid Southwestern United States. In: *Biodiversity and management of the Madrean Archipelago: the sky islands of Southwestern United States and Northwestern Mexico*. Gen. Tech. Rep. RM-GTR-264. Fort Collins, CO: U.S. Department of Agriculture, Forest Service, Rocky Mountain Forest and Range Experiment Station: 291–230
- Sheley, R. L.; Petroff, J. K. 1999. *Biology and management of noxious rangeland weeds*. Corvallis: Oregon State University Press. 438 p.

A. Karim Batchily
Donald F. Post
R. B. Bryant
Donald J. Breckenfeld

Spectral Reflectance and Soil Morphology Characteristics of Santa Rita Experimental Range Soils

Abstract: The Santa Rita Experimental Range (SRER) soils are mostly transported alluvial sediments that occur on the piedmont slope flanking the Santa Rita Mountains in Arizona. The major geomorphic land forms are alluvial fans or fan terraces, but there are also areas of residual soils formed on granite and limestone bedrock, basin floor, stream terraces, and flood plains. The soils range in age from recent depositions to soil material one to two million years of age. We sampled A and B horizons of soil series from different geomorphic surfaces, and measured the dry spectral reflectance (0.4 to 2.5 mm wavelength) on the sieved less than 2-mm-size fraction. Soil color (measured with a Chroma Meter), texture, organic carbon, calcium carbonate content, and effervescence properties were determined and correlated to spectral reflectance in selected wavelengths. The Munsell soil color value component was most positively correlated to reflectance. Soil effervescence and calcium carbonate content, percent sand and clay, and the Munsell soil color hue component and redness rating were also significantly correlated to soil reflectance. Energy reflected from soil surfaces represents the interaction between many soil properties, and soil color is an integrated expression of many soil properties. It is the best soil morphology property to measure to predict the spectral reflectance of soils, particularly in the visible and near infrared parts of the electromagnetic spectrum.

Acknowledgments: The Soils Map GIS data for the Santa Rita Experimental Range (SRER) were completed by Debbie Angell and Dr. M. McClaran, and the manipulation of this data to prepare the geomorphic land form map was prepared by Dawn Browning and Mamadou Niane, University of Arizona, School of Renewable Natural Resources (SRNR). The SRNR Advanced Resource Technology (ART) Laboratory facilities were utilized to create the geomorphic land form map of the SRER. Special thanks are extended to Mary Kay Amistadi and Dr. Jon Chorover, Department of Soil, Water and Environmental Science, University of Arizona, for determining the organic carbon and calcium carbonate content of the SRER soils. We also thank Dr. M. S. Moran, the USDA Agricultural Research Service, Tucson, AZ, for allowing us to use her Analytical Spectral Device to measure spectral reflectance.

Introduction

Jenny (1941, 1980) presents a soil formation equation that states a soil is a product of the interaction of the five "Factors of Soil Formation," namely climate, biota, parent material, time, and topography. Within the Santa Rita Experimental Range

A. Karim Batchily is a Research Specialist in the Department of Soils, Water and Environmental Science (SWES) at the University of Arizona. He received a B.S. degree in agronomy from the Agronomic Institute Nicolae Balcescu, Bucharest, Romania, in 1982, and an M.S. degree in soil science from the University of Arizona in 1991. He has more than 10 years of experience in soils and remote sensing. Donald F. Post is Professor Emeritus of soil science from the Soil, Water and Environmental Science Department, University of Arizona; e-mail: postdf@ag.arizona.edu. He joined the University of Arizona faculty in 1967 and has taught classes in basic soils, soil morphology and classification, and soil and water conservation from 1967 until the present. His research has been in soil morphology and classification, and in using remotely sensed data to map soils and other natural resources. R. B. Bryant is a research specialist employed by the USDA Agricultural Research Service in Tucson, AZ. He has a B.A. degree in geology from Colorado College, and he completed an M.S. degree in soil and water science from the University of Arizona in 1990. Donald J. Breckenfeld is a Major Land Resource Area Soil Survey Leader with the USDA Natural Resources Conservation Service at the Tucson Soil Survey in Tucson, AZ. He has a B.S. degree in soil science from the University of Arizona. He started working with the Soil Conservation Service as a Soil Scientist making soil surveys in 1979.

In: McClaran, Mitchel P.; Ffolliott, Peter F.; Edminster, Carleton B., tech. coords. Santa Rita Experimental Range: 100 years (1903 to 2003) of accomplishments and contributions; conference proceedings; 2003 October 30–November 1; Tucson, AZ. Proc. RMRS-P-30. Ogden, UT: U.S. Department of Agriculture, Forest Service, Rocky Mountain Research Station.

(SRER) all factors are important; however, the time and parent material factors are particularly important. Most SRER soils are formed in alluvium of mixed origins, derived from igneous and sedimentary rocks (mostly granite and limestone), and these materials then experienced different time periods for soil development to occur. It is particularly useful to identify what are called "geomorphic surfaces" (Ely and Baker 1985; McAuliffe 1995 a,b; Peterson 1981), as they are closely related to soil characteristics.

A "geomorphic surface" is a mappable landscape element formed during a discrete time period, which has distinctive geologic materials, topographic features, and soil profiles. From this definition, it can be inferred that each stable surface will have a soil developed upon it, which has properties that are in part a function of the time since erosion and/or deposition has ceased. Quantifying pedogenic properties of soils on different geomorphic surfaces provides a means to compare the age of surfaces. On the SRER, soil texture, the color (amount of redness) of the soil, presence or absence of carbonates in the parent material, and soil horizons distinguish the soil series mapped on the SRER.

Significant relationships between soil properties and the spectral reflectance of soils in the visible and near-infrared portions of the electromagnetic spectrum (Baumgardner and others 1985; Condit 1970; DaCosta 1979; Shields and others 1968; Stoner 1979; Stoner and Baumgardner 1981) show it is possible to use remote sensing techniques to quantify soil properties. These researchers emphasized how the soil components of organic carbon, iron oxides, texture, water, and salts affect spectral reflectance. Correlations with Munsell hue, value, and chroma were also presented, but the color measurements were made using only the visual comparison procedure (Soil Survey Division Staff 1993). Escadafal and others (1988, 1989) investigated the relationships between Munsell soil colors and Landsat spectral response, especially on arid landscapes, and reported that the Munsell color parameters of hue, value, and chroma were significantly correlated with Landsat data. Post and others (1994) and Horvath and others (1984) concluded that the reflectance of radiant energy from sparsely vegetated arid rangelands is determined by the characteristics of the soil and geologic material on the land surface. They also concluded colorimeters to accurately quantify the color of earth surface features are very important for evaluating remotely sensed data. Other researchers (Bowers and Hanks 1965; Cipra and others 1980; Huete and Escadafal 1991; Weismiller and Kaminsky 1978; Westin and Lemme 1978) report how remotely sensed spectral data can be used to characterize and map soils.

There is a keen interest in understanding how incoming solar radiation from the sun is absorbed at the earth's surface. The ratio of the energy reflected back to the atmosphere is called the albedo of that surface. When discussing albedo the spectral wavelength must be identified, and commonly an integration of the amounts of energy reflected between 0.3 to 2.8 μm is used. Post and others (2000) described how albedo of soils can be predicted from soil color and spectral reflectance and how the albedo of SRER soils will be evaluated.

The objectives of this paper were to (1) collect samples of soil series mapped on different geomorphic surfaces with different kinds of alluvial parent materials and measure

their spectral reflectance, (2) measure the morphological properties of these soils, and (3) correlate soil reflectance in selected spectral bands to soil properties. Identification of basic spectral curves of the soil series found on the SRER would be useful for improved interpretation of remotely sensed data acquired by airborne sensors and orbiting satellites.

Materials and Methods

Thirty soil samples were collected from 16 different locations from six SRER geomorphic surfaces. The A and B horizons were sampled for mature soils; however, only the A horizon was collected from the Holocene age soils, except for one site where a C horizon was also collected. The samples were selected to encompass the range of soil reflectances that are found on the SRER. Multiple sample sites were selected for three soil series because these soils had a wider range of soil physical properties within these soil series.

All samples were air dried and passed through a 2-mm sieve, and all analyses were completed with the less than 2-mm soil fraction. Soil color was measured using a Model 200 Chroma Meter (Minolta Company) as follows: the samples were evenly distributed on a flat surface to provide a thickness of about 2 mm, the measuring head was rested in a vertical position on the soil surface, and a color reading was taken. A detailed description of this procedure and how the hue color notation was converted to a number for statistical analyses is described by Post and others (1993). The three Munsell color components were also converted into a redness rating as follows (Torrent and others 1980):

$$\text{Redness} = \frac{(10 - \text{hue}) \times \text{chroma}}{\text{Value}}$$

where the chroma and value are numerical values of each, and the hue is the notation number preceding the YR in the Munsell color notation system. Organic and inorganic carbon (C) contents were measured using a dry combustion method (TOC-VCSH, Total Carbon Analyser, made by Shimadzu Corporation, Columbia, MD). The samples were heated to 300 and 800 °C, and the CO₂ evolved at these two temperatures were measured by an infrared detector. The percent C released was converted to percent Organic Carbon (O.C.) and percent calcium carbonate (CaCO₃) found in each soil. Soil texture characteristics were determined by the "Field or Feel Method" (Thien 1978) by two field soil scientists, a mean percent clay and sand was calculated, and then the textural class was identified. Also, how the soil reacts when 10 percent HCL is applied to the sample (Soil Survey Division Staff 1993) was observed and recorded. The amount of effervescence refers to the amount of bubbles (CO₂) released, and terms like "slight," "strong," and "violent" are used to describe the reaction.

The reflectance spectra of these soils were recorded between the 0.4 to 2.5 μm wavelengths region at one nanometer increments using an Analytical Spectral Device full range hyperspectral system with a 15° field of view. Smooth soil surfaces were viewed vertically from a height of 0.5 m, and the reflected energy was referenced to a calibrated standard reflectance plate. The spectra were measured on a clear, cloud-free day in Tucson, AZ, between 11:00 and 11:30 a.m. on April 16, 2003. Reflectance data of special interest to

us were the Landsat Thematic mapper (TM) bands, namely TM1 (blue, 0.45 to 0.52 μm), TM2 (green, 0.52 to 0.60 μm), TM3 (red, 0.63 to 0.69 μm), TM 4 and 5 (near infrared [NIR] 0.76 to 0.90 and 1.55 to 1.75 μm), and TM 7 (middle infrared [MIR], 2.08 to 2.35 μm). A mean reflectance factor for each band was computed for the following wavelengths: blue = 0.485 μm , green = 0.560 μm , red = 0.660 μm , NIR = 0.830 μm , near short wave infrared = 1.650 μm , and middle infrared = 2.180 μm . These reflectance factors were correlated with the soil morphology properties for the 16 A horizons, 13 B horizons, and one C horizon for a total of 30 samples. The

correlation coefficient (r value) was computed and reported (Gomez and Gomez 1984).

Results and Discussion

The Soil and Ecological Site Map of the SRER prepared by Breckenfeld and Robinett (these proceedings) was the basic map used to prepare a general geomorphology map of the SRER and to determine where soil samples were to be collected. Figure 1 is a map outlining seven geomorphic surfaces on the SRER, and table 1 defines the terms that

Figure 1—Geomorphology land form surfaces map and the soil sample location sites collected on the Santa Rita Experimental Range.

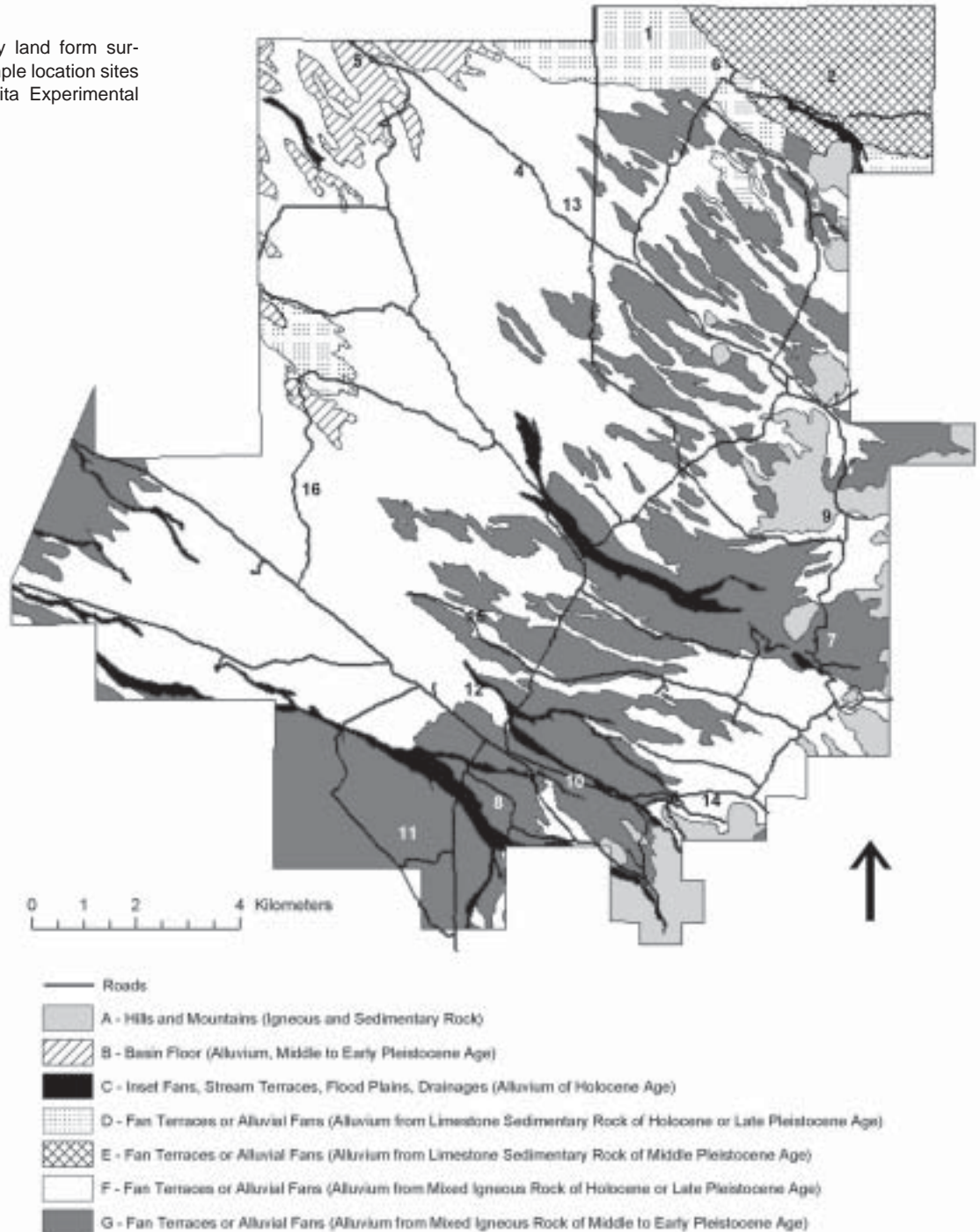

Table 1—Description of the geomorphic land form surfaces and geologic terms to define their age as identified on the SRER listed in alphabetical order.**Geomorphic surfaces**

Alluvial fan	A low, outspreading mass of loose soil and rock material, commonly with gentle slopes that are shaped like an open fan or a segment of a cone, deposited by water at the place where it issues from mountains.
Basin floor	A general term for the nearly level, lower most part of intermontane basins. The floor includes all the alluvial, eolian, and erosional land forms below the piedmont slope.
Fan terrace	A general term for land forms that are remaining parts of older fan B land forms, such as alluvial fan (fan remnant is another term used to describe this land form).
Flood plain	The nearly level A plain that borders a stream and is subject to inundation under flood-stage conditions (unless it is protected artificially).
Hills and mountains	A hill is an area of land surface, rising as much as 300 m above the surrounding lowlands, whereas a mountain rises more than 300 m.
Inset fan	An ephemeral stream flood plain rather broad in area incised in alluvial fans or fan terraces; a barren channel covers a minor portion of its surface, but its breadth is rather extensive.
Piedmont slope	The dominant gentle slope at the foot of a mountain that grades to a basin floor or alluvial flood plains.
Stream terraces	One of a series of levels in a stream valley that mostly parallels the stream, but it no longer floods.

Geologic terms to define the age of geomorphic surfaces

Holocene	The geologic time period extending from the end of the Pleistocene (Ice Age) Epoch from 10,000 to 12,000 years before present.
Pleistocene	The epoch of geologic time referred to as the Quaternary Period with a geologic time from approximately 2 million to 10,000–12,000 years before present.
Late Pleistocene	10,000–12,000 to 25,000 years before present.
Middle Pleistocene	25,000 to 300,000 or 400,000 years before present.
Early Pleistocene	300,000 or 400,000 to 1,000,000–2,000,000 years before present.

describe these surfaces. Figures 2 and 3 present the spectral curves for representative A and B horizons, respectively. Table 2 lists the mean reflectance values for the 30 soils for six of the Thematic Mapper (TM) wavelength bands, and table 3 lists the soil morphology characteristics for the 30 soils.

Stoner (1979) and Stoner and Baumgardner (1981) describe in great detail the spectral characteristics for many soils. They explain that moisture content, organic matter, iron content, and presence of minerals such as calcium carbonate most determine soil color. The SRER soils have a

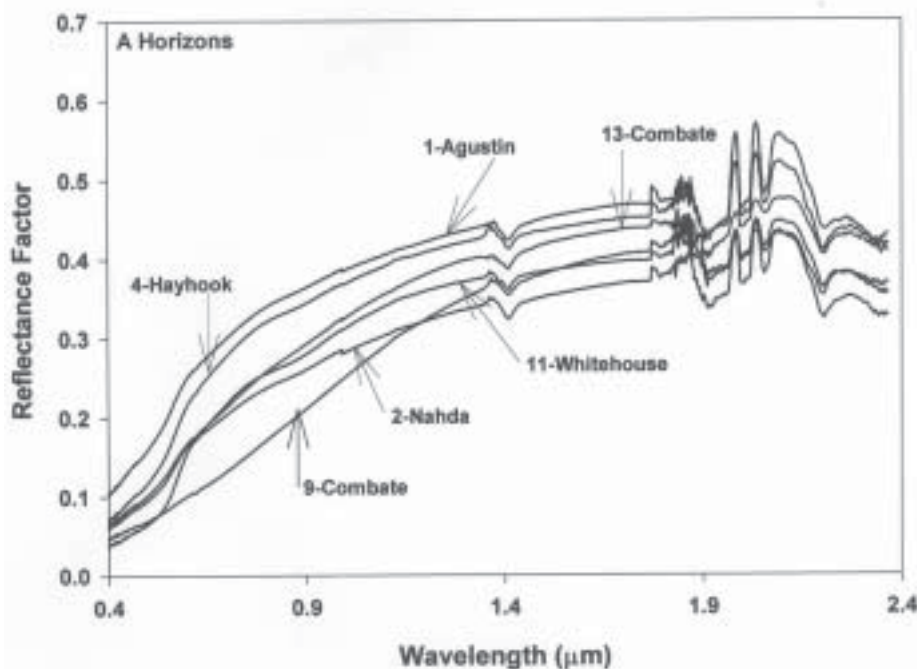
**Figure 2**—Spectral curves for A horizons of representative Santa Rita Experimental Range soils.

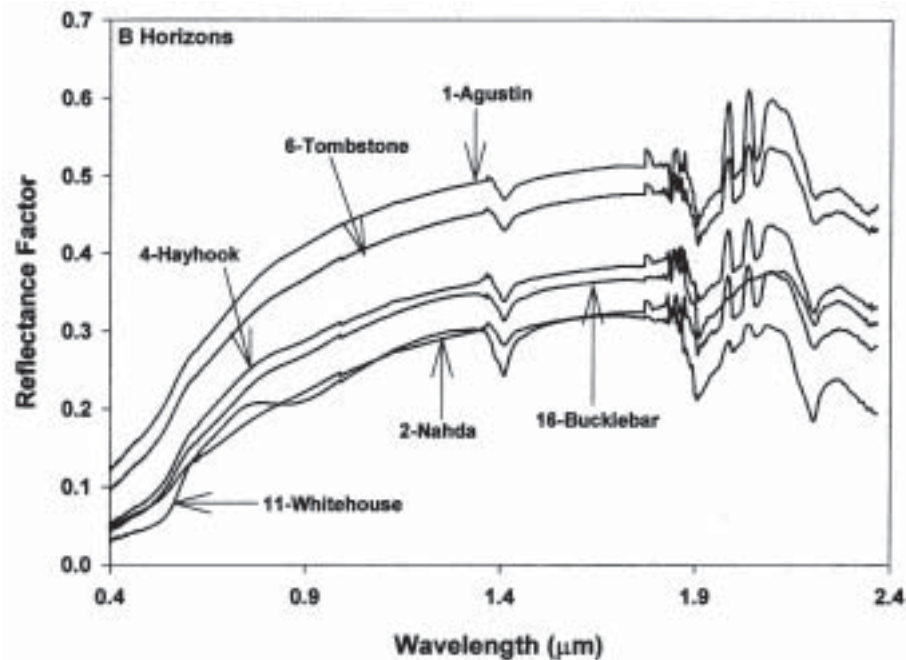

Figure 3—Spectral curves for B horizons of representative Santa Rita Experimental Range soils.

Table 2—Percentage of reflected energy in six selected wavelengths corresponding to the Landsat Thematic Mapper (TM) bands.

Soil ID	Soil names and horizons	Blue (0.485 mm)	Green (0.560mm)	Red (0.660mm)	NIR (0.830mm)	MIR (1.650mm)	MIR (2.179mm)
1	Agustin (A)	0.1521	0.2126	0.2823	0.3474	0.4634	0.4814
1	Agustin (Bk)	.1678	.2264	.2999	.3888	.5086	.5181
2	Nahda (A)	.0912	.1336	.1891	.2441	.3645	.3747
2	Nahda (Btk)	.0707	.1027	.1485	.2047	.3203	.3237
3	Sasabe (A)	.0803	.1283	.2008	.2650	.4021	.4197
3	Sasabe (Bt)	.0619	.0976	.1597	.2247	.3544	.3536
4	Hayhook (A)	.1110	.1718	.2565	.3278	.4464	.4611
4	Hayhook (Bw)	.0802	.1267	.1999	.2724	.3796	.3782
5	Tubac (A)	.0947	.1492	.2303	.3021	.4205	.4288
5	Tubac (Bt)	.0681	.1129	.1954	.2633	.3582	.3364
6	Tombstone (A)	.1326	.1875	.2549	.3262	.4612	.4734
6	Tombstone (Bk)	.1381	.1940	.2658	.3465	.4716	.4792
7	Whitehouse (A)	.0950	.1581	.2549	.3246	.4466	.4435
7	Whitehouse (Bt)	.0522	.0856	.1592	.2211	.3335	.2962
8	Caralampi (A)	.1060	.1572	.2307	.2966	.3760	.3861
8	Caralampi (Bt)	.0779	.1204	.1887	.2496	.2927	.2794
9	Combate (A)	.0667	.0880	.1187	.1833	.3995	.4017
10	Whitehouse (A)	.0625	.1001	.1561	.2089	.3563	.3512
10	Whitehouse (Bt)	.0501	.0879	.1730	.2427	.3885	.3156
11	Whitehouse (A)	.0620	.1100	.1963	.2625	.3933	.3949
11	Whitehouse (Bt)	.0456	.0808	.1617	.2072	.3178	.2524
12	Combate (A)	.0832	.1189	.1640	.2326	.4265	.4244
12	Combate (C)	.1088	.1541	.2069	.2749	.4502	.4443
13	Combate (A)	.0970	.1392	.1955	.2684	.4323	.4416
14	Baboquivari (A)	.1023	.1567	.2304	.3131	.4560	.4376
14	Baboquivari (Bt)	.0759	.1179	.1815	.2567	.3953	.3620
15	Bucklebar (A)	.1053	.1646	.2514	.3301	.4393	.4374
15	Bucklebar (Bt)	.0798	.1249	.1962	.2656	.3520	.3429
16	Bucklebar (A)	.1027	.1603	.2373	.3167	.4465	.4369
16	Bucklebar (Bt)	.0696	.1136	.1778	.2523	.3628	.3465

Table 3—Soil morphology characteristics of the thirty soils sampled on the Santa Rita Experimental Range.

Soil ID	Geomorphic Surface ^a	Soil names and Horizons	Munsell soil color				Redness rating	Organic		Clay	Sand	Effer ^b	Albedo
			Hue	Hue	Value	Chroma		carbon	CaCO ₃				
								 percent.....				
1	D	Agustin (A)	9.5 YR	4.8	6.1	3.6	0.3	0.49	13.7	10	73	3.2	0.31
1	D	Agustin (Bk)	9.0 YR	4.6	6.0	3.2	.5	.59	19.4	18	69	3.8	.30
2	E	Nahda (A)	8.7 YR	4.5	4.8	3.4	.9	.71	.0	18	63	.0	.22
2	E	Nahda (Btk)	8.2 YR	4.3	4.2	3.2	1.4	.92	.7	32	50	.4	.18
3	G	Sasabe (A)	7.2 YR	3.9	4.8	4.4	2.6	.48	.0	13	67	.0	.22
3	G	Sasabe (Bt)	6.0 YR	3.4	4.2	4.3	4.0	.46	.0	30	57	.2	.18
4	F	Hayhook (A)	8.0 YR	4.2	5.5	4.4	1.6	.34	.0	10	75	.0	.27
4	F	Hayhook (Bw)	7.5 YR	4	4.6	4.1	2.3	.32	.0	16	70	.0	.20
5	B	Tubac (A)	7.5 YR	4	5.2	4.5	2.2	.29	.0	9	78	.0	.24
5	B	Tubac (Bt)	5.5 YR	3.2	4.5	4.9	5.0	.21	.0	42	41	.0	.19
6	D	Tombstone (A)	9.7 YR	4.9	5.5	3.4	.2	.80	7.6	12	68	3.8	.27
6	D	Tombstone (Bk)	8.7 YR	4.5	5.7	3.5	.8	.52	7.8	15	69	3.8	.28
7	G	Whitehouse (A)	7.0 YR	3.8	5.2	4.7	2.7	.52	.0	8	76	.0	.24
7	G	Whitehouse (Bt)	4.2 YR	2.7	3.8	4.7	7.2	.94	.0	47	30	.0	.15
8	G	Caralampi (A)	8.2 YR	4.3	5.2	3.8	1.3	1.00	.0	9	67	.0	.24
8	G	Caralampi (Bt)	6.7 YR	3.7	4.2	3.9	3.0	.71	.0	35	52	.0	.18
9	F	Combate (A)	9.7 YR	4.9	3.9	1.9	.1	.89	.0	5	87	.0	.16
10	G	Whitehouse (A)	7.2 YR	3.9	4.2	3.9	2.6	.84	.0	17	69	.0	.18
10	G	Whitehouse (Bt)	4.0 YR	2.6	4.1	5.3	7.7	.68	.0	48	40	.0	.17
11	G	Whitehouse (A)	5.7 YR	3.3	4.4	4.9	4.9	.92	.0	14	58	.0	.19
11	G	Whitehouse (Bt)	3.2 YR	2.3	3.9	5.2	9.1	.69	.0	53	25	.0	.16
12	C	Combate (A)	10.0 YR	5	4.6	2.7	.0	.62	.0	7	85	.0	.20
12	C	Combate (C)	10.0 YR	5	5.1	3.0	.0	.43	.9	5	89	1.5	.23
13	F	Combate (A)	9.0 YR	4.6	4.8	3.2	.7	.38	.0	8	85	.0	.22
14	F	Baboquivari (A)	9.0 YR	4.6	5.3	3.9	.7	.80	.0	8	76	.0	.25
14	F	Baboquivari (Bt)	7.7 YR	4.1	4.6	3.8	1.9	.53	.0	25	64	.0	.20
15	F	Bucklebar (A)	7.7 YR	4.1	5.4	4.3	1.8	.49	.0	9	72	.0	.26
15	F	Bucklebar (Bt)	7.0 YR	3.8	4.8	4.0	2.5	.32	.0	15	70	.0	.22
16	F	Bucklebar (A)	8.7 YR	4.5	5.2	4.0	1.0	.99	.0	12	71	.0	.24
16	F	Bucklebar (Bt)	8.0 YR	4.2	4.5	3.9	1.7	.30	.0	25	63	.0	.19

^a Refer to figure 1 and table 1 for descriptions of geomorphic surfaces.

^b Effervescence: 0 = none, 1 = slight, 2 = moderate, 3 = strong, 4 = violent.

low organic matter. Content and the older land surfaces, particularly the Whitehouse soil series, are very red, indicating the presence of iron oxide in the soil. It also has a clay texture which occurs as soils get older. Although we did not measure the iron content of the SRER soils, we did compute the redness index, which is indicative of the iron content (particularly Fe₂O₃ – ferric iron) in a soil.

The spectral curves for the A horizons show that Combate (9) has the lowest reflectance factor in the 0.4 to 1.0 mm wavelength range (fig. 2). This soil also has a color value of 3.9, the lowest of all soils. The Agustin (1) soil has the highest reflectance factor, and it also has the highest Munsell color value of 6.1. The Agustin soil has about 14 percent CaCO₃, which contributes to the lighter color and higher Munsell value. Other representative soil curves for the Hayhook, Whitehouse, Nahda, and a second Combate sample are shown to illustrate the range in spectral characteristics of the A horizons mapped on the SRER.

Figure 3 presents the spectral curves for the B horizons. The Agustin soil is the most reflective, and the Tombstone soil has the next highest reflectance. Both of these soils are formed from alluvium derived from limestone parent materials. The Whitehouse Bt horizon is very red (redness rating

of 9.1), and the shape of the spectral curve shows the presence of iron in this soil. The iron absorption occurs in the 0.5 to 0.9 mm band width. The Bucklebar and Hayhook soils have intermediate spectral reflectance characteristics. The Nahda Btk horizon reflectance is similar to the Whitehouse Bt horizon, but the curve shape is different because the Nahda soil is less red and likely has a lower iron content.

The spectral curves for both the A and B horizons from 1.0 mm to 2.5 mm show very strong absorptions at about 1.9 mm, and a less pronounced absorption band at 1.4 mm. There are striking other differences in reflected energy in the 1.0 to 2.5 mm bands, which are mostly water or hydroxyl absorption bands. Spectral data in the visible and NIR are commonly used to classify the reflectance properties of land surfaces because orbiting satellites collect data in these wavelengths, and this is of most interest to us.

Table 4 lists the linear relationships, expressed as the correlation coefficient > r value =, for the mean reflectances of six TM bands and soil morphology properties. The correlations were determined for the A and B horizons, and all 30 samples including one C horizon sample. The significance of each correlation is noted in the table for P ≤ 0.05 and P ≤ 0.01, with one and two asterisks, respectively.

Table 4—Correlations between Landsat Thematic Mapper wavelengths and soil morphology properties for the A, B, and all horizons combined.

	Blue (0.485)	Green (0.560)	Red (0.660)	NIR (0.830)	MIR (1.650)	MIR (2.180)
A horizons (n = 16). P ≤ 0.05^a (r > 0.5) and P ≤ 0.01^b (r > 0.62)						
Redness rating	-0.50 ^a	-0.29	0.02	-0.01	-0.35	-0.36
Percent organic carbon	-0.26	-0.30	-0.32	-0.32	-0.36	-0.48
Percent calcium carbonate	0.76 ^b	0.66 ^b	0.48	0.43	0.45	0.57
Percent clay	-0.17	-0.12	-0.05	-0.14	-0.52 ^a	-0.47
Percent sand	0.0	-0.12	-0.26	-0.19	0.35	0.30
Hue	0.43	0.21	-0.10	-0.06	0.35	0.35
Value	0.93 ^b	0.99 ^b	0.95 ^b	0.94 ^b	0.69 ^b	0.75 ^b
Chroma	0.02	0.27	0.56 ^a	0.54 ^a	0.09	0.08
Effervescence	0.73 ^b	0.63 ^b	0.46	0.42	0.47	0.57 ^a
B Horizons (n = 13). P ≤ 0.05^a (r > 0.55) and P ≤ 0.01^b (r > 0.68)						
Redness rating	-0.70 ^b	-0.69 ^b	-0.53	-0.58 ^a	-0.46	-0.69 ^b
Percent organic carbon	-0.14	-0.20	-0.26	-0.30	-0.23	-0.28
Percent calcium carbonate	0.92 ^b	0.90 ^b	0.89 ^b	0.87 ^b	0.83 ^b	0.84 ^b
Percent clay	-0.68 ^b	-0.70 ^b	-0.59 ^a	-0.63 ^a	-0.54	-0.73 ^b
Percent sand	0.65 ^a	0.67 ^a	0.57 ^a	0.63 ^a	0.55 ^a	0.71 ^b
Hue	0.75 ^b	0.74 ^b	0.59 ^a	0.63 ^a	0.53	0.74 ^b
Value	0.97 ^b	0.98 ^b	0.95 ^b	0.96 ^b	0.88 ^b	0.95 ^b
Chroma	-0.70 ^b	-0.66 ^a	-0.47	-0.49	-0.39	-0.62 ^a
Effervescence	0.93 ^b	0.91 ^b	0.89 ^b	0.87 ^b	0.85 ^b	0.88 ^b
All Horizons (n = 30). P ≤ 0.05^a (r > 0.36) and P ≤ 0.01^b (r > 0.46)						
Redness rating	-0.67 ^b	-0.62 ^b	-0.38 ^a	-0.41 ^a	-0.57 ^b	-0.72 ^b
Percent organic carbon	-0.13	-0.17	-0.22	-0.24	-0.15	-0.16
Percent calcium carbonate	0.79 ^b	0.73 ^b	0.64 ^b	0.63 ^b	0.57 ^b	0.56 ^b
Percent clay	-0.57 ^b	-0.57 ^b	-0.43 ^a	-0.46 ^b	-0.66 ^b	-0.80 ^b
Percent sand	0.52 ^b	0.50 ^b	0.32	0.37 ^a	0.65 ^b	0.75 ^b
Hue	0.67 ^b	0.60 ^b	0.35	0.38 ^a	0.61 ^b	0.73 ^b
Value	0.95 ^b	0.98 ^b	0.94 ^b	0.94 ^b	0.82 ^b	0.86 ^b
Chroma	-0.39 ^a	-0.25	0.06	0.03	-0.28	-0.40 ^a
Effervescence	0.79 ^b	0.72 ^b	0.62 ^b	0.60 ^b	0.59 ^b	0.59 ^b

^a Correlation significance P ≤ 0.05.^b Correlation significance P ≤ 0.01.

For all three groups, there was a very significant correlation with Munsell value, and the r values ranged from 0.93 to 0.99 for the visible and NIR bands. For the middle NIR and the MIR bands the r values were lower, and they ranged from 0.69 to 0.95, and were lowest for the A horizons. For the A horizons, the percent CaCO₃ and effervescence had the next strongest correlations to reflectance in the blue and green bands, but they were less important in the other bands. Munsell chroma was significantly correlated in the red and NIR bands.

There were many significant correlations identified for the B horizons and for all 30 samples. Munsell value, percent CaCO₃, and effervescence were again most strongly correlated, but other soil morphology properties like Munsell hue and chroma, redness rating, and percent clay and sand were also significantly correlated. The only soil morphology property that was not correlated to reflectance was percent organic carbon. Organic carbon is a very important factor in other soils, but the low percent of organic carbon in SRER soils showed that it did not significantly affect reflectance.

Post reported that soil albedo in the 0.3 to 2.8 mm can be computed using the Munsell color value as follows: Soil Albedo = 0.069 (color value) - 0.114. Using this equation the albedos of SRER soils (A horizon) would range from 0.155 for the Combate (9) to 0.307 for the Agustin, and are presented in table 3.

Summary

The range of spectral characteristics of the SRER soils were presented, and these data will be useful as researchers complete remote sensing projects on the SRER. The geomorphology map compiled from the basic soils and ecological site map helps us to better understand the soil-forming factors responsible for the formation of the SRER soils. What soil morphology characteristics determine the reflectance characteristics of SRER soils have been identified, and the Munsell color value component is the most important, particularly in the 0.4 to 1.0 mm wavelengths. The range of soil properties for the A and B horizons have been measured, and these data will be helpful in understanding the biophysical conditions that exist on the SRER.

References

- Baumgardner, M. F.; Silva, L. F.; Biehl, L. L.; Stoner, E. R. 1985. Reflectance properties of soils. *Advance Agronomy*. 38: 1-44.
- Bowers, S. A.; Hanks, R. J. 1965. Reflection of radiant energy from soils. *Soil Science*. 100: 130-138.
- Cipra, J.; Franzmeier, D. P.; Bauer, M. E.; Boyd, R. K. 1980. Comparison of multispectral measurements from some nonvegetated soils using Landsat digital data and a spectroradiometer. *Soil Science Society of America Journal*. 44: 80-84.

- Condit, H. R. 1970. The spectral reflectance of American soils. *Photogrammetric Engineering*. 36: 955–966.
- DaCosta, L. M. 1979. Surface soil color and reflectance as related to physico-chemical and mineralogical soil properties. Columbia: University of Missouri. Dissertation Abstract 80-24350.
- Ely, L. L.; Baker, V. R. 1985. Geomorphic surfaces in the Tucson Basin, Arizona. Field guidebook for workshop on global megageomorphology, January 1985. University of Arizona, Department of Geosciences.
- Escadafal, R.; Girard, M. C.; Courault, D. 1988. Modeling the relationship between Munsell soil color and soil spectral properties. *International Agrophysics*. 4(3): 249–261.
- Escadafal, R.; Girard, M. C.; Courault, D. 1989. Munsell soil color and soil reflectance in the visible spectral bands of Landsat MSS and TM data. *Remote Sensing of Environment*. 27: 37–46.
- Gomez, K. A.; Gomez, A. A. 1984. Statistical procedures for agricultural research. 2d ed. Wiley-Interscience Publications. 680 p.
- Horvath, E. H.; Post, D. F.; Kelsey, J. B. 1984. Relationships among Landsat digital data and the properties of Arizona rangelands. *Soil Science Society of America Journal*. 48: 1331–1334.
- Huete, A. R.; Escadafal, R. 1991. Assessment of biophysical soil properties through spectral decomposition techniques. *Remote Sensing of Environment*. 35: 149–159.
- Jenny, Hans. 1941. Factors of soil formation. New York: McGraw-Hill. 281 p.
- Jenny, Hans. 1980. The soil resource-origin and behavior. New York: Springer-Verlag. 270 p.
- McAuliffe, J. R. 1995a. Landscape evolution, soil formation, and Arizona desert grass lands. In: McClaran, M. P.; Van Devender, T. R., eds. *The desert grassland*. Tucson: University of Arizona Press.
- McAuliffe, J. R. 1995b. Landscape evolution, soil formation, and ecological patterns and processes in Sonoran Desert bajadas. *Ecological Monographs*. 64: 111–148.
- Peterson, F. F. 1981. Land forms of the Basin and Range Province defined for soil survey. Tech. Bull. 28. Reno: University of Nevada, Nevada Agriculture Experiment Station.
- Post, D. F.; Levine, S. J.; Bryant, R. B.; Mays, M. D.; Batchily, A. K.; Escadafal, R.; Huete, A. R. 1993. Correlations between field and laboratory measurements of soil color. In: Bigham, J. M.; Ciolkosz, E. J., eds. *Soil color*. Spec. Publ. 31. Madison, WI: SSSA: 35–49.
- Post, D. F.; Lucas, W. M.; White, S. A.; Ehasz, M. J.; Batchily, A. K. 1994. Relations between soil color and landsat reflectance on semiarid rangelands. *Soil Science Society of America Journal*. 58: 1809–1816.
- Post, D. F.; Fimbres, A.; Mathias, A. D.; Sano, E. E.; Accioly, L.; Batchily, A. K.; Ferreira, L. G. 2000. Predicting soil albedo from soil color and spectral reflectance data. *Soil Science Society of America Journal*. 64: 1027–1034.
- Shields, J. A.; Paul, E. A.; St. Arnaud, R. J.; Head, W. K. 1968. Spectrophotometric measurement of soil color and its relationship to moisture and organic matter. *Canada Journal of Soil Science*. 48: 271–280.
- Soil Survey Division Staff. 1993. Soil survey manual. USDA-SCS Agric. Handb. 18. Washington, DC: U.S. Government Printing Office.
- Stoner, E. R. 1979. Atlas of soil reflectance properties. Result Bull. 962. West Lafayette, IN: Purdue University, Agriculture Experiment Station.
- Stoner, E. R.; Baumgardner, M. F. 1981. Characteristic variations in reflectance of surface soils. *Soil Science Society of America Journal*. 45: 1161–1165.
- Thien, S. J. 1978. A flow diagram for teaching texture-by-field analysis. *Journal of Agronomic Ed*: 54–55.
- Torrent, J.; Schwertmann, U.; Schulze, D. G. 1980. Iron oxide mineralogy of some soils of two river terrace sequences in Spain. *Geoderma*. 23: 191–208.
- Weismiller, R. A.; Kaminsky, S. A. . 1978. Application of remote sensing technology to soil survey/research. *Journal of Soil and Water Conservation*. 33: 287–289.
- Westin, F. C.; Lemme, G. D. 1978. Landsat spectral signatures: studies with soil associations and vegetation. *Photogrammetric Engineering and Remote Sensing*. 44: 315–325.

Cow Weights and Calf Production for Pasture 12-C Lehmann Lovegrass Grazing Trials, 1982 to 1993

Abstract: The purpose of the grazing trials described in this paper was to provide information to aid in the development of grazing management strategies where Lehmann lovegrass has become a dominant species. Seven pastures were utilized from 1984 to 1987 for a comparison of four yearlong stocking rates to seasonal grazing rotated through three pastures. A second trial, 1988 to 1993, rotated cows and calves through all pastures at a very low stocking rate. Spot grazing created patchy grazing patterns that persisted throughout the study period on all treatment pastures, except the yearlong very heavy stocking and summer-use rotation pastures. Weaned calf production for all treatments (especially the rotated treatment) tended to decrease in the last 2 years of the 1984 to 1987 trial because cows slipped to later breeding and poorer percentage calf crops. Cows selected for limited high quality forage, especially in winter and spring, from the heavily grazed patch areas, and repeated heavy grazing reduced the potential quantity of forage produced in these patches. A two-pasture, alternate summer use, with both pastures grazed during winter and spring, is suggested as a possible grazing system to maintain favorable calf production and a sustainable range resource.

Keywords: Lehmann lovegrass, grazing trial, stocking rate, pasture rotation, cow weight, patch grazing

Acknowledgments: The research from which the data reported in this paper were obtained was planned, funded, implemented, and conducted as a cooperative effort among the Department of Animal Science and School of Renewable Natural Resources, University of Arizona; William A. McGibbon, Santa Rita Ranch; and USDA Forest Service, Rocky Mountain Forest and Range Experiment Station.

The precipitation data for Station 41 reported in table 1 were provided by the Santa Rita Experimental Range Digital Database. Funding for the digitization of these data was provided by USDA Forest Service, Rocky Mountain Research Station, and the University of Arizona.

Introduction

This paper is written as a printed version of a poster presentation. Each section of the paper is written as text associated with a figure or table, as displayed on a poster. No review of literature is included.

Eragrostis lehmanniana Nees. (Lehmann lovegrass) has become a dominant species on many ecological sites in southern Arizona, and strategies for management of these sites are not well established. This paper adds livestock production and utilization pattern data to the management information base.

Water Source and Site Characteristics

Implementation of the grazing trials began in the spring of 1982, with the installation of 2 miles of water line from Benson Wells to a storage tank installed near the center of pasture 12-C. The PVC pipe was bedded in soil free of large rocks (fig. 1)

Phil R. Ogden is retired; e-mail: pro29@cox.net. At the time of the research reported in this paper, he was Professor of range management and Extension Range Management Specialist, University of Arizona. He completed B.S. and M.S. degrees in range management at Utah State University and a Ph.D. degree in plant physiology at Iowa State University. Lamar Smith is a Rancher and Range Management Consultant. At the time of the research reported in this paper, he was Associate Professor of range management at the University of Arizona. He has B.S. and M.S. degrees in range management and a Ph.D. degree in soil science from Colorado State University.

In: McClaran, Mitchell P.; Ffolliott, Peter F.; Edminster, Carleton B., tech. coords. Santa Rita Experimental Range: 100 years (1903 to 2003) of accomplishments and contributions; conference proceedings; 2003 October 30–November 1; Tucson, AZ. Proc. RMRS-P-30. Ogden, UT: U.S. Department of Agriculture, Forest Service, Rocky Mountain Research Station.



Figure 1—Bedding water line across a loamy upland ecological site dominated by Lehmann lovegrass, spring 1982.

prior to covering by a grader. Figure 1 also provides a view of the loamy upland ecological site on a Whitehouse soil series that dominates the study area. Sampling on this site in 1980 estimated 1,500 pounds per acre standing biomass. Sampling on monitoring plots in 1984 estimated 2,250 pounds per acre standing biomass with a vegetation composition of Lehmann lovegrass, 69 percent; *Calliandra eriophylla* Benth. (false mesquite), 25 percent; grama grass group: *Bouteloua chondrosioides* (H.B.K.) Benth. (sprucetop), *B. hirsuta* Lag. (hairy), and *B. repens* (H.B.K.) Scribn. & Merr. (slender), 3 percent; and other species, 2 percent. The slopes of the draws that drain these uplands had 700 pounds per acre standing biomass and vegetative composition of Lehmann lovegrass, 9 percent; false mesquite, 16 percent; grama grass group, 55 percent; and other species, 12 percent.

Precipitation

Seasonal precipitation for the forage production year summarized in table 1 includes precipitation in October, November, and December from the previous calendar year, as this precipitation is a major factor contributing to this production. Precipitation in 1983 and 1984 was very favorable, especially in summer. These 2 years of very favorable precipitation led to optimistic estimates for stocking rates for this grazing trial. Precipitation was lower over the next 3 years, but no years during the trial period were drought years. Precipitation Station 41 is located near the center of the study pastures.

Pasture Layout

Two-wire electric fences for an initial six pastures and water troughs at the center of the pastures were completed by fall 1982. At this time, 118 cows were allocated to the pastures to test three intensities of yearlong grazing and a seasonal treatment with one herd rotated among three pastures. Corrals and working facilities to accommodate scales, calf table, and loading chute were completed in 1983.

Table 1—Seasonal precipitation (inches), Station 41, Santa Rita Experimental Range, fall 1980 to summer 1993.

Forage production year	Season			Total
	October to January	February to May	June to September	
1981 ^a	2.70	3.94	10.71	17.35
1982	2.19	1.82	8.90	12.91
1983	5.79	4.03	12.27	22.09
1984	7.92	1.77	22.65	32.34
1985	8.45	2.56	7.96	18.97
1986	3.54	3.51	8.07	15.12
1987	3.66	4.25	5.39	13.30
1988	5.65	2.52	9.91	18.08
1989	5.76	1.53	6.44	13.73
1990	5.42	1.92	15.56	22.90
1991	3.59	3.92	4.77	12.28
1992	4.46	5.08	11.87	21.41
1993	7.30	4.21	9.65	21.16
Mean	5.11	3.16	10.32	18.59

^a October, November, and December precipitation is for previous calendar year.

After fall roundup in 1983, the grazing trial design was modified to add a very heavy stocking intensity. Original pasture 4, which was to be a rotated pasture, was divided to make pastures 4 and 5 as shown in figure 2. Pasture 3 was exchanged with pasture 4 to be the summer rotation pasture. The holding pasture was not fenced until the winter of 1986 to 1987.

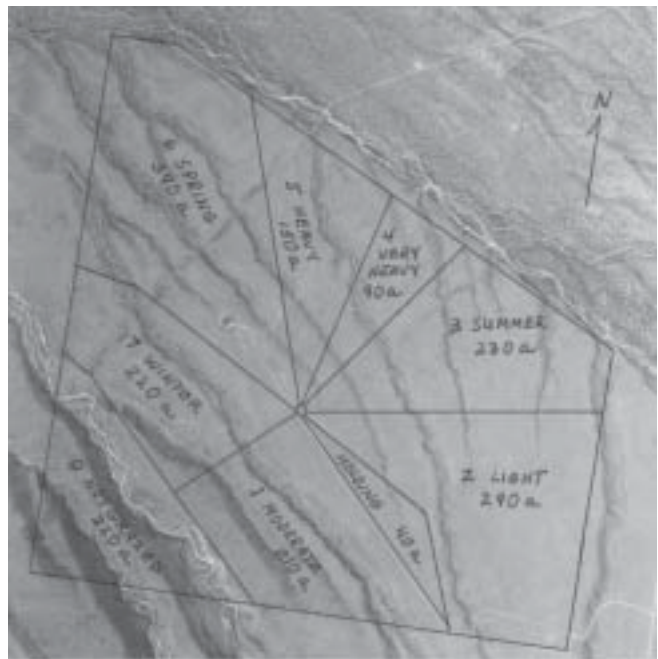

Figure 2—Pasture layout for Santa Rita Experimental Range pasture 12-C grazing trial, 1984 to 1993.

Data Collection and General Information

Cows were weighed, condition estimated, and calves were worked at the calf table (fig. 3) at spring roundup in mid-May to early June. At the fall roundup in early November of each year, cows and calves were weighed, cow condition was estimated, calves were weaned, and limited culling (to allow cumulative treatment effects to be expressed) and replacement of the cows was accomplished. Percentage of cows culled was 1.8 in 1984, 10.1 in 1985, 9.1 in 1986, and 37.5 at the end of the initial 4-year trial in November 1987. The annual percentage of cow death losses during the 1984 to 1987 trial were: 1.8 in 1984, 2.8 in 1985, no death loss in 1986, and 3.1 in 1987.

Stocking Intensity

Planned stocking rates for the 1984 to 1987 trial were initiated by assigning four cows and 16 bred heifers to pasture 2 (light use, 16 acres per animal unit year [AUY]), 18 cows to pasture 1 (moderate use, 12 acres per AUY), 15 cows to pasture 5 (heavy use, 10 acres per AUY), 13 cows to pasture 4 (very heavy use, 7 acres per AUY), and 49 cows to pastures 3, 6, and 7 (seasonally rotated, 17 acres per AUY for the total area of the three rotated pastures). Dates of seasonal pasture moves varied annually, but summer use was July to mid-November, winter use was mid-November to March, and spring use was from March to July. Following the 1984 to 1987 grazing trial, a second trial was initiated. The stocking rate was reduced to a very light use (31 acres per AUY), and cows were rotated annually through seven pastures until 1992 when they also grazed the previously ungrazed pasture 8. Calves were weighed at fall roundup.

Implemented stocking rates (fig. 4) varied from the initial allocation due to culling, death losses, and a few cows not staying in their assigned treatment pasture. The heavy stocking level became similar to the moderate stocking level at the beginning of the trial, as two cows assigned to the heavy treatment were missed in the initial roundup and



Figure 3—Working calves at the calf table during spring roundup.

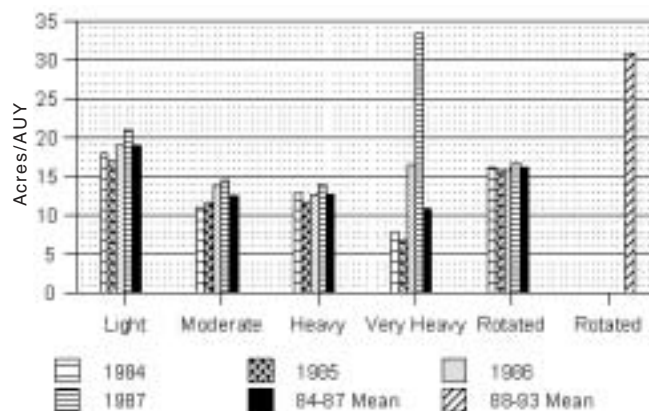

Figure 4—Stocking rate, acres per animal unit year.

remained in other pastures, and two cows in this treatment died early in the trial. These two treatments are similar in stocking rate as implemented, and are referred to as moderate to heavy in the following discussion. Implemented stocking rate data include bulls.

Cow Weights

Annual spring cow weight treatment means for 1985 to 1987 (cows were not weighed in the spring of 1984) generally varied between 800 and 900 lb, and coefficients of variation were near 10 percent (95-percent confidence intervals were on the order of +/- 50 pounds). Cow weights at the spring roundup were similar for all treatments. At fall roundup, cows in the moderate to heavy use treatments were the heaviest, averaging over 950 pounds (fig. 5). Cows in the very heavy use treatment and seasonal rotation averaged 900 lb, and the cows in the light use pasture averaged about 850 lb. The light cow weights for the light use treatment were due to a high proportion of first calf heifers assigned to this treatment at the beginning of the trial. Fall cow weights for all treatments except the very heavy intensity were higher in 1984 than for

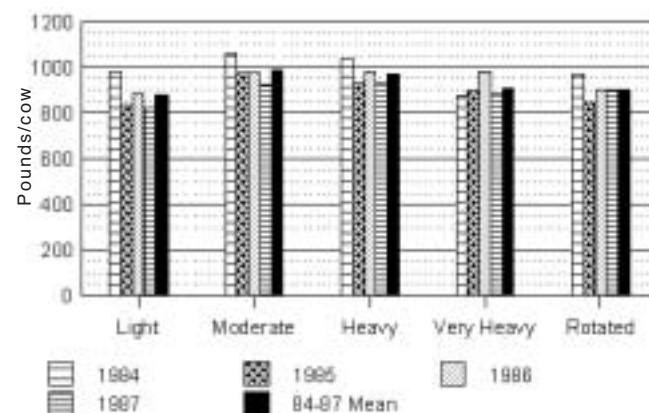

Figure 5—Cow weights at fall roundup, pounds per cow.

all other years, and this correlates with the extremely good summer precipitation in 1984 (table 1).

Weaned Calf Weights

Treatment mean weaned calf weights generally varied between 350 to 550 lb with coefficients of variation near 20-percent and 95-percent confidence intervals on the order of +/- 50 lb among treatments within years. Calves from the light use pasture weighed over 600 lb in 1984 (fig. 6). This high weight was a bias in the trial, as a result of the high proportion of first calf heifers assigned to this treatment. These heifers had been bred to calve earlier than the cows that were assigned to the grazing trial. The very heavy use treatment calf weights were lower in both 1984 and 1985 compared to the other treatments, and there was a trend to lighter weight calves in the later 2 years of the 1984 to 1987 trial for all other treatments.

Calf Production as Pounds Per Animal Unit Year

Calf pounds per AU (fig. 7) combine the effects of calf weight, percentage calf crop, and stocking rate. The low weaned calf pounds per AU the second year of the very heavy use treatment is very evident. Even with the very good precipitation years of 1983 and 1984, cows bred on the very heavy use pasture in 1984 had light calves in 1984 (fig. 6) and a 70-percent calf crop in 1985. Calf crops for the other treatments ranged from 85 to 100 percent in 1985. Cow numbers assigned to the very heavy treatment were reduced to seven cows in the fall of 1985. In 1986 and 1987 when forage in the very heavy use pasture became limited, these remaining cows were placed with and contributed to the calculated stocking rate of the rotated pastures, and the stocking rate of the heavy use pasture reduced accordingly.

The poorest mean calf pounds per AU for the 1984 to 1987 trial was for the seasonally rotated treatment. In addition to the trend to lighter calf weights in the later 2 years of the 1984 to 1987 trial, percentage calf crop in 1987 was 67, 64, and 72 percent for the light, moderate, and rotated treatments,

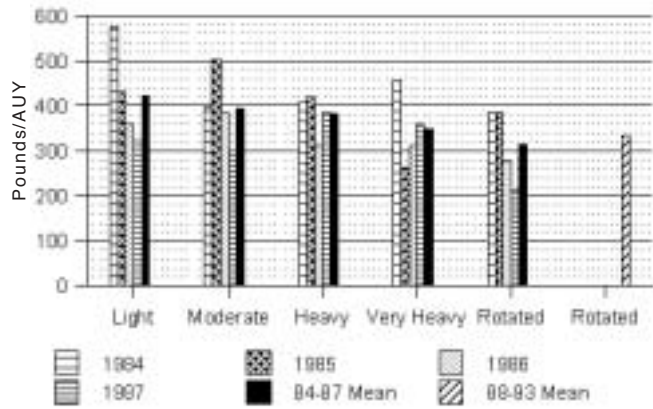

Figure 7—Calf weaning weights, pounds per animal unit year.

respectively. Progressively drier years, lack of nutritional forage to stimulate prompt breeding after calving, and limited culling during the 1984 to 1987 trial contributed to these results. Mean calf pounds per AU for the rotated treatment with very light stocking from 1988 to 1993 was slightly higher than the rotated treatment mean for the 1984 to 1987 trial.

Calf Production as Pounds Per Acre

The very heavy use treatment yielded high calf production per acre for 2 years and then was not sustainable (fig. 8). Weaned calf production for the yearlong moderate to heavy use treatments averaged near 30 pounds per acre per year, and the yearlong light use and the 1984 to 1987 light use rotated herd produced near 20 pounds per acre. Mean weaned calf production for the very light stocking and rotation through seven or eight pastures from 1988 to 1993 was 10 pounds per acre. Reducing the stocking rate and rotating through seven or eight pastures as compared to rotating

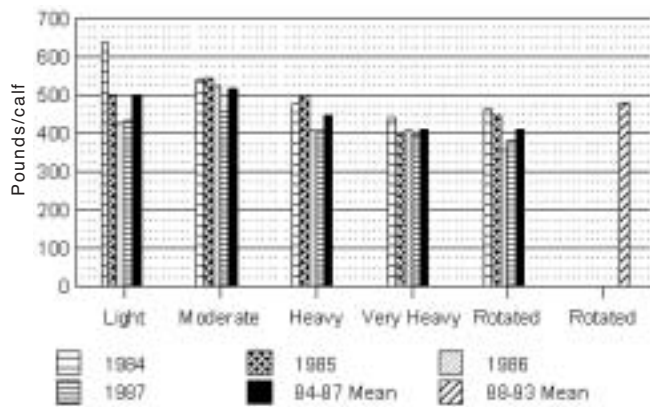

Figure 6—Calf weaning weights, pounds per calf.

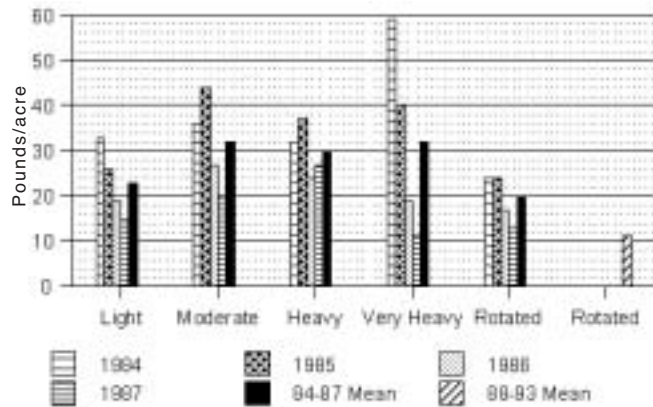

Figure 8—Calf weaning weights, pounds per acre.

through three seasonal pastures did improve individual calf weights (fig. 6), but production per acre was very poor (fig. 8).

Patch Grazing

Forage utilization within pastures was very patchy (areas of Lehmann lovegrass and other species utilized as much as 80 percent or more, especially under mesquite and on slopes of draws, dispersed among areas with little or no utilization) (fig. 9). Lehmann lovegrass produced new growth in these patch areas from early spring to late fall when moisture was present. During these grazing trials, cows selectively improved their nutritional intake by grazing in previously grazed patch areas, as reported by Ruyle in his paper presented at this symposium. Spot grazing in patches persisted throughout the grazing trials on all treatment pastures, except the yearlong very heavy use treatment and the summer use seasonal rotation pasture. In 1986, the yearlong very heavy use pasture (7 acres per AU) became one large, heavily grazed patch with little regrowth available for use. This pasture supported only light stocking rates in 1986 and 1987, indicating that heavy, repeated grazing in patch areas reduced potential forage production on these patch areas, even in a short term.

Patch Management

Stocking rates based on acres or average standing perennial grass production for the grazing trials reported in this paper provide little guidance for management decisions.



Figure 9—Patch utilization pattern for Lehmann lovegrass in pasture 2 after 4 years of light yearlong stocking.

Results indicate that the key to management of pastures dominated by Lehmann lovegrass is management of the grazed patches.

Cows slipped to later breeding or skipped a breeding during the later years of the 1984 to 1987 grazing trial for all treatments, especially the rotated treatment. Nutritional intake during the breeding season is known to influence cow breedback time after calving. New tiller growth in grazed patches provided improved nutrition, but repeated and heavy utilization of forage in these patches reduced the potential to produce adequate forage quantity.

The observation of use pattern for the summer use rotated pasture provides a clue to a possible strategy for management. By 1987 the summer use rotated pasture had become one large patch (fig. 10), but utilization was less than in the very heavy use pasture. High intake of green forage by cows in the summer, growing calves eating the green forage, high stocking density in a rotated pasture, and 4 consecutive years of summer grazing combined to account for the utilization pattern developed on this pasture.

A two-pasture rotation may be suitable for improving the quantity of high quality forage during spring in pastures that are dominated with Lehmann lovegrass. One pasture is grazed during the summer and fall season, and the second pasture is rested. Both pastures are then open for grazing during the winter and spring seasons. The second pasture is grazed during the second summer and the first is rested, and again both are open for use in the winter and spring. The objective is to increase the area of patches with higher stocking density in the summer pasture without stressing the livestock. During winter and spring, livestock have the opportunity to maximize forage selection for quality from the patches. The grazed patches are then provided rest every other summer to maintain plant vigor.



Figure 10—Uniform grazing use pattern for Lehmann lovegrass in pasture 3 after 4 years of grazing each summer to late fall.

Nathan B. English
David G. Williams
Jake F. Weltzin

Soil Temperature and Moisture Dynamics After Experimental Irrigation on Two Contrasting Soils on the Santa Rita Experimental Range: Implications for Mesquite Establishment

Abstract: We established a large-scale manipulative experiment in a semidesert grassland on the Santa Rita Experimental Range to determine how the recruitment and physiology of woody plants (*Prosopis velutina* Woot.) are affected by invasive grasses, seasonal precipitation regimes, and underlying soil characteristics. We established 72 2.8-m² plots beneath six large rainout shelters divided evenly between a clay-rich and a sandy loam soil less than 1 km apart. Monospecific stands of the invasive African grass *Eragrostis lehmanniana* and the native grass *Heteropogon contortus* were established into four plots each, and four plots were left bare under each shelter. Our watering protocol simulated 50 percent increases and decreases in average summer precipitation. Here we compare soil water content and temperature in *Eragrostis* and bare plots during a large, isolated irrigation event that we applied to the plots in June 2002. Daily average and maximum temperatures near the soil surface declined following the irrigation compared to nonirrigated, external plots, and were cooler for several days afterwards. Soil moisture contents declined and maximum soil temperatures increased more rapidly in plots dominated by *Eragrostis* than in bare plots. Near-surface soil temperatures are apparently too high for establishment of *Prosopis* seedlings in June prior to the onset of summer rains. *Eragrostis* may further prevent successful *Prosopis* establishment by shortening the period over which moisture and soil temperatures are suitable for germination and survival of *Prosopis* seedlings following a pulse of summer rain.

Acknowledgments: This project would not have been possible without the hard labor and invaluable input from Dayna Burns, Bill Cable, Michael Andregg, Susan Schwinning, Don Post, Alessandra Fravolini, Liegh Thomas, and many others at the University of Arizona and the University of Tennessee. I am grateful for the input and thoughtful reviews provided by Alessandra Fravolini and Kevin Hultine. This project was funded by USDA-CSREES Grant #00-35101-9308.

Introduction

The demography of woody plants within Southwestern savannas and grasslands is constrained by factors that affect seedling establishment and survival, and ultimately, recruitment of individuals into the population (Grubb 1977; Harper 1977; Hochberg and others 1994; McPherson 1997; Scholes and Archer 1997; Weltzin and McPherson 1999). On local scales, biotic (for example, neighboring individuals, herbivory) and edaphic factors and disturbance (for example, fire) are important determinants of vegetation patterns (Archer and others 1995; Prentice 1986). However, at larger scales abiotic constraints (for

Nathan B. English is a Research Specialist with the School of Renewable Natural Resources, 325 Biological Sciences East, University of Arizona, Tucson, AZ 85721; e-mail: nenglish@geo.arizona.edu. He completed a B.A. degree in geology at Colorado College and an M.S. degree in geosciences at the University of Arizona. David G. Williams is an Associate Professor in the Departments of Renewable Resources and Botany, University of Wyoming, Director of the University of Wyoming Stable Isotope Laboratory, and adjunct Associate Professor in the School of Renewable Natural Resources, University of Arizona. He completed a B.A. degree in botany at the University of Texas, Austin, an M.S. degree in range science at Texas A&M University, and a Ph.D. degree in botany at Washington State University. Jake F. Weltzin is an Assistant Professor in the Department of Ecology and Evolutionary Biology at the University of Tennessee, Knoxville. He completed a B.S. degree in forest and rangeland management at Colorado State University, an M.S. degree in rangeland science at Texas A & M University, and a Ph.D. degree in renewable natural resource studies at the University of Arizona.

In: McClaran, Mitchel P.; Ffolliott, Peter F.; Edminster, Carleton B., tech. coords. Santa Rita Experimental Range: 100 years (1903 to 2003) of accomplishments and contributions; conference proceedings; 2003 October 30–November 1; Tucson, AZ. Proc. RMRS-P-30. Ogden, UT: U.S. Department of Agriculture, Forest Service, Rocky Mountain Research Station.

example, regional or global climate change) may be more important than biotic constraints on woody plant establishment. In sum, woody plant population dynamics within any given grassland, savanna, or woodland are affected by the interaction between biotic and abiotic factors operating at a variety of spatial and temporal scales.

Using large rain-out shelters (fig. 1), we are investigating many of the factors that may determine the relative abundance and distribution of woody plants within grasslands and savannas of Western North America. Specifically, we are examining the effects of geomorphic/edaphic substrates, native versus nonnative grasses, and the seasonality of precipitation on the recruitment and physiology of mesquite (*Prosopis velutina* Woot.) and ecosystem gas exchange (net photosynthesis and transpiration). We anticipate that each of these factors will influence recruitment rates; however, interactions between these factors, and their relative contributions as constraints on recruitment, are more difficult to predict.

Global temperatures are predicted to increase from 1.4 to 5.8 °C during this century and will likely alter patterns of precipitation over much of the Earth (IPCC 2001). The ecological effects of changing precipitation and temperature regimes will be particularly dramatic in arid and semiarid environments, where water availability most limits the ecosystem productivity and function (Noy-Meir 1973; Weltzin and McPherson 2003). In the Southwestern United States, two different regional climate models predict increased temperatures, but predict very different changes in the amount and timing of precipitation. The Regional Circulation Model (RegCM) of Giorgi and others (1998) predicts a decrease in the amount of winter precipitation and an increase in summer precipitation. In contrast, the Hadley Circulation Model 2 (HADCM2) developed by the Hadley Centre for Climate Prediction and Research, UK Meteorological Office (NAST 2000), predicts that by 2030 the Southwest will experience drier summers and wetter winters.

Soil temperature, and the effect of precipitation on soil temperature, can influence the germination rate and survival of woody species that grow in semiarid and arid environments (Scifres and Brock 1969). In southern Arizona, maximum daily, near-surface (0.5 cm) soil temperatures frequently exceed 50 °C and have been measured up to 61 °C (Cable 1969). After scarification, mesquite seeds require both moisture and an optimal temperature (29 °C) to emerge and survive on the soil surface (Scifres and Brock 1969). During the summer monsoon, precipitation increases soil moisture and decreases soil temperatures at the surface (Abbot 1999). The soil dries and returns to prerin temperatures very rapidly following a single rain event, leading to seedling death if the seedling has not had time to establish roots in deeper soil layers. Therefore, changes in the frequency of precipitation will likely have direct impacts on recruitment of mesquite by regulating soil temperature and moisture during the summer months. Here we present data that suggests a decrease in the frequency of summer precipitation, or the presence of *Eragrostis*, may lead to longer periods between rain events over which soil temperature is above the optimal range for *Prosopis* seedling recruitment on the Santa Rita Experimental Range.

Methods and Materials

Site Description

Our rainout shelters are located on two sites 1 km apart (N 31.78°, W 110.88°) on the Santa Rita Experimental Range. Three shelters each were constructed on middle-Holocene (4-8 ka) and late-Pleistocene (200-300 ka) alluvial fan surfaces (McAuliffe 1995). The middle Holocene soil is a loamy coarse sand, while the Pleistocene soil contains up to 50 percent clay beneath a shallow (0 to 25 cm) sandy loam surface. Both sites are on gentle slopes (2 percent) at about 1,100 m elevation.



Figure 1—Shelter (9 by 18 m, 4 m tall) on the Pleistocene site; open sides are 1.5 m off the ground. Tall grasses visible beneath the shelter are *Heteropogon contortus*. Note the cables attached to the shelter and steel fenceposts for greater wind stability, and polypropylene rope holding down the plastic cover.

Shelter and Plot Installations

In April and May 2001, we established twelve 1.5- by 1.8-m plots in each of three shelters on Holocene and Pleistocene surfaces (72 plots total). The 12 plots in each shelter were randomly assigned to one of three vegetation cover treatments (*Heteropogon contortus* (L.) Beauv., *Eragrostis lehmanniana* Nees., or bare) and one of two precipitation treatments (50 percent wetter than average in summer, 50 percent drier than average in summer). In June and July of 2001, we carefully removed all aboveground vegetation from plot surfaces and transferred 56 greenhouse-grown grass seedlings into the appropriate grass plot (in a regular grid with about 20 cm spacings, 21 plants per m²). We trenched each plot to >0.75 m depth (40 cm wide), leaving a pedestal of soil (2.7 m², > 2 m³). Time-domain reflectometry probes (Ledieu and others 1986; Risler and others 1996; TDR) that measure soil volumetric water content (Θ_v) of soil were installed horizontally into the side of each plot at 15, 35, and 55 cm depths. After TDR installation, the trench faces were lined with black 6-mil PVC film attached to wooden frames (10 cm tall) that sit at ground level. The plastic and frames were designed to prevent horizontal subsurface flow out of the plots and surface runoff to and runoff from the plots. Twenty-gauge, copper-constantan thermocouples (0.5 cm long and epoxy coated) were installed at 2 and 10 cm soil depth to measure soil temperature in two *Eragrostis* plots, two bare plots, and one unwatered and one bare plot outside the shelters (as controls) on each site. Care was taken to bury the first 10 cm behind the thermocouple junction at a depth equal to the desired measurement depth to prevent heat from direct sunlight on the wire from travelling along the cable to the thermocouple junction.

Data collection

A datalogger (CR-10X, Campbell Scientific, Logan, UT) connected to the soil thermocouples was used to measure temperature every 15 minutes and averaged hourly from June 10 to June 21, 2002. To account for variations in thermocouple temperatures and reduced radiative load on soils under the shelters caused by interception of light by the shelters (less than several degrees Celsius), we cross-calibrated experimental plot thermocouples to thermocouples at the same depth in the control plots. We cross-calibrated the thermocouples at a time when we expected soil temperature in and outside the shelters to be similar (a daily mean temperature on June 25, 2002). We used a commercially available cable tester (TDR100, Campbell Scientific) connected to a portable battery and computer to measure Θ_v from the TDR probes in the field. We determined the average bulk-density and the rock-fragment fraction from each site at the relevant depths to convert Θ_v to gravimetric water content (Θ_g).

Irrigation

Our precipitation protocols were designed to test the influence of seasonal precipitation amount and pattern on production, composition, and demography of grasses and, at a later date, establishment of woody plants. For the soil

temperature and moisture data presented in this paper, we applied the rainfall equivalent of 39 mm of water to each plot on the evening of June 10, 2002. Water at 26 °C was applied manually at a rate of about 28 l min⁻¹ and measured with a digital totalizer (accuracy \pm 1.5 percent) connected to a gas-powered water pump.

Results and Discussion

While scarification, ample moisture, and a thin layer of soil are prerequisites for *Prosopis* seedling establishment, soil temperature also exerts a strong influence (Scifres and Brock 1969, 1972). Scifres and Brock (1969) found that the optimum temperatures for establishment of honey mesquite (*Prosopis glandulosa* Torr. var *glandulosa*) seedlings were 29 °C, and that temperatures below 21 °C and above 38 °C led to reduced emergence rates and greater sensitivity to soil moisture stress. Although mesquite may germinate at temperatures greater than 38 °C, they will not survive in these temperatures for more than 10 days at soil water potentials less than -0.2 MPa (Scifres and Brock 1969). Typically, our research plots on the Holocene and Pleistocene soils reach this moisture threshold at Θ_g values of 5 percent and 9 percent, respectively (Schwinning, unpublished data).

Prior to watering in early June, mean daily soil temperatures on both sites at 2 cm were about 37 °C, and maximum daily temperatures at 2 cm exceeded 42 °C and ranged up to 53 °C (fig. 2). These temperatures are consistent with temperatures measured on a Holocene site by Cable (1969) and are well above the optimum seedling establishment temperature for *Prosopis*. Gravimetric soil moisture content (Θ_g) at 15 cm was less than 1 percent on the Holocene plots, and was 9 percent and 6 percent on bare and *Eragrostis* plots, respectively, on the Pleistocene plots prior to irrigation. For all plots, Θ_g measured at 15 cm was likely higher than at 2 cm depth.

The watering event reduced soil temperatures and increased Θ_g on all plots, but soil temperatures and Θ_g recovered to prewatering values more quickly on *Eragrostis* plots (fig. 2) than on bare plots. Mean daily soil temperatures on both sites remained near the optimum seedling recruitment temperature (29 °C) for less than 2 days. Watering reduced both maximum and mean daily soil temperatures on the Holocene and Pleistocene soils at 2 cm by up to 20 and 11 °C, respectively, compared to the control plots. Recovery of mean temperatures to >30 °C occurred within 2 days after the precipitation event on vegetated and bare plots regardless of site or the presence or absence of *Eragrostis*. Recovery of daily maximum temperatures to within 20 percent of that in the control plot occurred 3 days after the pulse on both sites. *Eragrostis* plots returned to higher maximum daily temperatures more quickly than did bare plots. Reductions of maximum daily soil temperature in bare plots was observed beyond the 12-day duration of the experiment. Patterns of rewarming at 10 cm depth are similar, but generally occur 1 to 2 days later than at 2 cm.

Gravimetric water content (Θ_g) varied by vegetative treatment and site. Θ_g exceeded 5 percent after watering in both treatments on the Holocene and 9 percent in Pleistocene bare plots for 2 days (fig. 2). Θ_g exceeded 9 percent for the duration of the experiment on Pleistocene bare plots. Although Θ_g in the Pleistocene bare plots was higher (9 percent) than in vegetated plots (6 percent) before the watering

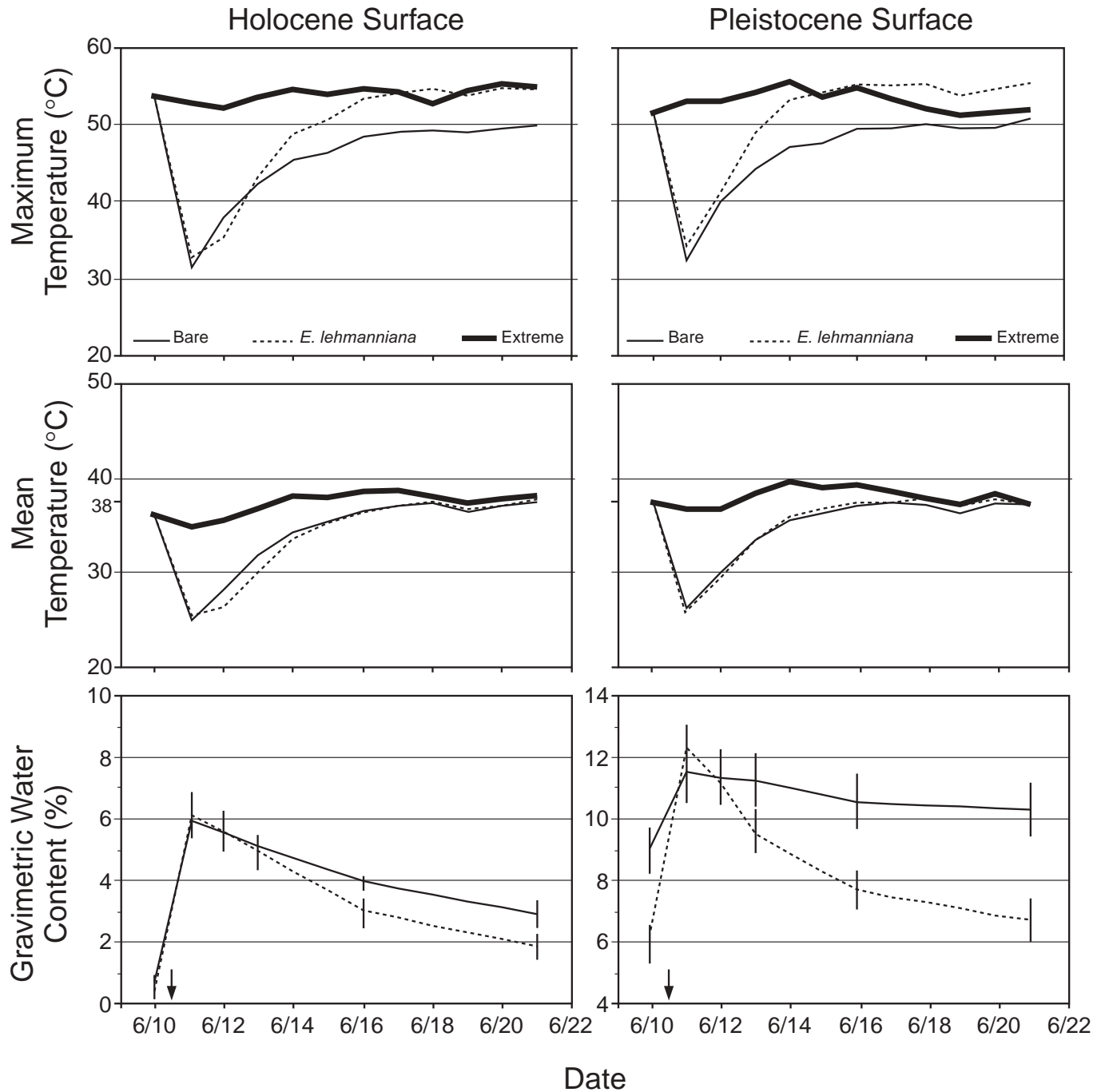

Figure 2—Maximum and mean daily soil temperature at 2 cm depth for Holocene and Pleistocene plots (bare, $n = 2$; *Eragrostis lehmanniana*, $n = 2$; external $n = 1$) and gravimetric water content (Θ_g) at 15 cm depth. Arrow indicates the application of a 39 mm rainfall equivalent water pulse added to the plots between 4 p.m. and 10 p.m. on June 10, 2002. Vertical lines on Gravimetric Water Content graphs represent ± 1 standard error ($n > 9$).

pulse was applied, both plots had comparable Θ_g (12 percent) immediately following the water addition. Two days after watering, Θ_g in *Eragrostis* plots on both sites was lower than in bare plots at the same site. Six days after watering, Θ_g in *Eragrostis* plots was 1 percent and 3 percent lower than in bare plots on the Holocene and Pleistocene, respectively.

Soil temperatures in excess of 29 °C and very dry soils in late spring and early summer on the SRER make *Prosopis*

seedling establishment during this time very difficult. Our data suggest that (1) infrequent storm events in late spring and early summer, while triggering seed germination, will neither wet nor cool the soil at 2 cm or shallower for a long enough period of time to allow for successful seedling establishment; and (2) *Eragrostis* appears to rapidly take up soil moisture and drive maximum daily temperatures up, and reduce the period of time soils remain at optimal temperatures

for seedling establishment. Our continuing studies will test the hypothesis that while mean soil temperatures above 21 °C in the upper 2 cm occur between April and October on the SRER, mean soil temperatures over 35 °C coupled with low soil moisture prevent seedling establishment until the onset of the monsoon, when frequent rains consistently wet soils and reduce soil temperatures to the optimum temperature for seedling establishment.

Conclusions

We instrumented several bare and grass-covered plots, and a bare external control plot, on two different soil types with TDR probes and thermocouples at various depths to measure the effect that a pulse of precipitation would have on maximum and mean daily soil temperatures. After an artificially applied precipitation pulse, maximum daily soil temperatures at 2 cm on both sites were depressed by up to 20 °C, and mean temperatures remained near the optimal temperature range (29 °C) for seedling recruitment several days after the pulse. Within 3 to 4 days, mean daily temperatures of soils on both sites had returned to within 20 percent of that in the control plots and well beyond the optimal temperature range for seedling recruitment. Average temperatures in late spring and the premonsoon months are too high for successful *Prosopis* establishment, despite infrequent rains. *Eragrostis* reduces soil moisture and drives up maximum daily temperatures compared to that in bare plots.

References

- Abbot, Laurie B. 1999. Effects of planting date and species choice on the fate of planted warm-season perennial grass seeds: implications for revegetation. Tucson: University of Arizona. Thesis.
- Archer, S. A.; Schimel, D. S.; Holland, E. A. 1995. Mechanisms of shrubland expansion: land use or CO₂? *Climatic Change*. 29: 91–99.
- Cable, Dwight R. 1969. Soil temperature variations on a semi-desert habitat in southern Arizona. Res. Note RM-128. Fort Collins, CO: U.S. Department of Agriculture, Forest Service, Rocky Mountain Forest and Range Experiment Station. 4 p.
- Giorgi F.; Mearns, L. O.; Shields, C.; McDaniel, L. 1998. Regional nested model simulations of present day and 2xCO₂ climate over the Central Plains of the United States. *Climatic Change*. 40: 457–493.
- Grubb, P. J. 1977. The maintenance of species richness in plant communities: the importance of the regeneration niche. *Biological Review*. 52: 107–145.
- Harper, J. L. 1977. *Population biology of plants*. London, UK: Academic Press. 892 p.
- Hochberg, M. E.; Menaut, J. C.; Gignoux, J. 1994. The influences of tree biology and fire in the spatial structure of the West African savanna. *Journal of Ecology*. 82: 217–226.
- International Panel on Climate Change. 2001. Summary for policymakers (SPM) and technical summary (TS). In: Houghton, Ding Y.; Griggs, D. J.; Noguer, M.; van der Linden, P. J.; Xiaosu, D., eds. *Climate change 2001: the scientific basis*. Cambridge, UK: Cambridge University Press. 98 p.
- Ledieu, J.; Deridder, P.; DeClerck, P.; Dautrebande, S. 1986. A method of measuring soil moisture by time-domain reflectometry. *Journal of Hydrology*. 88: 319–328.
- McAuliffe, Joseph R. 1995. Landscape evolution, soil formation, and Arizona's desert grasslands. In: McClaran, M. P.; Van Devender, T. R., eds. *The desert grassland*. Tucson: University of Arizona Press: 100–129.
- McPherson, Guy R. 1997. *Ecology and management of North American savannas*. Tucson: University of Arizona Press. 208 p.
- National Assessment Synthesis Team. 2000. *Climate change impacts on the United States: the potential consequences of climate variability and change. Overview*. U.S. Global Change Research Program. Cambridge, UK: Cambridge University Press. 154 p.
- Noy-Meir, I. 1973. Desert ecosystems: environment and producers. *Annual Review of Ecology and Systematics*. 4: 25–51.
- Prentice, I. C. 1986. Vegetation responses to past climatic variation. *Vegetatio*. 67: 131–141.
- Risler, P. D.; Wraith, J. M.; Gaber, H. M. 1996. Solute transport under transient flow conditions estimated using time domain reflectometry. *Soil Science Society of America Journal*. 60: 1297–1305.
- Scholes, R. J.; Archer, S. R. 1997. Tree-grass interactions in savannas. *Annual Review of Ecology and Systematics*. 28: 517–544.
- Scifres, C. J.; Brock, J. H. 1969. Moisture temperature interrelations in germination and early seedling development of mesquite. *Journal of Range Management*. 22: 334–337.
- Scifres, C. J.; Brock, J. H. 1972. Emergence of honey mesquite seedlings relative to planting depth and soil temperature. *Journal of Range Management*. 25: 217–219.
- Weltzin, J. F.; McPherson, G. R. 1999. Facilitation of conspecific seedling recruitment and shifts in temperate savanna ecotones. *Ecological Monographs*. 69: 513–534.
- Weltzin, J. F.; McPherson, G. R. 2003. *Changing precipitation regimes and terrestrial ecosystems: a North American perspective*. Tucson: University of Arizona Press.

New Data Sources and Derived Products for the SRER Digital Spatial Database

Abstract: The Santa Rita Experimental Range (SRER) digital database was developed to automate and preserve ecological data and increase their accessibility. The digital data holdings include a spatial database that is used to integrate ecological data in a known reference system and to support spatial analyses. Recently, the Advanced Resource Technology (ART) facility has added three new Federal geographic data products to this spatial database. U.S. Geological Survey (USGS) digital raster graphics (DRG) are scanned images of USGS topographic maps. Digital orthophoto quarter quads (DOQQ) are computer-generated images of aerial photographs that have been registered to a coordinate system and ortho-rectified. Digital elevation models (DEM) are georeferenced arrays of regularly spaced elevation values. A product description, production methodology discussion, and file format description is provided for each product. The applications of these products include reference mapping, spatial analysis, and data visualization. A sample image of each of these products is provided. These data represent an ongoing commitment to providing researchers with accurate, up-to-date, and relevant data products to support research on the SRER. Products that will be derived from these sources include slope aspect, land slope, and hillshade layers. Improved Federal geographic data products will be added to the database as they become available.

Keywords: digital databases, Federal geographic data products, SRER database

Santa Rita Experimental Range Digital Database

Ecological data have been collected at the Santa Rita Experimental Range (SRER) since its establishment in 1903, distinguishing it as the oldest continuously operating range experiment station in the world with a long-term data record that is unsurpassed in the Southwestern United States (McClaran and others 2002). The SRER digital database was developed to preserve these data and to increase their accessibility. The database includes precipitation measurements, vegetation measurements, plant synonymy tables for taxonomic groups, repeat ground photography, an annotated bibliography, and a collection of spatial data. The SRER spatial database is developed and maintained at the Advanced Resource Technology (ART) facility housed in the School of Renewable Natural Resources in the College of Agriculture and Life Sciences. The goal of the SRER spatial database project is to integrate site-based data with referenced spatial locations and to provide source and derived spatial data layers to support spatial analyses.

Existing Spatial Data

The spatial database provides information to create maps of four types: (1) human structures and boundaries, (2) topography and elevation, (3) soil and ecological sites, and (4) locations of permanent transects established in previous Forest Service studies and those still being remeasured at 3-year intervals. All currently available spatial data is downloadable in ARC/INFO export file format (*.e00) (McClaran and others 2002). The digital elevation models (DEMs) now available in the database are 30-m resolution for the four U.S. Geological Survey (USGS) 7.5-minute quadrangles covering the SRER.

Craig Wissler is an Assistant Professor of renewable natural resources in the School of Renewable Natural Resources, 325 Biological Sciences East, University of Arizona, Tucson, AZ 85721; e-mail: craig@srnr.arizona.edu. He is also Director of the Advanced Resource Technology (ART) facility in the College of Agriculture and Life Sciences. Craig holds a B.S. degree in environmental resources in agriculture from Arizona State University and a Master of Landscape Architecture degree from the University of Arizona. Deborah Angell is the Data Manager for the National Park Service Sonoran Desert Network Natural Resources Inventory and Monitoring Program. She is also a part-time Senior Research Specialist in the University of Arizona's School of Renewable Natural Resources. Deborah earned a B.S. degree in renewable natural resources and an M.S. degree in range management from the University of Arizona.

In: McClaran, Mitchel P.; Ffolliott, Peter F.; Edminster, Carleton B., tech. coords. Santa Rita Experimental Range: 100 years (1903 to 2003) of accomplishments and contributions; conference proceedings; 2003 October 30–November 1; Tucson, AZ. Proc. RMRS-P-30. Ogden, UT: U.S. Department of Agriculture, Forest Service, Rocky Mountain Research Station.

New Spatial Data Products

Recently, three additional geographic data products for the SRER study area have become available from the Federal Government for inclusion in the SRER spatial database. Digital raster graphics (DRGs), digital orthophoto quarter quads (DOQQs), and higher resolution (10-m) DEMs will be available for the Corona de Tucson, Green Valley, Helvetia, and Sahuarita quadrangles. These products are valuable additions to the database for their potential use in research applications.

Digital Raster Graphics (DRG)

A DRG is a scanned image of a USGS topographic map, including all map collar information. Only the portion of the image inside the neatline is georeferenced to the Earth's surface. A standard palette of 13 colors, modeled after the line-drawing nature of the source map, is used for consistency among all DRGs (U.S. Department of the Interior; U.S. Geological Survey 2002b). The USGS has produced DRGs at scales from 1:20,000 to 1:125,000.

A DRG is produced by scanning a printed map at a minimum of 250 dots per inch (dpi) with a high-resolution scanner. The digital image is georeferenced to true ground coordinates and fit to the Universal Transverse Mercator (UTM) projection, which provides consistency with DOQQs and digital line graphs (DLGs). DRGs can reference either the North American Datum of 1927 (NAD 27) or the North American Datum of 1983 (NAD 83). In most cases, the DRG is referenced to the same datum as the source map; thus, a DRG produced from a paper map referenced to NAD 27 will also be referenced to NAD 27. Colors are standardized, and the image is compressed to reduce file size. The horizontal positional accuracy of a DRG is approximately equal to the accuracy of the source map. For example, a 1:24,000 DRG scanned at 250 dpi has a ground sample distance of 2.4 m (U.S. Department of the Interior; U.S. Geological Survey 2002b). The DRGs available in the SRER digital database are eight-bit palette-color images in the GeoTIFF format. Figure 1 displays a portion of a DRG zoomed to the area surrounding Huerfano Butte.

A DRG is perhaps most useful as a backdrop for other spatial data. For example, an image combining the DRG

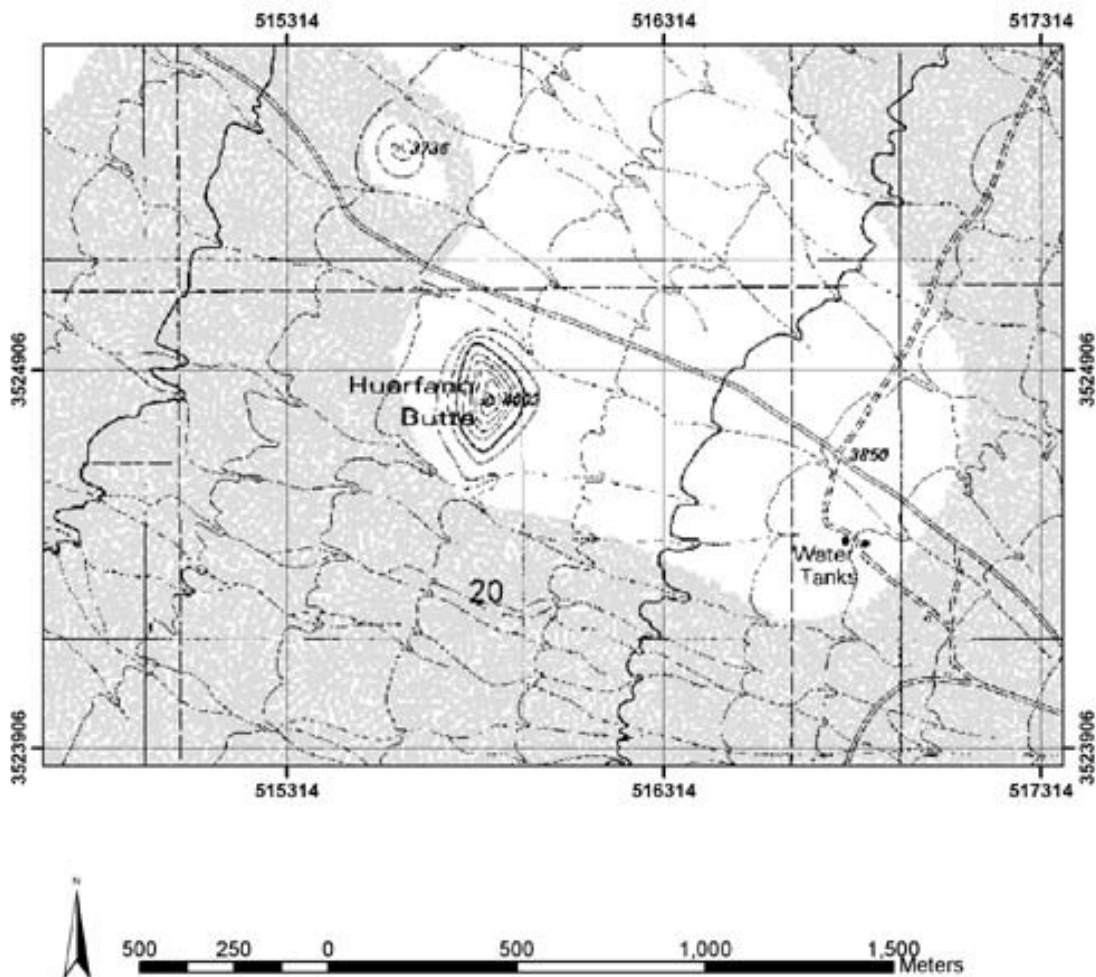

Figure 1—A portion of a USGS digital raster graphic from the Helvetia 7.5-minute quadrangle.

with DOQQs is useful for collecting and revising digital map data. A shaded relief map created by combining a DRG and a DEM provides additional details for viewing, extracting, and revising map information (U.S. Department of the Interior; U.S. Geological Survey 2002b).

Digital Orthophoto Quarter Quads (DOQQ)

A DOQQ is a computer-generated image of an aerial photograph with the effects of camera tilt and topographic relief removed to create a uniform-scale orthophoto. It combines the image characteristics of a photograph with the geometric qualities of a map. The files include an ASCII header that contains data for identifying, displaying, and georeferencing the image. To facilitate the spatial referencing of other spatial data to the DOQQ, both North American Datum of 1927 (NAD 27) and North American Datum of 1983 (NAD 83) coordinates for the upper left pixel are contained in the header (U.S. Department of the Interior; U.S. Geological Survey 2002a). DOQQs are available as black and white, color, or color infrared images with a 1-m resolution.

A DOQQ is created by scanning an aerial photograph transparency at high resolution. The aerial photo should be a quarter-quadrangle centered image that meets the standards of the National Aerial Photography Program (NAPP). The digital image is then ortho rectified using computerized mathematics to generate an orthophoto. The orthophoto is put into the Universal Transverse Mercator (UTM) projection and referenced to NAD 83 (U.S. Department of the Interior; U.S. Geological Survey 2002a).

The source of the DOQQs included in the SRER database is aerial photography taken by NAPP in 1996. Each DOQQ is a color infrared (CIR) image with 1-m resolution in the GeoTIFF format, representing an area of 3.75 minutes longitude by 3.75 minutes latitude with a 50- to 300-m overlap between adjacent images to facilitate tonal matching and mosaicking. The CIR images were produced for areas in southern Arizona, including the SRER. Average file size of a 3.75-minute CIR DOQQ is 11 megabytes (U.S. Department of the Interior; U.S. Geological Survey 2002a). Figure 2 displays a portion of a DOQQ zoomed to the area surrounding Huerfano Butte.

Any geographic information system (GIS) that can manipulate raster images can incorporate DOQQs. A DOQQ

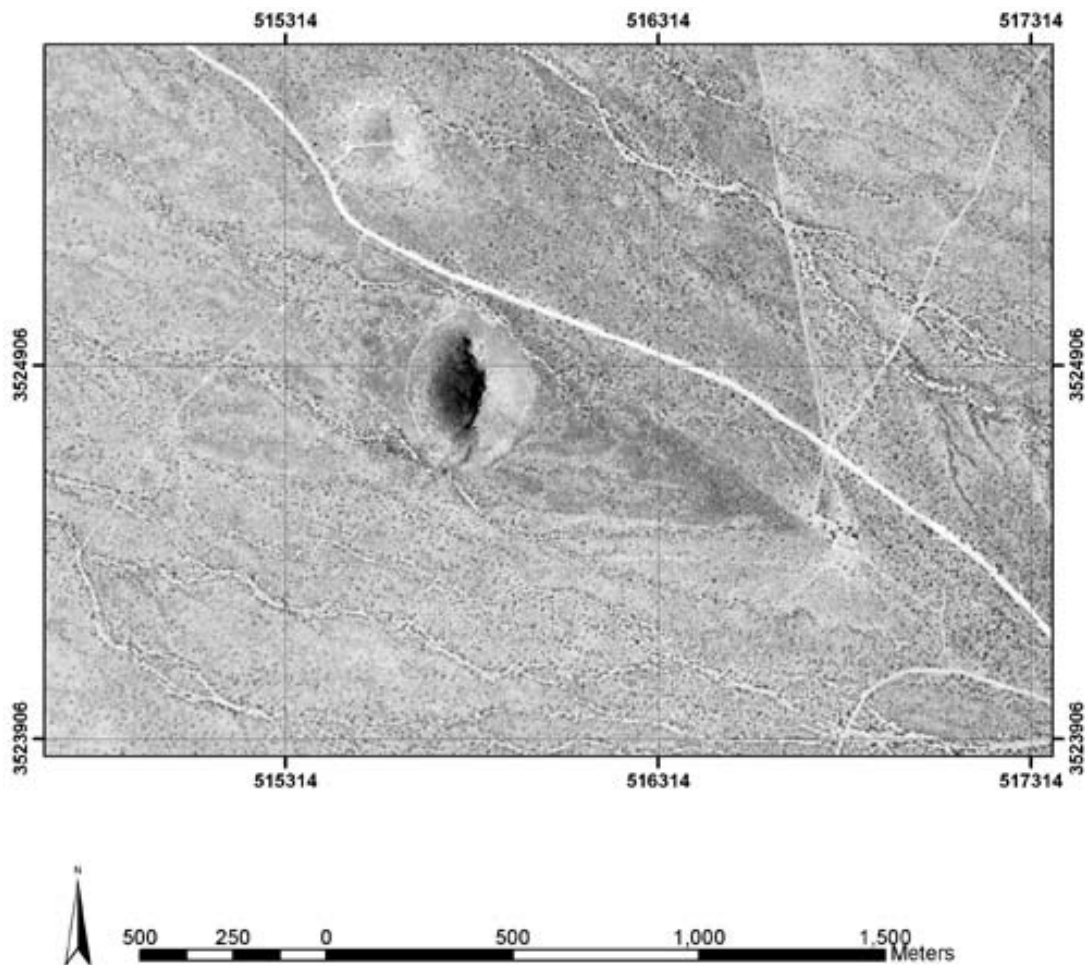

Figure 2—A portion of a digital orthophoto from the Helvetia 7.5-minute quadrangle showing Huerfano Butte.

may be used as a base layer for displaying and modifying associated spatial data, as well as evaluating data for completeness and accuracy, particularly on DLGs (U.S. Department of the Interior; U.S. Geological Survey 2002a). Color infrared (CIR) DOQQs include the near infrared band and may be processed to identify actively growing vegetation.

Digital Elevation Models (DEM)

A DEM is a georeferenced array of regularly spaced elevation values at a 30-m or 10-m resolution. The grid cells are regularly spaced along south to north profiles ordered from west to east. The USGS produces five types of DEMs ranging from 7.5-minute to 1-degree maps (U.S. Department of the Interior; U.S. Geological Survey 2002c).

A 7.5-minute DEM (corresponding to a USGS 7.5-minute topographic quadrangle map) is created by interpolation using either photogrammetric sources or vector data DLG hydrographic (stream channel) and hypsographic (elevations represented as contours) data. The DEM is horizontally referenced to the UTM projection and either the NAD 83 or NAD 27 datum and vertically referenced to the North American Vertical Datum of 1929 (NAVD 29). The horizontal accuracy of 7.5-minute DEMs derived from vector or DLG source data must have a root-mean-square error (RMSE) of one-half of a contour interval or better. For 7.5-minute DEs

derived from a photogrammetric source, 90 percent have a vertical accuracy of 7-m RMSE or better, and 10 percent are in the range of 8 to 15 m. For 7.5- and 15-minute DEMs derived from vector or DLG hypsographic and hydrographic source data, an RMSE of one-half of a contour interval or better is required (U.S. Department of the Interior; U.S. Geological Survey, 2002c).

The DEMs available from the SRER digital base are 10-m resolution in the Spatial Data Transfer Standard (SDTS) format. This format allows the transfer of georeferenced spatial data with potentially no loss of information between dissimilar computer systems (U.S. Department of the Interior; U.S. Geological Survey 2000). DEM files are approximately 9.9 megabytes for the 7.5-minute coverage. Figure 3 displays a portion of a 10-m DEM with hypsographic shading zoomed to the area surrounding Huerfano Butte.

A variety of products may be derived from DEMs. Maps displaying slope percent or degrees of slope can be in spatial analyses. A map displaying aspect could be used to infer vegetation types in areas where north- and south-facing slopes are characterized by different plant species. The accuracy of a vector stream layer could be visually checked by overlaying it on a hillshade map. DEMs form the basis for many hydrologic models that are used to predict runoff and estimate erosion potential. Drainage networks can also be derived from DEMs.

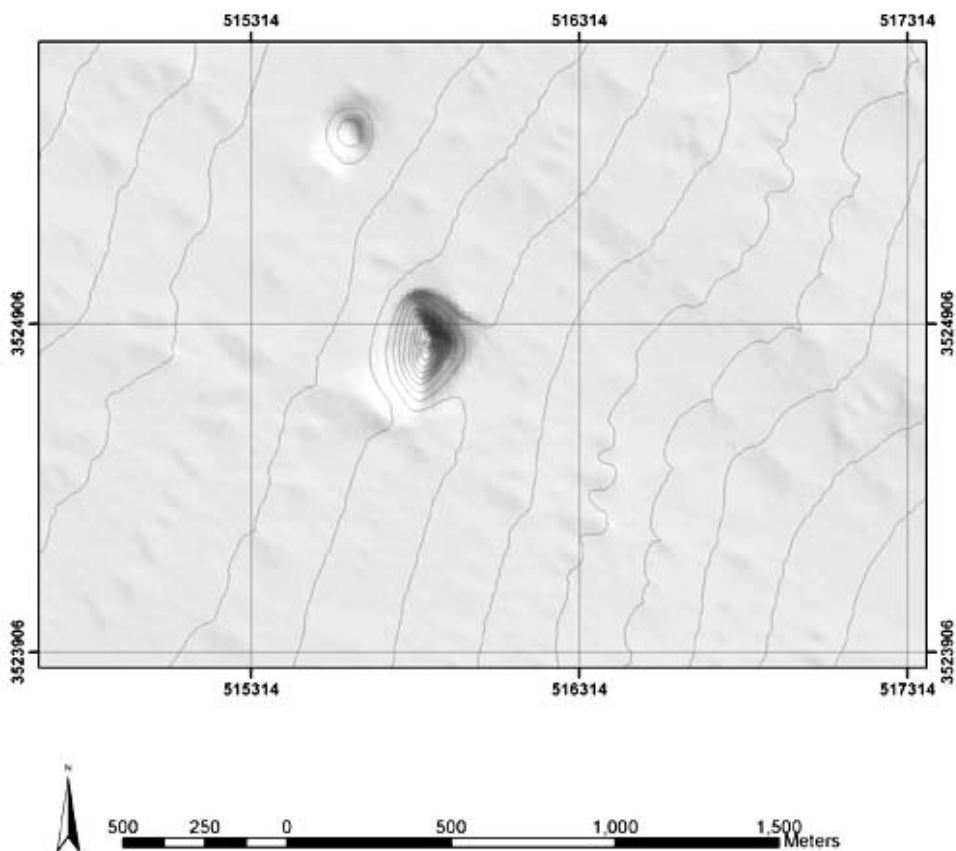

Figure 3—A portion of a 10-m digital elevation model of the area surrounding Huerfano Butte displayed as a hillshade with 10-m contour lines.

Future Plans

The addition of these new Federal geographic data products represents a commitment toward the project goal of providing spatial data for reference and spatial analyses. The current project plans for the spatial database include the update of Federal geographic data products and development of standard products derived from the DEMs and DOQQs. As funding permits, standard product development from the DEMs will include land slope data, slope aspect data, and hillshade images. The land slope and slope aspect data will add to the utility of the spatial database, as these themes are commonly used in spatial analyses. The CIR DOQQs will be processed into false color images using green color to show actively growing vegetation. These images may be used as reference themes in cartographic products, or as a product for input into further image processing applications.

The National Elevation Dataset (NED) is a new raster product produced by the USGS to provide seamless DEM data for entire country (U.S. Department of the Interior; U.S. Geological Survey 2002d). The NED represents an effort by the USGS to respond to the need for seamless topographic data that has been processed to remove slivers, artifacts, and other abnormalities. Although originally developed at a resolution of 1 arc-second (about 30 m), the USGS is in the process of completing the incorporation of the 10-m DEMs into NED for southern Arizona. As the 10-m data for the SRER quadrangles becomes available, it will be added to the spatial database. The 10-m NED will provide for improved surface modeling for hydrological applications.

References

- McClaran, Mitchel P.; Angell, Deborah L.; Wissler, Craig. 2002. Santa Rita Experimental Range digital database: user's guide. Gen. Tech. Rep. RMRS-GTR-100. Ogden, UT: U.S. Department of Agriculture, Forest Service, Rocky Mountain Research Station. 13 p.
- U.S. Department of the Interior; U.S. Geological Survey. 2002a. (December 31-last update). USGS, [Online]. Available: <http://mac.usgs.gov/mac/isb/pubs/factsheets/fs05701.html> [2002, December 31]. Digital Orthophoto Quadrangles Fact Sheet 057-01 [Online]. (2001, May). USGS Eastern Region Geography (page maintainer).
- U.S. Department of the Interior; U.S. Geological Survey. 2002b. (December 31-last update). USGS, [Online]. Available: <http://mac.usgs.gov/mac/isb/pubs/factsheets/fs08801.html> [2002, December 31]. USGS GeoData Digital Raster Graphics Fact Sheet 088-01 [Online]. (2001, September). USGS Eastern Region Geography (page maintainer).
- U.S. Department of the Interior; U.S. Geological Survey. 2002c. (December 31-last update). USGS, [Online]. Available: <http://mac.usgs.gov/mac/isb/pubs/factsheets/fs04000.html> [2002, December 31]. US GeoData Digital Elevation Models Fact Sheet 040-00 [Online]. (2000, April). USGS Eastern Region Geography (page maintainer).
- U.S. Department of the Interior; U.S. Geological Survey. 2002d. (November 6-last update). USGS, [Online]. Available: <http://gisdata.usgs.net/NED/About.asp> [2002, November 6]. National Elevation Dataset [Online]. (2002, November). USGS (page maintainer).
- U.S. Department of the Interior; U.S. Geological Survey. 2000. (February 14-last update). USGS, [Online]. Available: <http://mcmcweb.er.usgs.gov/sdts/whatsdts.html> [2000, February 14]. What is SDTS? [Online]. sdts@usgs.gov (page maintainer).

Pesticide Precautionary Statement

This publication reports research involving pesticides. It does not contain recommendations for their use, nor does it imply that the uses discussed here have been registered. All uses of pesticides must be registered by appropriate State and/or Federal agencies before they can be recommended.

CAUTION: Pesticides can be injurious to humans, domestic animals, desirable plants, and fish or other wildlife—if they are not handled or applied properly. Use all pesticides selectively and carefully. Follow recommended practices for the disposal of surplus pesticides and pesticide containers.



This publication reports research involving pesticides. It does not contain recommendations for their use, nor does it imply that the uses discussed here have been registered. All uses of pesticides must be registered by the appropriate State and/or Federal agencies before they can be recommended. CAUTION: Pesticides can injure humans, domestic animals, desirable plants, fish, and wildlife if they are not handled or applied properly. Use all pesticides selectively and carefully. Follow recommended practices for the disposal of surplus pesticides and their containers.

The use of trade or firm names in this publication is for reader information and does not imply endorsement by the U.S. Department of Agriculture of any product or service



The Rocky Mountain Research Station develops scientific information and technology to improve management, protection, and use of the forests and rangelands. Research is designed to meet the needs of National Forest managers, Federal and State agencies, public and private organizations, academic institutions, industry, and individuals.

Studies accelerate solutions to problems involving ecosystems, range, forests, water, recreation, fire, resource inventory, land reclamation, community sustainability, forest engineering technology, multiple use economics, wildlife and fish habitat, and forest insects and diseases. Studies are conducted cooperatively, and applications may be found worldwide.

Research Locations

Flagstaff, Arizona
Fort Collins, Colorado*
Boise, Idaho
Moscow, Idaho
Bozeman, Montana
Missoula, Montana
Lincoln, Nebraska

Reno, Nevada
Albuquerque, New Mexico
Rapid City, South Dakota
Logan, Utah
Ogden, Utah
Provo, Utah
Laramie, Wyoming

*Station Headquarters, 240 West Prospect Road, Fort Collins, CO 80526

The U.S. Department of Agriculture (USDA) prohibits discrimination in all its programs and activities on the basis of race, color, national origin, sex, religion, age, disability, political beliefs, sexual orientation, or marital or family status. (Not all prohibited bases apply to all programs.) Persons with disabilities who require alternative means for communication of program information (Braille, large print, audiotape, etc.) should contact USDA's TARGET Center at (202)-720-2600 (voice and TDD).

To file a complaint of discrimination, write USDA, Director, Office of Civil Rights, Room 326-W, Whitten Building, 1400 Independence Avenue, SW, Washington, DC 20250-9410 or call (202)-720-5964 (voice or TDD). USDA is an equal opportunity provider and employer.